



**FORD PERFORMANCE
PARTS**

Power For The People!

A Full Line of Performance
Crate Engines



MORE GALLOP FOR YOUR PONY

Everything from Superchargers to Exhaust Systems

\$5.00 USD

2020 CATALOG

2.3L ECOBOOST®
M-6007-23TA

310 HP



X2-347CI
M-6007-X2347DR

360 HP



572CI BIG BLOCK
M-6007-572DF

655 HP



GEN3 5.0L COYOTE
M-6007-M50C

460 HP



GEN2 COYOTE POWER MODULE
M-9000-PMCM

435 HP



5.2L ALUMINATOR
M-6007-A52XS

580 HP



ENGINEERED. TESTED. CRATED.

For more than 35 years Ford Performance Parts has been producing and developing performance parts with enthusiasts in mind. Whether you are building from the ground up or working to get that extra tenth of a second Ford Performance delivers the products you need. We're proud to offer a range of crate engines suitable for a variety of applications and performance components that are designed and engineered to rigorous Ford Performance standards. As a result, our parts and components are proudly affixed with the Ford Oval.

FIND ALL THE POWER YOU NEED AT
PERFORMANCEPARTS.FORD.COM





2020 PERFORMANCE PARTS CATALOG HIGHLIGHTS

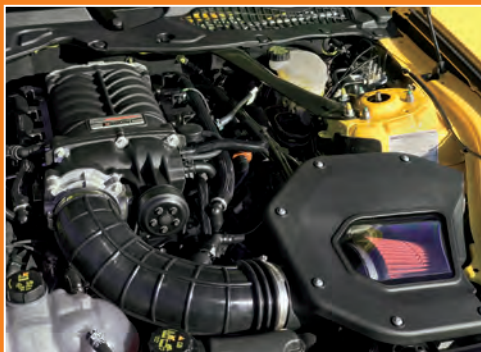

SUPERCHARGERS

Page 7

Superchargers from Ford Performance Parts not only deliver a significant boost in horsepower, but are Ford Performance validated, street-legal and emissions-certified as well.



FOX "TUNED BY FORD PERFORMANCE" LEVELING OFF-ROAD SUSPENSION KITS

Page 69 (F-150)

Page 75 (Ranger)

Loaded with the technology and features you'd expect from Fox, taken to the next level with tuning by Ford Performance Engineers contributing to optimized ride both on-road and off-road.

POWER MODULES

Page 79

Power Modules are the complete powertrain solution for any Ford – in both manual and automatic transmission configurations.

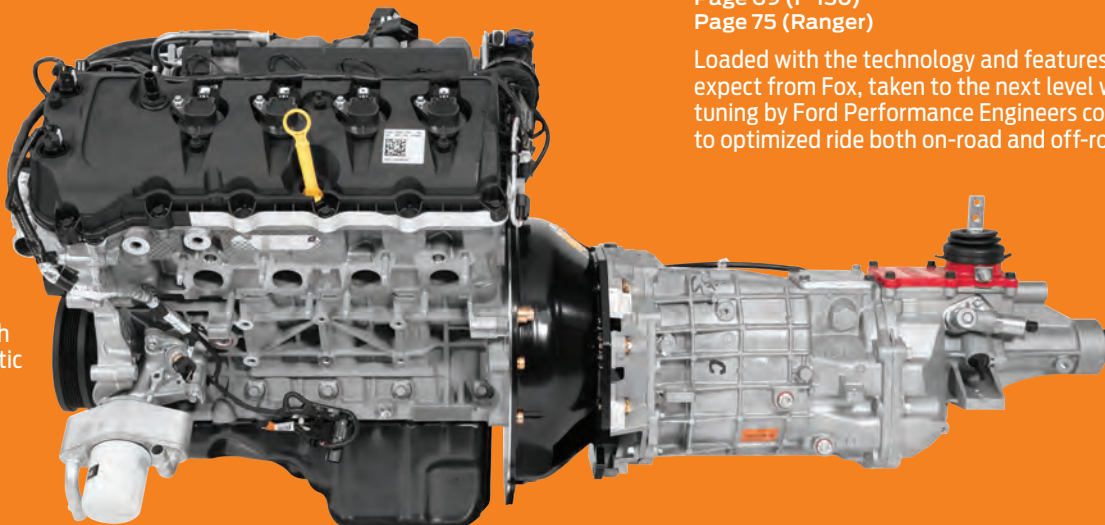

A52XS ENGINE

Page 84

Capable of producing up to 580 horsepower (using premium pump gas), the 5.2L Aluminator XS engine offers a high-performance aftermarket option for Mustang enthusiast in search of enhanced powertrain options.

CHASE RACKS

Page 72 (F-150 & Super Duty®)

Page 75 (Ranger)

These rugged, great looking and functional Chase Racks are easy to install and provide a great base for mounting your accessories.



TABLE OF CONTENTS

FORD CARS	6
2015-2019 Mustang.....	6-33
2014-Earlier Mustang.....	34-55
Focus/Fiesta/Taurus Sho	56-63
FORD TRUCK	64
Super Duty®/F-150 /Raptor/Ranger	64-77
FORD PERFORMANCE ENGINES	78
Coyote Engines And Components	78-104
Modular Engines And Components	105-112
EcoBoost® Engines And Components.....	113-114
Pushrod Engines And Components	116-144
Pushrod Big Block Engines And Components.....	145-150
Pushrod I-4 Engines And Components	151
Nascar® Engine Components.....	152-153
Engine/Block Specifications And Dimensions.....	154-159
Engine Electronics/Fuel Injection	160-167
DRIVELINE COMPONENTS	168
APPEARANCE & DRESS-UP	186
FORD ACCESSORIES & APPAREL	198
FORD DEALER LISTING	214
WARRANTY INFORMATION	217
INDEX AND PRICE LIST	226

PERFORMANCE PARTS DESIGNATIONS

As a leading manufacturer of performance parts, Ford Motor Company recognizes a special responsibility regarding environmental concerns. Ford Performance is committed to a program of performance parts development that allows motorsport enthusiasts to modify their vehicles and meet emission requirements.



Using guidelines established by the State of California for aftermarket parts used in vehicles driven on public highways, this catalog identifies parts that are acceptable for use on emission-controlled motor vehicles using the “50-States Street Legal” logo, shown to the left. Parts without the logo are intended for off-road and competition purposes only.

Parts with the “50-States Street Legal” logo are considered “Street Legal” by Executive Order. These add-on or modified parts are considered “Street Legal” because they have an Executive Order from the State of California. Ford Performance has demonstrated through emission testing that the use of these parts does not adversely affect vehicle emissions of production vehicles with certified emission control systems.

IMPORTANT NOTICE

This catalog primarily lists special performance parts, many of which are designed for off-highway use only. U.S. and Canadian laws and regulations prohibit removal of or tampering with components installed on production vehicles to meet emission requirements or to comply with motor vehicle safety regulations applicable to vehicles manufactured for use on public roads. Customers are advised that vehicles equipped with parts designated for “off-highway use” should not be operated on public roads. Ford offers such parts only for track or off-highway or competitive performance use. Such parts have a special “warning” label (see insert at right). All parts in this catalog without the “50-States Street Legal” logo pictured above are included in this designation.

FUTURE DEVELOPMENTS

While many Ford Performance parts have no application for cars driven on public highways, Ford Performance continues to develop, analyze and test additional engine and powertrain parts with the goal of making them “Street Legal.” Ford’s vision is to provide products meeting all of our various customers’ needs while remaining environmentally responsible.

WARNING: Many of these parts have been designed and are intended for off-highway application only. Installation of these parts on a vehicle that is driven on public roads may violate U.S. and Canadian laws and regulations relating to emission requirements and motor vehicle safety standards. In addition, installation of these parts may adversely affect the warranty coverage on your vehicle.

For more information, call the Ford Performance Techline at (800)367-3788.

Products marked with the “Proudly Made in the USA” icon are made in the U. S. A. with domestic and foreign parts.



NOTE: Horsepower and torque ratings were attained using premium unleaded pump gas.

BULLITT and all related characters and elements © and ™ Warner Bros. Entertainment, Inc. (s17)



We Share Your Enthusiasm

If there's a phrase that aptly sums up Ford Performance, it's this: **"Go like Hell."**

Yes, it is the title of A.J. Baime's book that tells the remarkable late-60's story of how Henry Ford II – with the help of a young visionary named Lee Iacocca and a former racing champion turned engineer, Carroll Shelby – applied Ford's performance capabilities to jumpstart the company.

They designed, built, and raced a car (the GT40) that beat world-renowned Ferrari at its own game – and at the most prestigious and brutal race in the world (Le Mans).

It was something no American car had ever done before.

It was also the catalytic event that reinforced Ford's performance know-how with the street, drag strip and track enthusiasts of that era.

More than 50 years later, technologies for going faster have evolved, but the mind-set(s) haven't; performance enthusiasts simply loathe standing still at sanctioned venues and events.

They always need to "go like hell", be it on the track, drag strip, or exploring a new off-road trail.

Some call it being afflicted with "performance disease".

We call it an elixir for the soul.

Like you, we are vehicle enthusiasts with an affinity for visceral performance. We know it's all about going faster, running longer, winning stronger and creating separation from the competition.

We love to win – always have; that's what competition is all about.

And we especially love it when you win, whether that means winning a race or owning a Ford vehicle that exceeds your aspirations and satisfies your passion for performance.

At Ford Performance, we share your enthusiasm.

In fact, we cater to it.

Here's how.



Performance



Ford has a long history of creating performance variants of its vehicles dating back to the mid-1960's. Today, these cars, utilities and trucks are the life-blood of enthusiast communities around the world who love performance vehicles, and carry an affinity for driving them.

Ford GT

The Ford GT supercar, launched in 2016, remains today's pinnacle product of Ford Performance. It is the culmination of everything great we do, and represents our passion for innovation.

And yes, this generation of the Ford GT won the legendary 24 Hours of Le Mans too – on its first try no less.

Mustang Shelby® GT500®

The latest-generation Shelby GT500, introduced in 2019, is – in the words of its chief program engineer – the result of a “relentless dedication to crafting the extraordinary.”

The numbers tell the story: 760 horsepower; 0-60 mph in mid-3.0 seconds; ¼ mile performance in less than 11 seconds; and transmission shifts capable of less than 100 milliseconds.

It is the pinnacle pony, on the track or the drag strip.

Mustang Shelby® GT350® & GT350R

The Mustang Shelby GT350 is designed to achieve lightning-fast performance.

Every system, component and shape is designed and optimized so that all the parts work in holistic harmony and make driving a Shelby GT350 one of the most exhilarating experiences ever felt in a production Mustang.



F-150 Raptor

When it comes to power, the Raptor sets the standard in its class: a high-output twin-turbo, intercooled DOHC 24-valve, 3.5L EcoBoost® engine with port fuel and direct injection paired with a 10-speed automatic transmission generates a massive 450 horsepower and 510 lb.-ft. of torque.

Trail Control™ and a Terrain Management System™ make it easier than ever to do what we do best: take you off-road.

The Raptor can sail through the desert at high speed, scamper up the side of a mountain, leap over sand dunes, and run a 1,000-mile off-road race – all without modification.

We call it “overlanding made easy”... could a rock-hopping, dune-flogging Ranger be on the way?

Edge ST

The Edge ST – Ford’s first SUV to be tuned by the Ford Performance team – features the most powerful V6 engine available in its class with a specially tuned 2.7-liter twin-turbocharged EcoBoost® engine pumping out 335 horsepower and 380 lb.-ft. of torque.

Explorer ST

Continuing the expansion of the ST brand, the all-new 2020 Explorer ST is the most powerful and fun-to-drive Ford SUV ever. Engineered by the Ford Performance team, Explorer ST uses a specially tuned 3.0-liter EcoBoost® engine projected to achieve 400 horsepower and 415 lb.-ft. of torque. A top speed target for track drivers stands at 143 mph.



Performance Parts

You can “personalize” almost any aspect of your Ford vehicle with parts from Ford Performance – we offer everything from nuts, bolts and gaskets to superchargers, calibration tools, crate engines and turnkey race cars.

Only a major OEM can apply the engineering knowledge and resources that go into making these performance parts. Also, Ford Performance engineers are enthusiasts, gear-heads and racers. They know what it takes to produce a winning combination, and have the experience, skills and assets to do it right.

The result: Products from Ford Performance Parts are OEM and racer engineered, developed and tested, which gives you the performance, reliability and durability that adds up to tremendous value.



Connection to the Performance Community

The performance enthusiast community encompasses people involved with show cars and relating events; vintage vehicles and race cars; street-rods and restorations; off-roading and overlanding; and owner clubs and collectors.

Since your loyalty as a Ford enthusiast is very, very important to us, we have ongoing initiatives to help nurture these communities of performance-minded people, and strengthen our relationships with the Ford enthusiast clubs.

Thanks to all those years of working with enthusiasts at the grassroots level, Ford Performance is able to offer these clubs what they had said they wanted the most – a sustainable connection with the company.



Professional Racing

Our racing heritage spans nearly 120 years and infuses our design, engineering and work ethic.

It’s a global heritage, with success stories going back to the 1930s, when a Ford V8 won the Monte Carlo Rally ... the four consecutive GT40 wins at Le Mans in the 1960s ... the all-conquering DFV Formula 1 engine from the late 1960s to the early 1980s ... the hugely successful European Escort RS rally cars of the same period ... “Big Oly”, the off-road racing Ford Bronco that’s possibly the most famous of its kind in American history ... up to today’s Ford GT success in the world’s most renowned 24-hour endurance races in Le Mans and Daytona.

Add in more than 600 wins in NASCAR, more than 200 wins in NHRA, and decades of Best in The Desert and SCORE-sanctioned off-road competitions, and it all makes Ford the only manufacturer in the world that has had such impact and success in motorsports around the globe.

Above: Ford Chip Ganassi Racing Ford GTs have been victorious in 24-hour events at Daytona (twice) and Le Mans.



FORD MUSTANG

2015-2019



MUSTANG – 2015 - 2019

NEW 2018-2019 MUSTANG GT SUPERCHARGER KIT 700 HP M-6066-M8



- Fits 2018-2019 Mustang GT with manual or automatic transmission
- Produces 700 hp and 610 lb-ft of torque at approximately 12 psi of boost with 91 octane fuel
- Kit comes complete with all hardware
- Exclusive calibration – 50-state emissions legal
- Developed with ROUSH® Performance

Kit includes:

- 2.65L twin vortices supercharger (TVS) assembly. The R2650 supercharger features new TVS technology. The new Twin Vortices Series features new four-lobe rotors and high-flow inlet and outlet ports that greatly enhance thermal efficiency, enabling greater volumetric capacity at higher revolutions per minute (rpm)
- Single 87 mm electronic throttle body
- 47 lb/hr, 6-hole, high-impedance fuel injectors
- Lower intake manifold
- Fuel rails
- Complete air-to-liquid intercooler system includes pump, heat exchanger and reservoir
- Drive belt first sheave FEAD system



NOTE: Powertrain calibrations are developed and supported for U.S. and Canadian vehicles only. Federal and state laws prohibit any person from installing aftermarket add-on or modified parts prior to the sale of a new motor vehicle.

2015-2017 MUSTANG GT SUPERCHARGER KIT 670 HP M-6066-M8627



- Fits 2015-2017 Mustang GT with manual or automatic transmission
- 670 hp at approximately 9 psi of boost with 93 octane fuel
- Kit comes complete with all hardware for install
- Exclusive calibration 50-state emissions legal
- Developed with ROUSH® Performance
- Calibration does not support adaptive cruise

Kit includes:

- 2.3L Twin Vortices Series (TVS) Supercharger Assembly. The R2300 Supercharger features new TVS technology. The new TVS features new four-lobe rotors and high-flow inlet and outlet ports that greatly enhance thermal efficiency, enabling greater volumetric capacity at higher revolutions per minute (rpm)
- Lower intake manifold
- Dual 60 mm electronic throttle body
- Air inlet system
- Fuel rails
- Complete air-to-liquid intercooler system includes pump, heat exchanger and reservoir
- Drive belt: FEAD 6-rib system
- 47 lb/hr, 6-hole, high-impedance fuel injectors
- Ford Performance ProCal tool (requires laptop and internet access) with performance calibration for significantly improved throttle response and performance feel



NOTE: Powertrain calibrations are developed and supported for U.S. and Canadian vehicles only. Federal and state laws prohibit any person from installing aftermarket add-on or modified parts prior to the sale of a new motor vehicle.

WARNING: Cancer www.P65Warnings.ca.gov

MUSTANG - 2015-2019 (CONTINUED)



2015-2017 MUSTANG GT SUPERCHARGER RIGHT HAND DRIVE CLOSE OUT PANEL KIT
M-9066-M8RHD

The Ford Performance Right Hand Drive (RHD) modification kit for the M-6066-M8627 Supercharger Kit allows owners of RHD 2015-2017 Mustang GT with 5.0L V8 engines the ability to infuse their Mustang with up to 670 horsepower. This kit is only needed for RHD 2015-2017 Mustang, and only contains the additional parts needed to install the 670 hp kit on factory built RHD Mustang.



Kit includes:

- RHD close out foam seal
- 27 mm constant tension clamp – black
- 19 mm x 19 mm connector (3/4" x 3/4")
- Battery close out foam seal
- RHD brake aspirator extension
- Grille to fascia fasteners
- 5.6 mm (7/32") bypass hose
- Installation instructions

Applications:

- 2015-2017 Mustang GT 5.0L V8 Coupe RHD models – manual & automatic
- 2015-2017 Mustang GT 5.0L V8 convertible RHD models – manual & automatic



2015-2017 MUSTANG GT PERFORMANCE CALIBRATION POWER PACKS

Fits 2015-2017 Mustang GT

- Features exclusive no-lift shift strategy and enhanced throttle response
- Ford Performance calibrations feature exclusive Ford proprietary software and engineering
- Ford Performance calibrations are 50-state legal with CARB EO (D-598-19)
- Calibrations available for manual and automatic transmission
- Allows gear ratio changes up to 4.09:1
- Automatic calibrations feature optimized performance shift schedule
- Premium fuel, 91 octane or higher, is required

Calibration Notes:

- Ford Performance ProCal tool, included with all calibrations, requires laptop and internet access for calibration install
- At this time power packs are sold separately and cannot be upgraded without the purchase of an entire kit
- Powertrain calibrations are developed and supported for U.S. and Canadian vehicles
- Federal and state laws prohibit any person from installing aftermarket add-on or modified parts prior to the sale of a new motor vehicle
- Calibrations are available with three levels of hardware and performance.

2015-2017 MUSTANG GT PERFORMANCE CALIBRATION POWER PACK 1
M-9603-M8*



- Includes high-flow K&N air filter
- 13 hp and 16 lb-ft peak gains over stock
- 40 lb-ft gain at 1500 rpm
- Laptop required, not included

WARNING: Cancer www.P65Warnings.ca.gov

2015-2017 MUSTANG GT COLD AIR INTAKE AND CALIBRATION POWER PACK 2
M-9603-M8A*



- Includes GT350 cold air intake with 87 mm throttle body and exclusive intake adapter (hardware available separately without calibration as Part No. M-9603-M50)
- 21 hp and 24 lb-ft peak gains over stock
- 40 lb-ft gain at 1500 rpm
- Industry exclusive open air filter with CARB EO
- Laptop required, not included

NOTE: Does not fit properly with Ford Performance M-6766-A50 Oil-Air Separator due to throttle body stack up/alignment.

WARNING: Cancer www.P65Warnings.ca.gov

2015-2017 MUSTANG GT PERFORMANCE INTAKE AND CALIBRATION POWER PACK 3
M-9452-M8*

- Includes GT350 cold air intake with 87 mm throttle body and GT350 Intake Manifold M-9424-M52
- 37 hp and 5 lb-ft peak gains over stock
- 60 hp gain at 7500 rpm
- Industry's only 50-state legal calibration with performance intake manifold
- Laptop required, not included



2016 MUSTANG COBRA JET AIR INLET M-9600-SCJ16

- As used on 2016 Cobra Jet with supercharged engine M-6007-SCJ16
- Includes air inlet tube with molded boot for throttle body attachment and M-9601-D Conical Air Filter
- Can be used with Whipple™ 2.9L 2015-2017 supercharger kits for off-road use
- Approximate 140 mm diameter at MAF sensor location
- MAF sensor sold separately
- Does not include serialized build plaque – plaque is exclusive to turnkey Cobra Jet race cars
- Air filter mounts in fender well



- Calibration is necessary to prevent engine damage!
- Calibration not included!

2015-2017 MUSTANG 2.3L COLD AIR INTAKE (NO CAL) M-9603-M23

- Fits 2015-2017 Mustang with 2.3L engine
- Includes GT350 open element air-box with proprietary inlet housing
- Uses production air hose from inlet to turbocharger, making for a quick and easy installation
- Kit is available with exclusive CARB legal Ford Performance calibration see Part No. M-9603-M4
- Calibration not included!



WARNING: Cancer www.P65Warnings.ca.gov

2015-2017 MUSTANG 2.3L ECOBOOST® PERFORMANCE CALIBRATION KIT M-9603-M4

- M-9603-M23 Cold Air Intake Kit
- ProCal 3 calibration interface
- Calibration voucher
- Laptop required, not included
- Horsepower and torque gains throughout the powerband
- Exclusive Ford Performance warranty when dealer installed
- Ford Performance calibrations are 50-state legal with CARB EO (D-598-18)
- Allows gear ratio changes up to 4.09:1
- Automatic calibrations feature optimized performance shift schedule
- Horsepower and torque gains will not be optimized until fuel octane is learned

Calibration features:

- Peak gains of 25 hp at 5500 rpm and 70 lb-ft torque at 2200 rpm
- 40 hp and 60 lb-ft torque average gain from 2500-5000 rpm
- 75 hp and 64 lb-ft average gain from 5500-6800 rpm
- 100 hp maximum gain at 6000 rpm



WARNING: Cancer www.P65Warnings.ca.gov

*This component is eligible for the Ford Performance Parts Limited Warranty. See the Ford Performance Parts Limited Warranty on pages 217-225 for details.

2015-2017 MUSTANG 5.0L COLD AIR INTAKE AND THROTTLE BODY (NO CAL) M-9603-M50

- Fits 2015-2017 Mustang GT
- Includes GT350 open element air-box w/inlet tube and M-9926-M52 Throttle Body
- Proprietary throttle body adapter allows installation with no changes to Mustang GT intake manifold
- Cold air inlet allows better breathing for increased horsepower
- Throttle body is larger than Mustang GT (87 mm vs. 80 mm)
- Kit is available with exclusive CARB legal Ford Performance calibration, Part No. M-9603-M8A for a gain of 21 peak horsepower
- Includes production GT350 air filter, high-flow K&N replacement filter available as Part No. M-9601-G
- Calibration is necessary to prevent engine damage! Calibration not included!



WARNING: Cancer www.P65Warnings.ca.gov

5.0L/5.2L COYOTE OIL-AIR SEPARATOR RH M-6766-A50

- Fits 2011-2017 5.0L Mustang GT, 2012-2013 5.0L BOSS 302, 2011-2014 5.0L F-150 and 2015-2017 5.2L GT350 engines
- This oil-air separator is a must-have for any track enthusiast!
- Precision molded canister with unique filter media separates oil vapor from the air in the PCV system
- Designed and engineered specifically for installation on the Ford Coyote family engines
- All OEM quality hoses and fittings are used for a high quality installation and function
- Canister is located on the right front (passenger side) of the engine
- This is a highly engineered system, not a universal “fits-all” kit, developed by the experts who know your Coyote engine best
- Canister is easy to drain by removing PCV lines off canister, removing canister and draining oil
- Engineered and manufactured in the USA
- A top seller for Ford Performance Parts
- Does not fit properly with M-9603-M8A due to throttle body stack up/alignment



NEW 2018-2019 MUSTANG ECOBOOST® PERFORMANCE CALIBRATION M-9603-M4C

- Fits 2018-2019 Mustang EcoBoost® with manual or automatic transmissions
- Horsepower and torque gains throughout the powerband
- 35 HP peak gain at 2,900 rpm
- 76 lb.ft. Torque peak gain at 2,600 rpm
- Exclusive Ford Performance warranty when dealer installed
- Ford Performance calibrations are 50 state legal with CARB EO (D-752-2)
- Automatic calibrations feature optimized performance shift schedule
- Powertrain calibrations are developed and supported for U.S. and Canadian vehicles
- Premium (91 octane or higher) fuel only
- Horsepower and torque gains will not be optimized until fuel octane is learned

* Laptop PC not included



Includes:

- Pro Cal 3 calibration interface
- Ford Performance M-9601-M High Flow Performance Air Filter
- Calibration voucher

Call the Ford Performance Techline at (800)367-3788

MUSTANG - 2015-2019 (CONTINUED)
5.2L GT350 OIL-AIR SEPARATOR LH
M-6766-A50S

- Fits 2015-2019 Mustang GT350 5.2L Coyote engine
- This oil-air separator is a must-have for any track enthusiast!
- Precision molded canister with unique filter media separates oil vapor from the air in the PCV system
- Designed and engineered specifically for installation on the GT350 5.2L Coyote engine
- All OEM quality hoses and fittings are used for a high quality installation and function
- Canister is located on the left front (driver side) of the engine
- This is a highly engineered system, not a universal "fits-all" kit, developed by the people who know your engine best
- Canister is easy to drain by removing PCV lines off canister, removing canister and draining oil
- Engineered and manufactured in the USA
- A top seller for Ford Performance Parts

2.3L MUSTANG ECOBOOST® OIL-AIR SEPARATOR
M-6766-A23 Left Hand
M-6766-A23S Right Hand (with integrated PCV sensor)

- Designed specifically for use on 2015-2019 EcoBoost®-equipped Mustang 2.3L engines
- This oil-air separator is a must-have for any track enthusiast!
- Precision molded canister with unique filter media separates oil vapor from the air in the PCV system
- All OEM quality hoses and fittings are used for a high-quality installation and function
- This is a highly engineered system, not a universal "fits-all" kit, developed by the experts who know your EcoBoost® engine best
- Canister is easy to drain by removing PCV lines off canister, removing canister and draining oil

NEW 2020 GT500 5.2L OIL-AIR SEPARATOR
M-6766-A52

This oil-air separator is a must have for any GT500 track enthusiast!

- Fits 2020 Mustang GT500
- Original equipment with the 2020 Mustang GT500 Track Package
- Canister is located on the RH (passenger side of the engine)
- Precision molded canister with unique filter media separates oil vapor from the air in the PCV system
- Designed and engineered by Ford Performance engineers during thousands of track miles specifically for installation on the 2020 GT500
- All OEM quality hoses and fittings are used for a high-quality installation and function
- This is a highly engineered system developed by the experts that know your GT500 engine best
- No emptying required as the separator features an oil drain back into the RH coil cover of the engine
- Will work with 2011-2017 5.0L and 2015-2019 5.2L engines with the addition of M-6067-M52S Aluminum Cam Cover – Pair

2018-2019 5.0L COYOTE OIL-AIR SEPARATOR RH
M-6766-A50A

This oil-air separator is a must have for any track enthusiast!

- Fits 2018-2019 5.0L Mustang GT and 2019 Mustang BULLITT™
- Canister is located on the RH (Passenger) side of the engine
- Precision molded canister with unique filter media separates oil vapor from the air in the PCV system
- Designed and engineered specifically for installation on the Ford Coyote family engines
- All OEM quality hoses and fittings are used for a high quality installation and function
- This is a highly engineered system, not a universal "fits-all" kit, developed by the experts that know your Coyote engine best
- Canister is easy to drain by removing PCV lines off canister, removing canister and draining oil
- Engineered and manufactured in the USA

2015-2019 MUSTANG GT 5.0L PERFORMANCE GT350 RADIATOR
M-8005-M8

- Fits: 2015-2019 Mustang GT 5.0L with manual and automatic transmission
- Fits: 2015-2019 Mustang GT350
- Original equipment on 2015-2019 Mustang GT350 and Mustang GT equipped with the Performance Pack option
- Radiator is less restrictive and provides more volume than standard radiator
- Improved cooling over stock non-Performance Pack Mustang radiator

2015-2017 MUSTANG FORD PERFORMANCE RADIATOR COVER
M-8291-FP

- Fits 2015-2017 Mustang except GT350
- As used on 2016 Cobra Jet
- OEM radiator cover with "FORD PERFORMANCE" machined into surface
- Due to material properties some machine marks in logo may be present

2015-2019 MUSTANG SHELBY GT350 AIR FILTER M-9601-G



- Fits 2015-2019 Shelby GT350
- Also fits 2010-2014 Mustang Shelby GT500 5.4 and 5.8L supercharged engines
- AIRAID® premium filter is hand-built using the finest materials available today
- Filter element is blue
- This high-flow filter uses multiple cotton gauze layer construction that's washable and reusable
- Delivers significant improvements in airflow while providing outstanding filtration
- The oil-free maintenance makes them one of the easiest filters to service on the market
- Servicing these filters is simple – just wash with a mild household detergent, rinse, allow to dry and reinstall

WARNING: Cancer www.P65Warnings.ca.gov

2015-2019 MUSTANG GT, I4 AND V6 HIGH-FLOW K&N/ FORD PERFORMANCE AIR FILTER M-9601-M



- K&N 4-ply panel washable air filter
- Fits stock 2015-2019 Mustang GT, I4 and V6 air-box
- For GT350 see Part No. M-9601-G
- Flows approximately 22% more than stock filter at 1.5" H2O delta pressure
- Does not require PCM recalibration

WARNING: Cancer www.P65Warnings.ca.gov

2015-2017 MUSTANG GT 5.0L CAT BACK ACTIVE EXHAUST SYSTEM KIT WITH GT350 EXHAUST TIPS & LOWER VALANCE M-5200-M8*



- Fits 2015-2017 Mustang GT 5.0L Coupe and Convertible with premium rear bumper
- Uniquely designed and tuned to provide optimum performance, aggressive sound, durability and pure driving excitement
- Adds GT350 active exhaust functionality with two 2.5" NPP valves to be able to change the exhaust sound
- Features 2.5" ultra-smooth mandrel bends, warp-free flanges and superior craftsmanship
- Manufactured in the USA from high-quality 304 stainless steel
- Bolts to stock catalytic converters
- Integral X-pipe

System includes:

- Rear lower GT350 valance with quad exhaust tips
- Control module and all needed wiring
- Detailed installation instructions



*This component is eligible for the Ford Performance Parts Limited Warranty. See the Ford Performance Parts Limited Warranty on pages 217-225 for details.

2015-2019 MUSTANG GT350 ACTIVE CAT BACK SPORT EXHAUST SYSTEM M-5200-MSS*



This cat-back active exhaust system with integral X-pipe bolts directly to the stock factory catalytic converters, making your Mustang 100% emission compliant while providing an aggressive muscle car sound. The tuned stainless steel mufflers retain the factory active exhaust functionality and not only sound great but look great too.

- Fits 2015-2019 Mustang GT350 5.2L
- Uniquely designed and tuned to provide optimum performance, aggressive sound, durability and pure driving excitement
- Manufactured in the USA from high-quality 304 stainless steel
- Features ultra-smooth mandrel bends, warp-free flanges and superior craftsmanship
- Integral X-pipe with 2.5" stainless steel mandrel bent cat-back tubing
- Bolts to stock catalytic converters
- Maintains factory active exhaust functionality
- Uses stock hangers and mounts



2015-2017 MUSTANG GT 5.0L CAT BACK SPORT EXHAUST SYSTEM



M-5200-M8SB* Black Chrome Tips
M-5200-M8SC * Chrome Tips

- Fits 2015-2017 Mustang GT 5.0L Coupe and Convertible
- Uniquely designed and tuned to provide optimum performance, aggressive sound, durability and pure driving excitement
- Manufactured in the USA from high-quality 304 stainless steel
- Features ultra-smooth mandrel bends, warp-free flanges and superior craftsmanship
- Integral X-pipe with 2.5" stainless steel mandrel bent cat-back tubing
- Bolts to stock catalytic converters
- Approximately 30 lbs lighter than the factory cat-back system
- Uses stock hangers and mounts



M-5200-M8SC SHOWN

Call the Ford Performance Techline at (800)367-3788

MUSTANG - 2015-2019 (CONTINUED)
2015-2017 MUSTANG GT 5.0L CAT-BACK TOURING EXHAUST SYSTEM

M-5200-M8TB* Black Chrome Tips
M-5200-M8TC* Chrome Tips

- Fits 2015-2017 Mustang GT 5.0L Coupe and Convertible
- Uniquely designed and tuned to provide optimum performance, aggressive sound, durability and pure driving excitement
- Meets 95 decibel drive-by noise standard for aftermarket exhaust systems when installed on stock applications
- Manufactured in the USA from high-quality 304 stainless steel
- Features ultra-smooth mandrel bends, warp-free flanges and superior craftsmanship
- Integral X-pipe with 2.5" stainless steel mandrel bent cat-back tubing
- Bolts to stock catalytic converters
- Approximately 30 lbs lighter than the factory cat-back system
- Uses stock hangers and mounts



M-5200-M8TC shown

2015-2017 MUSTANG GT 5.0L CAT-BACK SPORT EXHAUST SYSTEM WITH GT350 EXHAUST TIPS AND LOWER VALANCE

M-5200-M8SBV*

- Fits 2015-2017 Mustang GT 5.0L Coupe and Convertible with premium rear bumper
- Uniquely designed and tuned to provide optimum performance, aggressive sound, durability and pure driving excitement
- Manufactured in the USA from high-quality 304 stainless steel
- Features ultra-smooth mandrel bends, warp-free flanges and superior craftsmanship
- Integral X-pipe with 2.5" stainless steel cat-back tubing
- Bolts to stock catalytic converters
- Approximately 30 lbs lighter than the factory cat-back system
- GT350 quad exhaust tips
- Uses stock hangers and mounts
- Includes rear lower GT350 valance

2015-2017 MUSTANG 5.0L CAT-BACK TOURING EXHAUST SYSTEM WITH GT350 TIPS AND LOWER VALANCE

M-5200-M8TBV*

- Fits 2015-2017 Mustang GT 5.0L Coupe and Convertible with premium rear bumper
- Uniquely designed and tuned to provide optimum performance, aggressive sound, durability and pure driving excitement
- Meets 95 decibel drive-by noise standard for aftermarket exhaust systems when installed on stock applications
- Manufactured in the USA from high-quality 304 stainless steel
- Features ultra-smooth mandrel bends, warp-free flanges and superior craftsmanship
- Integral X-pipe with 2.25" stainless steel cat-back tubing
- Bolts to stock catalytic converters
- Approximately 30 lbs lighter than the factory cat-back system
- GT350 quad exhaust tips
- Uses stock hangers and mounts, includes rear lower GT350 valance

2015-2017 MUSTANG GT 5.0L SPORT MUFFLER KIT WITH GT350 EXHAUST TIPS AND LOWER VALANCE

M-5230-M8SBV*

- Fits 2015-2017 Mustang GT 5.0L Coupe and Convertible with premium rear bumper
- Uniquely designed and tuned to provide optimum performance, aggressive sound, durability and pure driving excitement
- Made from high-quality 304 stainless steel
- Features ultra-smooth mandrel bends, warp-free flanges and superior craftsmanship
- 2.5" stainless steel mandrel bent tubing
- Uses stock hangers and mounts
- GT350 quad exhaust tips
- Includes rear lower GT350 valance



2015-2017 MUSTANG GT 5.0L TOURING MUFFLER KIT WITH GT350 EXHAUST TIPS AND LOWER VALANCE

M-5230-M8TBV*



- Fits 2015-2017 Mustang GT 5.0L Coupe and Convertible with premium rear bumper
- Uniquely designed and tuned to provide optimum performance, aggressive sound, durability and pure driving excitement
- Meets 95 decibel drive-by noise standard for aftermarket exhaust systems when installed on stock applications
- Made from high-quality 304 stainless steel
- Features ultra-smooth mandrel bends, warp-free flanges and superior craftsmanship
- 2.5" stainless steel mandrel bent tubing
- Uses stock hangers and mounts
- GT350 quad exhaust tips
- Includes rear lower GT350 valance



2015-2019 MUSTANG GT 5.0L SIDE EXIT EXHAUST SYSTEM

M-5220-M8*



- Fits 2015-2019 Mustang GT 5.0L Coupe
- Production-quality quad exhaust styled from the 2012-2013 Mustang BOSS 302

Kit includes: Left- and right-side exhaust pipes with polished 304 stainless steel tips, 409 stainless steel X-pipe and mounting hardware

- Converts your factory H-pipe to a more efficient X-pipe
- Cutting of factory exhaust required for installation
- Clamp-on installation – does not require welding!
- Installs using existing front factory clamps and supplied rear clamps



2015-2017 MUSTANG GT 5.0L TOURING MUFFLER KIT – CHROME TIPS



- M-5230-M8TC* Chrome Tips
- M-5230-M8SC* Black Chrome Tips

- Fits 2015-2017 Mustang GT 5.0 Coupe and Convertible
- 2.5" stainless steel mandrel bent tubing
- Aggressive sound is 50-state drive-by noise legal
- Factory exhaust pipe must be cut to install clamp on Ford Performance axle-back mufflers
- Uses stock hangers and mounts



2015-2019 MUSTANG GT X-PIPE

M-5251-M8*



- Fits 2015-2019 Mustang GT 5.0L Coupe and Convertible
- 409 stainless steel X-pipe
- Converts your factory H-pipe to a more efficient X-pipe
- Cutting of factory exhaust required for installation
- Clamp-on installation – does not require welding! Installs using existing front factory clamps and supplied rear clamps



*This component is eligible for the Ford Performance Parts Limited Warranty. See the Ford Performance Parts Limited Warranty on pages 217-225 for details.

MUSTANG - 2015-2019 (CONTINUED)



MUSTANG CAT-BACK AND AXLE-BACK EXHAUST SYSTEMS

Refer to charts for part numbers and tip style availability

Ford Performance by Borla® cat-back and axle-back exhaust systems are manufactured in the USA using high-quality mandrel-bent 304 stainless steel tubing. These systems offer easy installation and are available in three sound levels with options for chrome, black chrome or carbon fiber tips.

- Full cat-back and axle-back systems available for 2018-2019 Mustang GT and 2015-2019 EcoBoost® Mustang coupe and convertible models
- Uniquely designed and tuned to provide optimum performance, aggressive sound, durability and pure driving excitement!

5.0L MUSTANG GT CAT-BACK AND AXLE-BACK EXHAUST SYSTEMS*

Full cat-back and axle-back systems available for 2018-2019 5.0L Mustang GT coupe and convertible models.

Cat-Back Features:

- Bolts to stock catalytic converters
- 2.5" stainless steel tubing features a high-flow forward muffler on Touring models and an Integral X-Pipe on Sport and Extreme models
- Approximately 30 lbs. lighter than the factory cat-back system
- Uses stock hangers and mounts

Axle-Back Features:

- 2.5" stainless steel tubing
- 4" plated stainless-steel or carbon fiber tips
- Uses stock hangers and mounts
- Factory exhaust pipe must be cut to install clamp on Ford Performance axle-back mufflers



M-5200-M8TBA

2.3L ECOBOOST® MUSTANG CAT-BACK AND AXLE-BACK EXHAUST SYSTEMS*

Full cat-back and axle-back systems available for 2015-2019 EcoBoost® Mustang coupe and convertible models.

Cat-Back Features:

- Bolts to stock catalytic converters
- Feature an integral Y-pipe with 2.25" stainless steel tubing
- Approximately 20 lbs. lighter than the factory cat-back system
- Uses stock hangers and mounts

Axle-Back Features:

- 2.25" stainless steel tubing
- 4" plated stainless-steel or carbon fiber tips
- Uses stock hangers and mounts
- Factory exhaust pipe must be cut to install clamp on Ford Performance axle-back mufflers

Please see our website (performanceparts.ford.com) for additional information on these exhaust systems and systems for other model years and applications.



M-5230-M8SBA



M-5230-M8SCA



M-5200-M8SBA

2018-2019 MUSTANG 5.0L GT CAT-BACK EXHAUST SYSTEMS

	Touring	Sport	Extreme
Chrome Tips	M-5200-M8TCA	M-5200-M8SCA	M-5200-M8ECA
Black Chrome Tips	M-5200-M8TBA	M-5200-M8SBA	M-5200-M8EBA
Carbon Fiber Tips	M-5200-M8TFA	M-5200-M8SFA	M-5200-M8EFA

2018-2019 MUSTANG 5.0L GT AXLE-BACK EXHAUST SYSTEMS

Chrome Tips	M-5230-M8TCA	M-5230-M8SCA	M-5230-M8ECA
Black Chrome Tips	M-5230-M8TBA	M-5230-M8SBA	M-5230-M8EBA
Carbon Fiber Tips	M-5230-M8TFA	M-5230-M8SFA	M-5230-M8EFA

2015-2019 MUSTANG 2.3L ECOBOOST® CAT-BACK EXHAUST SYSTEMS

	Touring	Sport	Extreme
Chrome Tips	M-5200-M4TCA	M-5200-M4SCA	M-5200-M4ECA
Black Chrome Tips	M-5200-M4TBA	M-5200-M4SBA	M-5200-M4EBA
Carbon Fiber Tips	M-5200-M4TFA	M-5200-M4SFA	M-5200-M4EFA

2015-2019 MUSTANG 2.3L ECOBOOST® AXLE-BACK EXHAUST SYSTEMS

Chrome Tips	M-5230-M4TCA	M-5230-M4SCA	M-5230-M4ECA
Black Chrome Tips	M-5230-M4TBA	M-5230-M4SBA	M-5230-M4EBA
Carbon Fiber Tips	M-5230-M4TFA	M-5230-M4SFA	M-5230-M4EFA

SOUND LEVEL OPTIONS:

TOURING – Deeper tone than stock. Meets 95 decibel drive-by noise standard for aftermarket exhaust systems when installed in stock applications

SPORT – Deeper tone with increased volume over stock, louder than Touring

EXTREME – Our most aggressive exhaust sound yet!

5.0L MUSTANG GT TIP STYLES AVAILABLE:

- Quad 4" double-wall chrome plated stainless steel
- Quad 4" double-wall black chrome plated stainless steel
- Quad 4" carbon fiber tips

2.3L ECOBOOST® TIP STYLES AVAILABLE:

- 4" double-wall chrome plated stainless steel
- 4" double-wall black chrome plated stainless steel
- 4" carbon fiber tips

NOTE: Mustang cat-back and axle-back exhaust systems are not intended for use on vehicles equipped with optional factory Active Valve performance exhaust.

*All components listed on this page are eligible for the Ford Performance Parts Limited Warranty. See pages 220-221 for details.

For important information about the proper usage of performance parts, please see page 2. See pages 217-225 for important safety, emissions and warranty information.

2015-2017 MUSTANG 2.3L ECOBOOST® TOURING MUFFLER KIT – CHROME TIPS



- Fits 2015-2017 Mustang 2.3L EcoBoost® Coupe and Convertible
- Uniquely designed and tuned to provide optimum performance, aggressive sound, durability and pure driving excitement
- Meets 95 decibel drive-by noise standard for aftermarket exhaust systems when installed on stock applications
- Made from high-quality 304 stainless steel
- Features ultra-smooth mandrel bends, warp-free flanges and superior craftsmanship
- 2.25" stainless steel mandrel bent tubing
- Uses stock hangers and mounts
- Factory exhaust pipe must be cut to install clamp on Ford Performance axle-back mufflers



2015-2017 MUSTANG 2.3L CAT BACK SPORT EXHAUST SYSTEM WITH GT350 EXHAUST TIPS AND LOWER VALANCE



- Fits 2015-2017 Mustang 2.3L EcoBoost® Coupe and Convertible with premium rear bumper
- Uniquely designed and tuned to provide optimum performance, aggressive sound, durability and pure driving excitement
- Manufactured in the USA from high-quality 304 stainless steel
- Features ultra-smooth mandrel bends, warp-free flanges and superior craftsmanship
- Integral Y-pipe with 2.25" stainless steel cat-back tubing
- Bolts to stock catalytic converter
- GT350 quad exhaust tips
- Uses stock hangers and mounts
- Includes rear lower GT350 valance



2015-2017 MUSTANG 2.3L CAT BACK TOURING EXHAUST SYSTEM WITH GT350 EXHAUST TIPS AND LOWER VALANCE



- Fits 2015-2017 Mustang 2.3L EcoBoost® Coupe and Convertible with premium rear bumper
- Uniquely designed and tuned to provide optimum performance, aggressive sound, durability and pure driving excitement
- Meets 95 decibel drive-by noise standard for aftermarket exhaust systems when installed on stock applications
- Manufactured in the USA from high-quality 304 stainless steel
- Features ultra-smooth mandrel bends, warp-free flanges and superior craftsmanship
- Integral Y-pipe with 2.25" stainless steel cat-back tubing
- Bolts to stock catalytic converter
- Approximately 20 lbs lighter than the factory cat-back system
- GT350 quad exhaust tips
- Uses stock hangers and mounts
- Includes rear lower GT350 valance



2015-2017 MUSTANG 2.3L ECOBOOST® SPORT MUFFLER KIT WITH GT350 EXHAUST TIPS AND LOWER VALANCE



- Fits 2015-2017 Mustang 2.3L EcoBoost® Coupe and Convertible with premium rear bumper
- Uniquely designed and tuned to provide optimum performance, aggressive sound, durability and pure driving excitement
- Manufactured in the USA from high-quality 304 stainless steel
- Features ultra-smooth mandrel bends, warp-free flanges and superior craftsmanship
- 2.25" stainless steel tubing
- GT350 quad exhaust tips
- Uses stock hangers and mounts
- Includes rear lower GT350 valance



*This component is eligible for the Ford Performance Parts Limited Warranty. See the Ford Performance Parts Limited Warranty on pages 217-225 for details.

MUSTANG - 2015-2019 (CONTINUED)

2015-2017 MUSTANG 2.3L ECOBOOST TOURING MUFFLER KIT WITH GT350 EXHAUST TIPS AND LOWER VALANCE
M-5230-M4TBV



- Fits 2015-2017 Mustang 2.3L EcoBoost® Coupe and Convertible with premium rear bumper
- Uniquely designed and tuned to provide optimum performance, aggressive sound, durability and pure driving excitement
- Meets 95 decibel drive-by noise standard for aftermarket exhaust systems when installed on stock applications
- Manufactured in the USA from high-quality 304 stainless steel
- Features ultra-smooth mandrel bends, warp-free flanges and superior craftsmanship
- 2.25" stainless steel tubing
- GT350 quad exhaust tips
- Uses stock hangers and mounts
- Includes rear lower GT350 valance

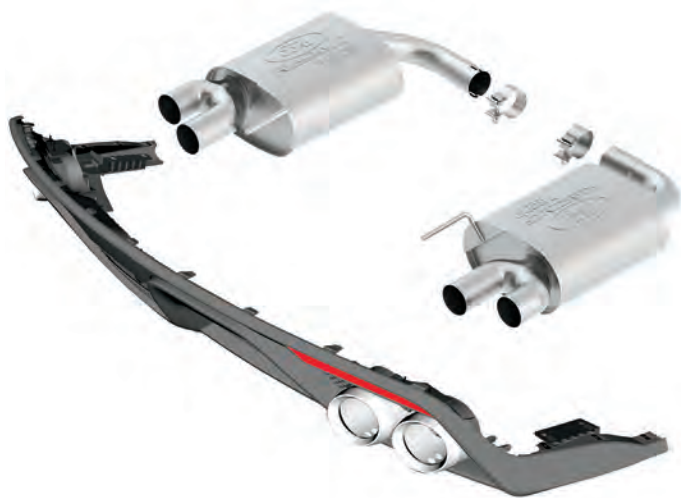

NEW 2015-2019 FORD PERFORMANCE BY BORLA GT FORWARD RESONATOR/MUFFLER
M-5231-M8



- Fits 2015-2019 Mustang GT equipped with a Ford Performance by Borla Cat-Back Exhaust System
- Direct replacement forward resonator as used on Ford Performance Mustang GT "Touring" systems



- Can be used in place of X-Pipe originally provided on Ford Performance by Borla "Sport" or "Extreme" systems to lower (quiet) the sound level
- Manufactured in the USA from high quality 304 stainless steel
- Features 2.5" dual straight flow-through design
- Bolts to stock catalytic converters

2015-2019 MUSTANG GT350 SHIFTER KIT – WITHOUT KNOB
M-7210-M8A*

- Approximately 16% reduction in throw
- Increased driver feel and feedback
- Slight increase in NVH over production shifter
- Kit includes all necessary hardware and instructions to install in 2015-2019 Mustang GT350
- Retains stock M10 x 1.25 thread for shift knob
- Requires some assembly
- DOES NOT include shift knob. Use stock shift knob or optional Ford Performance knobs. See performanceparts.ford.com for details



Kit includes:

- Reduced throw shifter lever
- Reverse lockout sleeve
- Shift knob jam nut
- Thread locking compound
- Grease
- Installation instructions

2015-2019 MUSTANG SHIFTER KIT – WITHOUT KNOB
M-7210-MA*

- Approximately 19% reduction in throw
- Increased driver feel and feedback
- Kit includes all necessary hardware and instructions to install in 2015-2019 Mustang with manual transmission (GT, 2.3L, 3.7L)
- DOES NOT include shift knob. Use stock shift knob or optional Ford Performance knob. See performanceparts.ford.com for details
- Retains stock M12 x 1.25 thread for shift knob
- Requires some assembly



Kit includes:

- Reduced throw shifter lever with pin
- Reverse lockout sleeve
- Increased durometer bushing kit
- Shifter body gasket
- Shift knob jam nut
- Thread locking compound
- Grease
- Installation instructions

⚠ WARNING: Cancer www.P65Warnings.ca.gov

2015-2019 MUSTANG SHORT THROW SHIFTER KIT
M-7210-M8C*

- Approximately 19% reduction in throw
- Increased driver feel and feedback
- Kit includes all necessary hardware and instructions to install in 2015-2019 Mustang with manual transmission (GT, 2.3L, 3.7L)
- Comes with exclusive Ford Performance 6-speed shift knob
- Requires some assembly
- Retains stock M12 x 1.25 thread for shift knob



Kit includes:

- Reduced throw shifter lever with pin
- Reverse lockout sleeve
- M-7213-M8A "Ford Performance" Shift Knob 6-Speed
- Increased durometer bushing kit
- Shifter body gasket
- Shift knob jam nut
- Thread locking compound
- Grease
- Installation instructions

⚠ WARNING: Cancer www.P65Warnings.ca.gov

FORD RACING SHIFT KNOB 6-SPEED M-7213-M8



- Fits stock 2015-2019 Mustang shifter, M-7210-M8 and M-7210-MA Ford Racing short throw shifters
- Included in M-7210-M8 Shifter Kit
- 6-speed black shift knob with "Ford Racing" logo
- Retains stock M12 x 1.25 thread for shift knob



FORD PERFORMANCE SHIFT KNOB 6-SPEED M-7213-M8A

- Fits stock 2015-2019 Mustang shifter, M-7210-M8 and M-7210-MA Ford Racing short throw shifters
- Included in M-7210-M8 Shifter Kit
- 6-speed black shift knob with "Ford Performance" logo
- Retains stock M12 x 1.25 thread for shift knob



FORD PERFORMANCE GT350 SHIFT KNOB 6-SPEED

M-7213-M8SB BLACK
M-7213-M8SR RED
M-7213-M8SW WHITE

- Fits stock 2015-2019 Mustang GT350 shifter and M-7210-M8A Ford Performance Short Throw Shifter
- 2" diameter knob for enhanced feel
- 6-speed shift knob with recessed "GT350" logo
- Gloss finish
- Retains stock GT350 M10 x 1.25 thread for shift knob



M-7213-M8SR shown

2015-2019 MUSTANG CARBON FIBER SHIFT KNOB M-7213-MCF

- Fits stock 2015-2019 Mustang shifter, M-7210-M8 and M-7210-MA Ford Performance short throw shifters
- 6-speed carbon fiber shift knob with genuine carbon fiber weave
- Retains stock M12 x 1.25 thread for shift knob
- Easy do-it-yourself installation



*This component is eligible for the Ford Performance Parts Limited Warranty. See the Ford Performance Parts Limited Warranty on pages 217-225 for details.

NEW MUSTANG BULLITT™ WHITE SHIFT KNOB M-7213-M8B



- Fits 2015-2019 Mustang EcoBoost® and GT models with the 6-speed manual transmission
- Classic white shift knob as used on the Mustang BULLITT™
- Retains stock M12 x 1.25 thread for shift knob



2015-2019 MUSTANG HIGH PERFORMANCE CLUTCH FLUID LINE UPGRADE M-7512-B

- Fits 2015-2019 Mustang GT with manual transmission
- Upgraded clutch fluid line for high temperature, high performance applications
- Strongly recommended for vehicles equipped with headers!
- Replaces factory plastic line
- Stainless steel hard line with braided stainless steel flex hose reduces line expansion
- Includes No. 10 O-rings



2015-2019 MUSTANG FRONT WHEEL HUB KIT WITH ARP STUDS M-1104-AB

- Fits 2015-2019 Mustang GT, 2.3L EcoBoost® and V6
- Front hubs equipped with ARP® wheel studs
- Does not fit vehicles with MagneRide®

Kit includes:

- One pair of upgraded front hubs with 3" ARP® studs
- M-1012-N Open End Wheel Lug Nuts
- Hub retaining nuts
- Hub retaining nut covers
- 3" ARP® stud specifications:
- Wheel stud style: Press-in
- Thread size: M14 x 1.5 RH in.
- Knurl diameter: 0.625"
- Under head length: 3.4"



2015-2019 MUSTANG REAR WHEEL HUB KIT w/ARP STUDS M-1104-B

- Fits 2015-2019 Mustang GT, 2.3L EcoBoost® and V6
- Rear hubs equipped with ARP® wheel studs
- Does not fit Mustang GT350R models

Kit includes:

- One pair of upgraded rear hubs with 3" ARP® wheel studs
- Hub attachment bolts
- Open end wheel lug nuts M-1012-N
- Axle retaining nuts
- 3" ARP® stud specifications:
- Wheel stud style: Press-in
- Thread size: M14 x 1.5 RH in.
- Knurl diameter: 0.625"
- Under head length: 3.4"



MUSTANG - 2015-2019 (CONTINUED)
2015-2019 MUSTANG EXTENDED ARP WHEEL STUD KIT M-1107-C

- Service replacement for Ford Performance M-1104-AB and M-1104-B front and rear wheel hub kits, with extended ARP® studs
- Sold as 1 package of 10 studs
- Requires M-1012-N Open End Lug Nuts or equivalent
- 3" ARP® stud specifications:
- Wheel stud style: Press-in
- Thread size: M14 x 1.5 RH in.
- Does not fit Shelby GT350R



- Knurl diameter: 0.625"
- Under head length: 3.4"

2015-2019 MUSTANG AUTOMATIC IRS PINION FLANGE M-4851-M8A

Original equipment on 2015-2019 Mustang GT Super 8.8" IRS with automatic transmission.

For use on M-4001-88373T and M-4001-88355, which come equipped with manual transmission pinion flange.



WARNING: Cancer www.P65Warnings.ca.gov

2015-2019 SUPER 8.8" IRS RING AND PINION INSTALLATION KIT M-4210-B3

Kit includes:

- OEM pinion bearings and races
- OEM differential bearings and races
- Pinion and differential shims
- Crush sleeve
- Pinion nut
- Pinion seal
- Ring gear bolts
- Gear-marking compound
- Fits all Super 8.8" IRS axles in 2015-2019 Mustang



NOTE: Does not fit earlier 1986-2014 8.8" axles.

WARNING: Cancer www.P65Warnings.ca.gov

2015-2019 MUSTANG IRS KNUCKLE KIT WITH TOE BEARING M-5970-M

- 2015-2019 Mustang IRS knuckles and hubs
- Limits down time for FR3 suspension kit install. M-5A460-M Toe Link Bearing Kit has been pressed in for easy bolt-in installation in the chassis
- Can be used in kit car custom builds
- For kit car or custom vehicle construction, M-2300-MR Rear Brake Kit is recommended

2015-2019 MUSTANG PERFORMANCE PACK REAR TOE LINK KIT

M-5972-M

- Fits 2015-2019 Mustang
- Original equipment on Performance Pack equipped Mustang
- Delrin®-lined spherical bearings prevent deflection compared to base toe link
- Toe links are included in the M-FR3A-M8A and M-FR3A-MAA handling packs
- Kit includes two rear toe links and two toe link cam bolts



WARNING: Cancer www.P65Warnings.ca.gov

2015-2019 MUSTANG KNUCKLE TO TOE LINK BEARING ASSEMBLY

M-5A460-M

- Fits 2015-2019 Mustang GT and 2.3L EcoBoost®
- Integral component of the M-FR3A-M8A Track Handling Pack
- Replaces the rubber toe link bushing in the rear knuckle with a Delrin®-lined spherical bearing
- Removes suspension compliance with minimal impact to ride quality
- Improves handling, especially in power down situations
- Includes 2 bearings

GT350 DIFFERENTIAL COOLER KIT

M-4000-M8S

- Fits 2015-2016 Mustang Shelby GT350 only
- Kit includes components from the production GT350 Track/R model rear differential cooler system and a unique stand-alone wiring harness with mechanical and thermal switches
- Complete wiring harness with switching, relay and fuse included
- Differential cooler
- Cooler pump
- Cooler lines
- Mounting hardware
- Differential cover
- Detailed instructions



MUSTANG GT350 TRANSMISSION WITH PUMP M-7000-M8S

- Original equipment on 2015-2016 Mustang GT350 equipped with Track Package and GT350R; 2017 and newer Mustang GT350
- Transmission includes internal pump for transmission cooler kit

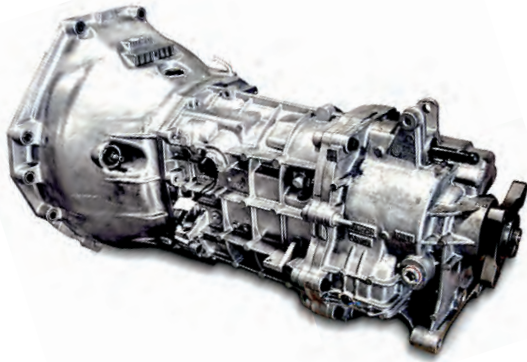

2015-2019 MUSTANG SUPER 8.8" IRS LOADED DIFFERENTIAL HOUSING 3.55 M-4001-88355B



Loaded differential housing for Mustang IRS.

- Fits 2018-2019 Mustang
- Fits 2015-2017 Mustang (see technical notes below)
- Iron housing with aluminum cover
- Includes 3.55:1 ratio gear set M-4209-88355A and Traction-Lok differential M-4204-M
- Custom calibration required for speedometer and shift corrections
- Original Equipment on 2019 Mustang GT



NOTE on 2015-2017 Mustang, pinion flange change may be necessary; comes with pinion flange with 93mm bolt circle and 110mm driveshaft pilot installed. For applications that require 95mm bolt circle and 113mm driveshaft pilot, use FR3Z-4851-B pinion flange, available through Ford dealer.

WARNING: Cancer www.P65Warnings.ca.gov

2015-2019 MUSTANG SUPER 8.8-INCH TRACTION-LOK DIFFERENTIAL M-4204-M



- Fits 2015-2019 Mustang GT, V6 and I4 with 3.31, 3.55, 3.73 and 4.09 ratio gears only
- Traction-Lok 8.8" differential
- Fits 34-spline axles
- Requires 4 oz of CM-19546-A1 Friction Modifier with initial fill
- For use with M-4209-88355A and M-4209-88373A Super 8.8" gear sets
- Use M-4210-B3 Differential Install Kit



2015-2019 MUSTANG GT SUPER 8.8 TORSEN DIFFERENTIAL M-4204-MT



- Fits 2015-2019 Mustang GT, V6 and I4 with 3.31, 3.55, 3.73 and 4.09 ratio gears only
- Standard on 2015-2016 Mustang GT performance pack
- Fits 34-spline axles
- Torsen® T-2R-type differential
- Features full-time torque sensing, torque biasing



WARNING: Cancer www.P65Warnings.ca.gov

SUPER 8.8 RING GEAR BOLT KIT (10 PIECES) M-4216-C



- Fits 2015-2019 Mustang IRS
- M12 x 1.25 x 26 mm
- Grade 10.9
- One-time-use bolts
- Set of 10 bolts
- Recommended for use with Super 8.8" M-4209-88373A and M-4209-88355A ring and pinion sets



WARNING: Cancer www.P65Warnings.ca.gov

MUSTANG SUPER 8.8 IRS BEARING & SEAL KIT M-4413-B



- Fits 2015-2019 Mustang Super 8.8" IRS axle

Kit includes:

- Two inner stub shaft bearings
- Two inner stub shaft bearing housing seals
- Recommended for use with M-4210-B3 Gear Install Kit



WARNING: Cancer www.P65Warnings.ca.gov

2015-2019 MUSTANG TRACK STRUT AND SHOCK KIT

- M-18000-F Complete Kit
- M-18001-AG Single Front Service Strut
- M-18001-AS Single Rear Service Strut

- Fits 2015-2019 Mustang GT and 2.3L EcoBoost® Coupes
- Designed specifically as part of the M-FR3A-M8A Track Handling Pack
- Designed for use with M-5300-Y Track Lowering Springs
- Track tuned by Ford Performance engineers

Kit includes:

- M-FR3A-M8A Track Front Dampers
- M-FR3A-M8A Track Rear Shocks
- Front strut top mounts
- Front strut spring retainer
- Front damper anti-squeak pads
- Strut rod nuts
- Threadlock

NOTE: When using Ford Performance M-5300-Y Track Lowering Springs or any other aftermarket lowering springs, it is recommended to use Ford Performance Mustang M-5570-B Jounce Bumper Kit.

NOTE: Please reference a Ford service manual for installation information and correct torque specifications. May require alignment after installation.



WARNING: Cancer www.P65Warnings.ca.gov

M-18000-F
Complete Kit shown

MUSTANG - 2015-2019 (CONTINUED)
2015-2019 MUSTANG FRONT STRUT MOUNT (PAIR)
M-18183-M

- Original equipment on 2016-2019 Mustang
- Original equipment on 2015 Mustang GT equipped with the Performance Pack
- Increased bushing durometer compared to base 2015 Mustang
- Used in assembled FR3 handling kits M-FR3A-M8A & M-FR3A-MAA
- Perfect for DIY strut assembly replacement

2015-2018 MUSTANG GT350 HALF SHAFT KIT
M-4130-M8S

- Fits 2015-2018 Mustang GT, 2.3L EcoBoost® and V6
- Original equipment on 2015-2017 Mustang GT350
- Increased diameter left side half shaft vs. Mustang GT
- Value priced upgrade for mild drivetrain modifications and naturally aspirated engines
- Kit includes both right and left half shafts



⚠ WARNING: Cancer www.P65Warnings.ca.gov

2015-2018 MUSTANG HALF SHAFT UPGRADE KIT

M-4130-MA Half Shaft Kit
M-4138-MA Half Shaft Assembly (Right Side)
M-4139-MA Half Shaft Assembly (Left Side)

- Fits all 2015-2018 Mustang – GT, V6, I4 and GT350
- Fits in place of production half shafts with no other vehicle modifications
- Severe duty serviceable CV joints with CNC billet centers support up to 1500 hp
- CNC-machined from aerospace high-alloy materials
- Billet one-piece 34-spline inner and 32-spline outer stub ends
- Axle shafts feature anti-wheel-hop technology
- Shafts feature blue powder coating for corrosion resistance
- Built by G-Force Engineering, available only through Ford Performance
- Off-road use only
- Manufacturer's limited lifetime warranty on axle bars and stubs, 2-year warranty on wear components



⚠ WARNING: Cancer www.P65Warnings.ca.gov

2015-2019 MUSTANG JOUNCE BUMPER & HARDWARE KIT
M-5570-B

- Fits 2015-2019 Mustang GT and 2.3L EcoBoost®
- Modified production jounce bumpers for lowered vehicles
- Includes installation hardware
- Included in the M-5300-X and M-5300-Y spring kits as well as M-FR3A-M8A and M-FR3A-MAA assembled handling packs

2015-2018 MUSTANG GT350 LOWERING SPRINGS
M-5300-W

- Fits 2015-2018 Mustang GT350 and GT350R
- Gives a more aggressive-looking stance as well as increased handling dynamics, yet maintains excellent ride quality
- Lowers car approximately 20 mm front and rear
- Works with both standard and MagneRide® suspension systems
- Designed to work with production struts, shocks and sway bars
- May cause slightly harsher ride when compared to stock springs

2015-2019 MUSTANG STREET LOWERING SPRINGS
M-5300-X

- Fits 2015-2019 Mustang GT and 2.3L EcoBoost® Coupe
- Designed to work with production struts, shocks and sway bars
- Lowers car approximately 1"
- Gives a more aggressive-looking stance as well as increased handling dynamics, yet maintains excellent ride quality
- Highest quality manufacturing – produced by OEM spring supplier
- Includes M-5570-B Jounce Bumpers
- May cause slightly harsher ride compared to stock springs



⚠ WARNING: Cancer www.P65Warnings.ca.gov

2015-2019 MUSTANG TRACK LOWERING SPRINGS
M-5300-Y

- Fits 2015-2019 Mustang GT and 2.3L EcoBoost® Coupe
- Component of the M-FR3A-M8A Track Handling Pack
- Lowers car approximately 1"
- Gives a more aggressive-looking stance with a focus on handling and on track performance
- High quality manufacturing – produced by OEM spring supplier
- Includes M-5570-B Jounce Bumpers
- Will cause slightly harsher ride compared to stock springs
- Designed to work with the M-18000-F Track Strut and Shock Kit and M-5490-E Track Sway Bar Kit
- For 1" lowering springs designed for stock struts, shocks and sway bars see M-5300-X



NOTE: Please reference a Ford service manual for installation information and correct torque specifications. May require alignment after installation.

2015-2019 MUSTANG TRACK SWAY BAR KIT M-5490-G

- Fits 2015-2019 Mustang GT and 2.3L EcoBoost® coupes and convertibles
- Fits 2015-2018 Mustang GT350 and GT350R
- Sway bar kit designed for increased handling and performance
- Works with both standard and MagneRide® suspension systems
- Includes all mounting hardware and bushings
- For replacement sway bar bushings, use M-5490-BKD Track Sway Bar Bushing Kit

NOTE: Please reference a Ford service manual for installation information and correct torque specifications. May require alignment after installation.



WARNING: Cancer www.P65Warnings.ca.gov

2015-2019 MUSTANG STREET SWAY BAR AND SPRING KIT M-5700-MA

- Fits 2015-2019 Mustang GT and 2.3L EcoBoost® coupes and convertibles
- Kit includes: M-5490-G Mustang Sway Bar Kit and M-5300-X Mustang Street Lowering Springs
- Lowers car approximately 1"
- May cause a slightly harsher ride compared to stock springs
- Gives a more aggressive-looking stance, as well as increased handling dynamics, yet maintains excellent ride quality
- Highest quality manufacturing – produced by OEM spring supplier
- Includes M-5570-B Jounce Bumpers and all sway bar mounting hardware and bushings
- For replacement sway bar bushings use M-5490-BKD Sway Bar Bushing Kit

NOTE: Please reference a Ford service manual for installation information and correct torque specifications. May require alignment after installation.



WARNING: Cancer www.P65Warnings.ca.gov

2015-2018 MUSTANG GT350 SWAY BAR AND SPRING KIT M-5700-N

- Fits 2015-2018 Mustang GT350 and GT350R
- Sway bar kit designed for increased handling and performance
- Works with both standard and MagneRide® suspension systems
- Lowers car approximately 20 mm front and rear
- May cause slightly harsher ride when compared to stock springs
- For replacement sway bar bushings use M-5490-BKD Track Sway Bar Bushing Kit

Kit includes:

- 2015-2018 Mustang GT350 M-5300-W Lowering Springs
- 2015-2018 Mustang GT350 M-5490-G Track Sway Bar Kit

NOTE: Please reference a Ford service manual for installation information and correct torque specifications. May require alignment after installation.



WARNING: Cancer www.P65Warnings.ca.gov

2015-2019 MUSTANG PERFORMANCE PACK FRONT CONTROL ARM KIT M-3075-F

- Fits 2015-2019 Mustang GT and 2.3L EcoBoost®
- Original equipment on 2015-2019 Mustang GT Performance Package
- The rearward Performance Pack front control arms are forged steel and contain a spherical bearing mount versus the tubular weldment and rubber bushing found on base Mustang
- The forward Performance Pack front control arms are forged steel and contain an air deflector to aid in brake cooling
- Includes right and left forward and rearward front Performance Pack control arms and all installation hardware



WARNING: Cancer www.P65Warnings.ca.gov

MUSTANG - 2015-2019 (CONTINUED)

TRACK SWAY BAR BUSHING KIT

M-5490-BKD

Includes all the bushings needed to rebuild the the front and rear 2015-2019 Mustang Track Sway Bar used in the following kits:

- 2015-2019 Mustang Track Handling Pack M-FR3A-M8 and M-FR3A-M8A
- 2015-2019 Mustang Street Sway Bar and Spring Kit M-5700-M and M-5700-MA
- 2015-2019 Mustang Track Sway Bar Kit M-5490-E and M-5490-G



WARNING: Cancer www.P65Warnings.ca.gov

2015-2019 MUSTANG STREET HANDLING PACK

M-FR3A-MAA*

Ford Performance assembled Street Handling Pack is the perfect suspension system for the driver who wants improved handling and a lower stance but doesn't want or need all of the benefits of the Track Handling Pack.

The Street Handling Pack includes pre-assembled struts, which do NOT require a spring compressor and are ready to bolt-in! Give your Mustang the look and performance you want with the Street Handling Pack!

Fits 2015-2019 Mustang GT and 2.3L EcoBoost® coupes and convertibles.

- All components work together as a package
- Lowers car approximately 1"
- Gives a more aggressive-looking stance with a focus on handling and street performance

Street Handling Pack includes:

- Assembled front Performance Pack struts
- Performance Pack rear shocks
- M-5300-X Street Lowering Springs
- M-18183-M Performance Pack Upper Strut Mounts
- M-5570-B Jounce Bumper Kit
- Performance Pack front and rear sway bars
- M-5972-M Performance Pack Rear Toe Links



NOTE: Any Mustang that originally came equipped with the Performance Pack option only needs the M-5300-X Street Lowering Springs to achieve the lowered ride height or upgrade to the M-FR3A-M8A Track Handling Pack.

NOTE: Please reference a Ford service manual for installation information and correct torque specifications. May require alignment after installation.



2015-2019 MUSTANG TRACK HANDLING PACK

M-FR3A-M8A*

The Ford Performance Parts assembled Track Handling Pack is the perfect suspension system for the driver who demands the most from their car on the track or on the street. Kit includes pre-assembled struts, which do NOT require a spring compressor and are ready to bolt-in! Put a little "road race" into your Mustang with Ford Performance Parts Track Handling Pack.

The Track Handling Pack is one of the most popular Ford Performance Parts upgrades for the 2015-2019 Mustang. It is used on the 2016 Hertz Shelby GT-H Mustang, 2015-2017 Shelby Super Snake and on the Ford Performance Racing School Mustang GT.

Fits 2015-2019 Mustang GT and 2.3L EcoBoost® coupes and convertibles.

- All components are designed to work together as a package
- Lowers car approximately 1.0"
- Gives a more aggressive-looking stance with a focus on handling and on track performance
- Will cause slightly harsher ride compared to stock springs
- For replacement sway bar bushings use M-5490-BKD Track Sway Bar Bushing Kit

Track Handling Pack includes:

- M-18000-F Track Strut and Shock Kit
- M-5300-Y Track Lowering Springs
- M-18183-M Front Strut Mounts
- M-5570-B Jounce Bumper Kit
- M-5490-G Track Sway Bar Kit
- M-5972-M Performance Pack Rear Toe Link Kit
- M-5A460-M Knuckle to Toe Link Bearing Assembly



NOTE: Please reference a Ford service manual for installation information and correct torque specifications. May require alignment after installation.

WARNING: Cancer www.P65Warnings.ca.gov

2015-2019 MUSTANG HANDLING PACK FASTENER KIT

M-FR3-FASTENA

- Fits: 2015-2019 Mustang GT and 2.3L EcoBoost® Coupe
- Includes all hardware that is associated with Ford Performance M-FR3A-M8A Track Handling Pack and M-FR3A-MAA Street Handling Pack



Includes hardware for the following applications:

- Front damper assembly and mounting hardware
- Front sway bar mounting hardware
- Rear toe link mounting hardware including the rear outer alignment cam
- Rear lower control arm mounting hardware
- Rear upper control arm mounting hardware
- Rear knuckle mounting hardware
- Rear sway bar mounting hardware
- Rear shock assembly and mounting hardware

2015-2019 MUSTANG GT350R STRUT TOWER BRACE KIT M-20201-GT350

- Fits 2015-2019 Left Hand Drive (LHD) Mustang GT, 2.3L EcoBoost® and GT350
- Original equipment on 2015-2017 GT350R and GT350 Track Package equipped Mustang
- Fabricated high-strength tubular aluminum
- 2.5 lbs lighter than the base GT350 stamped steel brace
- Improves handling and limits suspension flex
- Kit includes GT350R strut tower brace, cowl C-brace and mounting hardware
- Cowl C-brace only needed when car was not originally equipped with the brace

NOTE: Does not fit 2015-2017 Mustang GT with Ford Performance supercharger or 3.7L V6.

NOTE: For Right Hand Drive (RHD) Mustang, use Part No. M-20201-M350RHD.



2015-2017 MUSTANG GT350R RIGHT HAND DRIVE STRUT TOWER BRACE KIT M-20201-M350RHD

- Fits 2015-2017 Right Hand Drive (RHD) Mustang GT 5.0L and 2.3L EcoBoost®
- Original equipment on 2015-2017 GT350R and GT350 Track Package equipped Mustang
- Fabricated high-strength tubular aluminum
- 2.5 lbs lighter than the base GT350 stamped steel brace
- Improves handling and limits suspension flex
- Kit includes GT350R strut tower brace, cowl C-brace and mounting hardware
- Cowl C-brace only needed when car was not originally equipped with the brace

NOTE: Does not fit 2015-2017 Mustang GT with Ford Performance supercharger or 3.7L V6.

NOTE: This part is for use on Right Hand Drive (RHD) Mustang only. For Left Hand Drive (LHD) Mustang, use Part No. M-20201-GT350



2015-2019 MUSTANG FORD PERFORMANCE STRUT TOWER BRACE M-20201-MA

- Fits 2015-2019 Mustang GT 5.0L and 2.3L EcoBoost®
- Stamped steel beam design
- Kit includes rear cowl brace and mounting hardware
- Black powdercoated brace with stainless steel "Ford Performance" emblem

NOTE: Does not fit 2015-2019 Mustang GT with Ford Performance supercharger or 3.7L V6.



2015-2017 MUSTANG RIGHT HAND DRIVE STRUT TOWER BRACE M-20201-MARHD

- Fits 2015-2017 Right Hand Drive (RHD) Mustang GT 5.0L and 2.3L EcoBoost®
- Stamped steel beam design
- Kit includes rear cowl brace and mounting hardware
- Black powdercoated brace with stainless steel "Ford Performance" emblem

NOTE: Does not fit 2015-2017 Mustang GT with Ford Performance supercharger or 3.7L V6.

NOTE: This part is for Right Hand Drive (RHD) Mustang only. For Left Hand Drive (LHD) Mustang, use Part No. M-20201-MA.



MUSTANG - 2015-2019 (CONTINUED)

2015-2019 MUSTANG DRIVESHAFT LOOP
M-5478-6M

- Fits 2015-2019 Mustang with one-piece driveshaft only!
- Similar to M-5478-CJ Cobra Jet Driveshaft Loop
- Meets most drag racing sanctioning body requirements
- Contains driveshaft in the event of front U-joint breakage



NEW FORD PERFORMANCE MUSTANG MAGNERIDE® HANDLING PACK
M-9602-M*

The Ford Performance MagneRide® Handling Pack has been developed to maximize the handling potential of MagneRide® equipped Mustangs. The kit includes unique springs, sway bars, and a Vehicle Dynamics Module (VDM) software update that provides a substantial improvement to MagneRide® Vehicles handling performance.

- Fits 2018-2019 Mustang Coupe and Convertible models equipped with MagneRide®
- Provides improved handling with unique Ford Performance springs and sway bars
- VDM Calibration ensures compatibility between hardware and software

The MagneRide® Handling Pack includes:

- M-5300-W Spring Kit
- M-5490-G Sway Bar Kit
- MagneRide® Performance Pack VDM Software Upgrade

NOTE: Customers with a Performance Pack 2 equipped Mustang can upgrade by installing only the M-5300-W Spring Kit and M-5490-G Sway Bar Kit.



WARNING: Cancer www.P65Warnings.ca.gov

2015-2019 GT350 BRAKE UPGRADE KIT
M-2300-AA

- Fits 2015-2019 Mustang GT350
- Upgrades the stock GT350 matte black brake calipers to the desirable gloss red calipers
- Original equipment on 2015-2018 GT350R
- Brembo® 6-piston gloss red aluminum fixed front calipers
- Brembo® 4-piston gloss red aluminum rear calipers
- Front rotors are 15.5" cross-drilled with directional vanes
- Rear rotors are 14.9" cross-drilled

Kit includes:

- GT350R front calipers
- GT350R front rotors
- GT350R front brake pads
- GT350R rear calipers
- GT350R rear rotors
- GT350R rear brake pads
- All needed hardware



2015-2017 MUSTANG REAR BRAKE KIT
M-2300-MR

- Fits 2015-2017 Mustang GT and 2.3L EcoBoost®
- Production rear brake components used on the 2015-2017 Mustang GT
- Kit is designed for use with M-5970-M Mustang IRS Knuckle Kit used in custom vehicle construction

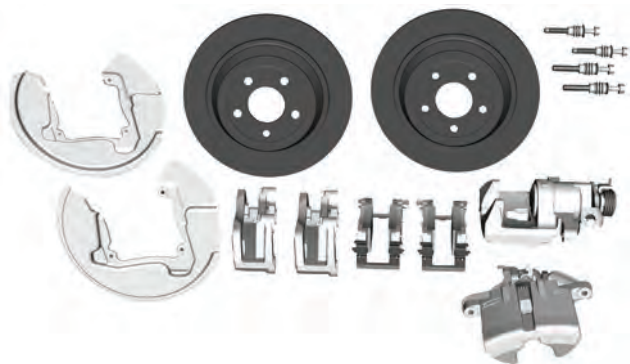

Kit includes:

- Right and left brake calipers
- Caliper brackets
- Brake rotors
- Right and left brake splash shields
- Brake splash shield mounting hardware
- Brake pads
- Caliper slide pin kit
- Caliper bracket bolts

2015-2019 MUSTANG PERFORMANCE PACK 6-PISTON FRONT BRAKE KIT

M-2300-V

- Fits 2015-2019 Mustang GT and 2.3L EcoBoost®
- Original equipment on 2015-2019 Mustang GT Performance Package
- Brembo® 6-piston satin black aluminum calipers
- 15" vented brake rotors
- Includes production brake pads, rotors, dust shields and installation hardware
- Requires Ford Performance wheels M-1007-M199B, M-1007-M199S, M-1007-M199SA, M-1007-M199DS or equivalent for caliper clearance



NOTE: Kit includes front brake hoses to install 6-piston calipers on 2.3L EcoBoost® models. Brake hoses are not used when installing this kit on Mustang GT 5.0L models.

2015-2019 MUSTANG PERFORMANCE GT350R BRAKE KIT

M-2300-Y

- Fits 2015-2019 Mustang GT 5.0L and 2.3L EcoBoost®
- Fits both Right Hand Drive (RHD) and Left Hand Drive (LHD) Mustang
- Original equipment on 2015-2019 GT350R
- Brembo® 6-piston gloss red aluminum fixed front calipers
- Brembo® 4-piston gloss red aluminum rear calipers
- Front rotors are 15.5" cross-drilled with directional vanes
- Rear rotors are 14.9" cross-drilled

Kit includes:

- GT350R front calipers
- GT350R front rotors
- GT350R front brake pads
- Front caliper adapters
- GT350R rear calipers
- GT350R rear rotors
- GT350R rear brake pads
- GT350R parking brake assemblies
- Rear GT350R knuckle
- GT350R axle assemblies
- All needed hardware
- Detailed instructions



NOTE: Stock 2015-2019 Mustang, Mustang EcoBoost® and Mustang GT 17", 18", 19" (including non and Performance Pack) and 20" wheels will not clear the GT350R brake calipers.

NEW 2015-2019 MUSTANG BULLITT™ BRAKE KIT

M-2300-BUL

- Fits 2015-2019 Mustang GT 5.0L
- Fits 2015-2019 2.3L Mustang EcoBoost® Performance Pack
- Does NOT fit 2015-2017 Mustang V-6 or 2015-2017 Mustang Base EcoBoost® cars
- Original equipment on 2018-2019 Mustang BULLITT™

Kit includes:

- BULLITT™ Brembo 6-piston Gloss Red aluminum fixed front calipers
- BULLITT™ 15" front rotors with directional vanes
- BULLITT™ front brake pads
- BULLITT™ Single-piston Gloss Red sliding calipers
- BULLITT™ 13" rear rotors with directional vanes
- BULLITT™ rear brake pads
- Front brake hoses, front & rear splash shields and all needed hardware



2005-2019 MUSTANG "FORD PERFORMANCE" WINDSHIELD BANNER – WHITE

M-1820-MB

- Fits 2005-2019 Mustang
- Die-cut white lettering that will adhere to a properly prepared windshield
- 48" long banner with 2" tall, white "FORD PERFORMANCE" script



2005-2019 MUSTANG "FORD PERFORMANCE" WINDSHIELD BANNER – WHITE AND RED

M-1820-MR

- Fits 2005-2019 Mustang
- Die-cut lettering that will adhere to a properly prepared windshield
- 48" long banner with 2" tall "FORD PERFORMANCE" script
- Banner includes white color "FORD" and red color "PERFORMANCE" lettering
- Same banner as used in Ford Performance FP350S road race car, Ford Performance marketing vehicles, Monster Energy NASCAR® cup series, etc.



*This component is eligible for the Ford Performance Parts Limited Warranty. See the Ford Performance Parts Limited Warranty on pages 217-225 for details.

MUSTANG - 2015-2019 (CONTINUED)
2018-2019 MUSTANG "FORD PERFORMANCE" LOGO RECARO SEAT SET
M-63660005-MF

- Fits 2018-2019 Mustang GT and EcoBoost® I4 except convertibles
- Similar to the optional Recaro® sport seat found in the 2018 and 2019 Mustang GT
- This seat is equipped with an integrated headrest, seat belt pass-through openings and enhanced shoulder, back and thigh area bolsters
- Features an embroidered "Ford Performance" logo on front of seat back
- Black leather 4-way manual adjustment (driver); 2-way manual adjustment (passenger)
- Includes original equipment air bags and OCS sensor
- Manufactured for Ford Performance by Recaro®
- Sold as a pair

NEW MUSTANG ALUMINUM PEDAL KIT

M-2301-BM Manual Transmission
M-2301-BA Automatic Transmission

An aluminum pedal kit is an easy to install, subtle enhancement for those seeking to dress up the interior of their Mustang!

- Fits 2011-2017 Mustangs
- Upgrade for customers without the Premium package
- Direct replacement for stock pedals on Premium package
- Easy to install with no drilling required
- M-2301-BM includes complete accelerator pedal assembly, and clutch/brake pedal pads
- M-2301-BA includes complete accelerator pedal assembly and brake pedal pad
- Aluminum finish

2015-2019 MUSTANG "FORD PERFORMANCE" SILL PLATE SET
M-1613208-A

- Fits all 2015-2019 Mustang, GT350 and GT350R
- Original equipment on Mustang GT350
- Sill plates proudly display the "Ford Performance" logo
- Set includes both the right and left door sill plate
- Durable black ABS construction
- Easy installation

2015-2017 MUSTANG RED STARTER BUTTON INSTALLATION KIT

M-10B776-MR

The Ford Performance Parts red starter button kit is designed to replace the stock silver starter button cap found on GT and 2.3L Mustang with the popular red GT350/GT350R starter button cap, giving your car a distinctive appearance.

- Fits 2015-2017 Mustang GT 5.0L and 2.3L EcoBoost®
- Kit includes a GT350 red starter button cap and replacement trim clips to use as needed
- Thorough installation instructions and available installation video

2015-2019 MUSTANG DECK LID TRIM PANEL

M-16600-MA

- Fits all 2015-2019 Mustang models
- Customize the appearance of the rear of your 2015-2019 Mustang with the Ford Performance deck lid trim panel
- This is the production trim panel from the 2018-2019 Mustang that is pulled from the production mold before the mounting holes for the "Running Horse" or "GT" badges are placed in the part. The part is finished in gloss black. This is the perfect "blank canvas" to create a special custom look for any 2015-2019 Mustang. The provision for the rear mounted camera is retained.
- Includes complete deck lid trim panel

2015-2019 MUSTANG HOOD LIFT KIT WITH LASER ENGRAVED "FORD PERFORMANCE" LOGO

M-16826-MA

Simply start to lift your hood and let the hood lift system take over. Your hood will lift and hold firmly at the raised position – no wind or bumping will knock your hood down on your head. These gas struts are rated at 90 lbs to hold up OEM and specialty hoods. Due to the leverage when open, a 90 lbs rated strut will keep the hood open securely.

- Fits 2015-2019 Mustang and Mustang BULLITT™. Does not fit GT350
- Ford Performance hood lift kit w/laser engraved "Ford Performance" logo
- 90-lb rating
- Designed for all OEM base Mustang, Mustang GT and many aftermarket hoods
- These hood lifts utilize two gas struts that lift and hold the hood without the need for a prop rod
- Made from lightweight steel and aluminum, they feature a durable black powdercoated finish to give your engine bay a much cleaner appearance
- Includes the necessary mounting brackets
- If your aftermarket hood is lighter than the factory hood, use caution when opening the hood due to the power of the strut



2015-2019 MUSTANG BILLET ENGINE CAP SET W/ LASER ENGRAVED "FORD PERFORMANCE" LOGO

M-6766-M50A

Billet aluminum CNC machined cap covers with the "Ford Performance" logo laser engraved in the top. Each cap cover is designed to push into place over the existing engine cap and is held in place with double sided tape. The cap covers are clear anodized to protect the finish and maintain long lasting beauty.

- Fits 2015-2019 Mustang GT 5.0L and 2.3L EcoBoost®
- Fits 2015-2019 Mustang GT350 5.2L

Set includes:

- Engine oil cap
- Engine oil cap insert for all EcoBoost® and 2018 and newer 5.0L applications
- Brake reservoir cap
- Radiator overflow tank cap
- Windshield washer reservoir cap
- Supercharger intercooler reservoir cap



NOTE: The supercharger intercooler reservoir cap works with Ford Performance supercharger kit M-6066-M8627 and is not used on non-supercharged applications.

NEW 2018-2019 MUSTANG GT COYOTE ENGINE COVER KIT

M-9680-M50B

- Original equipment on 2018-2019 Mustang GT 5.0L Coyote engine
- Intake cover includes "5.0" emblem
- Includes "Powered by Ford" script on both RH and LH sides
- Includes oil filler neck, which enables the reuse of engine oil cap
- Cover is molded in silver/gray finish

NOTE: Does not fit 2011-2017 Mustang engines.



NEW 2018-2019 5.0L "POWERED BY FORD" ENGINE DRESS UP KIT

M-9680-M50BA

Directly from the 2019 Mustang BULLITT™, this kit is designed to finish off the look of 2018+ 5.0L Coyote-powered vehicles.



Features:

- Kit fits 2018-2019 "Coyote" 5.0L TiVCT engines
- Kit cleans up engine bay by covering fuel rail, injectors, and wiring with desirable "Powered by Ford" script on trim pieces (brackets)
- OEM parts off 2019 Mustang BULLITT™

Includes:

- Driver side trim (bracket)
- Passenger side trim (bracket)
- PCV hoses
- Hardware

NOTE: This kit is installed instead of the engine cover included on 5.0L Mustang. Will not work with production engine cover or M-9680-M50B

NEW 2018-2019 MUSTANG SUPERCHARGER COIL COVER KIT

M-9608-M50SC

Quickly and easily improve the styling of your 2018-2019 Supercharged Mustang by adding these Supercharger coil covers.

Features:

- Quick and easy installation
- Significant improvement in under-hood appearance
- Made from composite materials designed to withstand extreme under-hood temperatures
- Complements M-6066-M8 2018-2019 Mustang GT Ford Performance/Roush Supercharger Kit
- Includes covers and attachment hardware



NOTE: Not validated for use with Superchargers other than Ford Performance/Roush 2018-2019 Mustang GT Ford Performance/Roush Supercharger Kits

2015-2019 MUSTANG TIE DOWN KIT

M-1700-M

- Includes hooks for front and rear tie-down of Mustang for transport
- Rear hooks mount just in front of rear tires on frame rail
- Front hooks attach to frame rail next to k-member
- Includes installation instructions
- As used on 2016 Cobra Jet
- Coupe/fastback only – does not fit convertible vehicles



2015-2019 MUSTANG LUG NUT KIT

M-1012-M

- Fits 2015-2019 Mustang, Mustang GT, GT350 and GT350R
- Fits new M14 x 1.5 wheel stud
- Kit contains 5 lug nuts



2015-2019 MUSTANG BLACK LUG NUTS

M-1012-MB

- Fits 2015-2019 Mustang, Mustang GT, GT350 and GT350R
- Fits 2017-2019 Ford GT
- Original equipment on the 2017-2019 Ford GT
- Fits M14 x 1.5 wheel stud
- Kit contains 5 lug nuts
- Ford Performance Parts black lug nuts use physical vapor deposition technology (PVD), which provides a scratch- and wear-resistant finish that ensures a perfect look for an extended period of time under intense use and provides surface wear resistance that cannot be provided by electroplating, anodizing or lacquer



NOTE: Hand installation and removal with non-marring lug nut sockets is strongly recommended to prevent surface damage to the black lug nuts.

MUSTANG - 2015-2019 (CONTINUED)
2015-2019 MUSTANG OPEN BACK LUG NUT KIT
M-1012-N

- Fits 2015-2019 Mustang, Mustang GT, GT350 and GT350R
- Kit contains 5 lug nuts
- Fits new M14 x 1.5 wheel stud
- Included with Ford Performance Parts M-1104-AB Front Wheel Hub Kit with Extended ARP® Studs
- Included with Ford Performance Parts M-1104-B Rear Wheel Hub Kit with Extended ARP® Studs
- Can be used with Ford Performance Parts M-1107-C Wheel Stud Kit

2015-2019 MUSTANG/FORD GT BLACK LUG NUT VEHICLE KIT
M-1012K-MB

- Fits 2015-2019 Mustang, Mustang GT, GT350 and GT350R
- Fits 2017-2019 Ford GT
- Original equipment on the 2017-2019 Ford GT
- Ford Performance Parts black lug nuts use physical vapor deposition technology (PVD), which provides a scratch and wear resistant finish that ensures a perfect look for an extended period of time under intense use and provides surface wear resistance that cannot be provided by electroplating, anodizing or lacquer
- Fits M14 x 1.5 wheel stud
- Kit contains 20 lug nuts



NOTE: Hand installation and removal with non-marring lug nut sockets is strongly recommended to prevent surface damage to the black lug nuts.

NEW MUSTANG/GT350 EXTENDED WHEEL STUD AND NUT KITS
M-1107-E Front
M-1107-F Rear

These are serious wheel stud and nut kits as used on GT350RC and GT4 road race cars. They are intended for use on the FP350S, GT4, GT350RC and track cars. These studs demonstrate high quality, strength and resistance to thread galling in repeated wheel removal/installation cycles.

- Aircraft quality alloy steel
- Baked on CT-10 coating with Teflon and moly studs
- Teflon base nut coating
- Recommended torque: 90-95 lb-ft
- 10 studs and nuts included per kit

M-1107-E features:

- Fits 2015-2019 Mustang, Mustang GT and GT350
- Stud size: 14 mm x 1.5
- Thread length from shoulder: 54 mm

M-1107-F features:

- Fits 2017-2019 GT350R
- Stud size: 14 mm x 1.5
- Thread length from shoulder: 57 mm

FORD PERFORMANCE WHEEL CENTER CAP
M-1096-FP3

- Fits 2015-2019 Mustang
- Fits 2016-2018 Focus RS
- “Ford Performance” logo on a gloss black background

2015-2019 MUSTANG WHEEL CENTER CAP – PONY EMBLEM
M-1096-O

- Fits 2015-2019 Mustang with 19" wheels
- Chrome “Running Horse” on a black background

2015-2019 GT350 FRONT TOW HOOK ASSEMBLY
M-17954-FA

- Fits 2015-2019 Shelby GT350 & GT350R
- Original equipment on Shelby FP350S
- Bright red powdercoat finish
- Bolts in place – no welding required
- Front upper grille requires modification to install

2015-2019 MUSTANG REAR TOW HOOK ASSEMBLY
M-17954-RB

- Fits 2015-2019 Shelby GT350 & GT350R
- Fits 2015-2019 Mustang GT front and rear locations
- Original equipment on Shelby FP350S
- Bright red powdercoat finish
- Bolts in place – no welding required
- Requires the removal of center mount reverse light



2015-2017 MUSTANG FENDER COVERS (PAIR) M-1822-M

- Protect your 2015-2017 Mustang GT, V6 or I4 from scratches with these molded plastic front fender covers
- Sourced right from the Ford Flat Rock Assembly Plant, home of the Mustang, where they are used in production
- A unique, one-time opportunity part for the serious Mustang enthusiast
- Quantities are very limited and it is unlikely these will be available in the future
- Includes both right- and left-side fender covers
- Does not fit Mustang GT350



2015-2019 MUSTANG GT PERFORMANCE PACK REAR WHEEL 19" X 9.5" – MATTE BLACK M-1007-M1995B

- Fits 2015-2019 Mustang
- Same styling as on the 2015-2018 Mustang GT Performance Pack wheel with a unique Ford Performance paint finish
- Paint finish clearcoated to OEM standards
- Includes the Ford Performance M-1096-FP3 Center Cap
- Clears Performance Pack brakes
- Use with M-1180-B TPMS Sensor and Activation Tool Kit
- Valve stem TPMS compatible
- 19" x 9.5" wide
- 5-lug, 114 mm (4.5") bolt circle



- 52.5 mm offset
- 186 mm backspacing

2015-2019 MUSTANG GT PERFORMANCE PACK FRONT WHEEL 19" X 9" – MATTE BLACK M-1007-M199B

- Fits 2015-2019 Mustang
- Same styling as on the 2015-2018 Mustang GT Performance Pack wheel with a unique Ford Performance paint finish
- Paint finish clearcoated to OEM standards
- Includes the Ford Performance M-1096-FP3 Center Cap
- Clears Performance Pack brakes
- Use with M-1180-B TPMS Sensor and Activation Tool Kit
- Valve stem TPMS compatible
- 19" x 9" wide
- 5-lug, 114 mm (4.5") bolt circle



- 45 mm offset
- 172 mm backspacing

2015-2019 MUSTANG GT 19" X 9" & 19" X 9.5" PERFORMANCE PACK WHEEL SET WITH TPMS KIT – MATTE BLACK M-1007K-M19XB

- Fits 2015-2019 Mustang
- Clears Performance Pack brakes
- Paint finish clearcoated to OEM standards
- Includes 19" x 9" front wheels and 19" x 9.5" rear wheels
- Includes the Ford Performance M-1096-FP3 Center Cap
- Includes M-1180-B TPMS Sensor and Activation Tool Kit
- 5-lug, 114 mm (4.5") bolt circle
- 52.5 mm offset on 19" x 9.5" wheel and 45 mm offset on 19" x 9" wheel
- 186 mm backspacing on 19" x 9.5" wheel and 172 mm backspacing on 19" x 9" wheel



⚠ WARNING: Cancer www.P65Warnings.ca.gov

2015-2019 MUSTANG "HP" PERFORMANCE PACK MATTE BLACK WHEELS

M-1007-DC1995MB	Front – 19" x 9.5" (Mustang GT and EcoBoost® Models)
M-1007-DC1910MB	Rear – 19" x 10" (Mustang GT and EcoBoost® Models)
M-1007-DC19105MB	Front – 19" x 10.5" (Mustang GT Performance Pack 2 Models)
M-1007-DC1911MB	Rear – 19" x 11" (Mustang GT Performance Pack 2 Models)

These Ford Performance Parts "HP" wheels are born from the bold and exciting 2018 Mustang Performance Pack 2 vehicles. These wheels are available in two front and two rear wheel sizes to fit 2015-2019 Mustang GT and EcoBoost® models.

All wheels feature:

- Matte black paint finish, clearcoated to OEM standards
- Similar to the 2018 Mustang Performance Pack 2 wheel with a unique Ford Performance paint finish
- Includes M-1096-FP3 "Ford Performance" Center Cap
- Clears Performance Pack 6-piston brakes
- Use with M-1180-B TPMS Sensor Activation and Tool Kit
- Valve stem TPMS compatible
- 5-lug, 114 mm (4.5") bolt circle
- Also available as a four wheel set – 19" x 10.5" fronts and 19" x 11" rears – M-1007K-DC19XMB for vehicles originally equipped with the Performance Pack Level 2 option



M-1007-DC19105MB shown above



M-1007K-DC19XMB four wheel set option

NOTE: The M-1007-DC19105MB and M-1007-DC1911MB sizes are intended for use only on vehicles originally equipped with the Performance Pack Level 2 option. Use on other vehicles may result in tire-to-body/chassis clearance issues.

MUSTANG - 2015-2019 (CONTINUED)

2015-2019 MUSTANG AND F-150 TPMS SENSOR AND ACTIVATION TOOL KIT

M-1180-B

- Fits 2015-2019 Mustang
- Fits 2015-2019 F-150
- Fits 2017-2019 F-150 Raptor
- Kit contains 4 valve-mounted snap-in tire pressure monitor sensors (valve stem TPMS) and tire pressure monitor activation tool
- Mustang and F-150 require that tire pressure monitor sensors are installed and properly activated
- Failure to install and activate sensors will cause tire pressure monitor light to remain on
- Activation tool can be used to retrain sensors after tire rotation
- **WARNING:** Requires wheels specifically designed for valve-mounted snap-in tire pressure monitor sensors

NOTE: Will NOT work on 2007-2014 Mustang V6, GT or GT500.

NOTE: For use on North American LHD Mustang only.

NOTE: Valve stems are not designed for speeds over 155 mph.



WARNING: Cancer www.P65Warnings.ca.gov

2015-2019 MUSTANG BLACK TPMS SENSOR AND ACTIVATION TOOL KIT

M-1180-C

- Fits 2015-2019 Mustang, Mustang GT, GT350 and GT350R
- Fits 2017-2019 Ford GT
- Original equipment on the 2017-2018 Ford GT
- Ford Performance Parts TPMS sensors have a black metallic stem finished using physical vapor deposition technology (PVD), which provides a scratch and wear resistant finish that ensures a perfect look for an extended period of time under intense use and provides surface wear resistance that cannot be provided by electroplating, anodizing or lacquer
- Kit contains 4 bolt-in valve-mounted tire pressure monitor sensors with black PVD coated stems and tire pressure monitor activation tool
- Mustang and GT require that tire pressure monitor sensors are installed and properly activated
- Failure to install and activate sensors will cause tire pressure monitor light to remain on
- Activation tool can be used to retrain sensors after tire rotation

NOTE: For use on North American LHD models only.

NOTE: Requires wheels specifically designed for valve-mounted tire pressure monitor sensors.



WARNING: Cancer www.P65Warnings.ca.gov

ProCal

PERFORMANCE CALIBRATIONS

ProCal is included in select Cold Air Kits, Power Upgrade Packages, and Supercharger Kits



Ford Performance Calibrations are engineered to generate optimal horsepower and torque, while delivering:

- Engine Durability
- Exceptional Drivability
- 50-State Emissions Compliancy

ProCal Tool – New and Improved!

- Enhanced features: now accepts input for axle ratio and tire size
- Easy-to-read display
- Step-by-step calibration loading instructions
- OBD II diagnostic code display capability

Trust Ford Performance ProCal to unlock your vehicle's potential without putting your powertrain at risk.



FORD PERFORMANCE

performanceparts.ford.com





CALIBRATED FOR PERFORMANCE

Power Upgrades: Practice and Pitfalls

Engineers from Ford Performance Parts are often asked, “Why do certain companies claim bigger power increases with their upgrade kits than you do with your kits?”

It’s a simple question, but the answer is fairly complex. As a starting point, though, calibrations from FPP for items such as its cold-air and supercharger kits are done by Ford engineers who, in many cases, have prior experience working on actual production vehicles.

“Ford Performance engineers have resources that no one else has,” says Dennis Gomes, who is Mod Shop director/calibration, for Tasca Automotive Group, Inc. Gomes has seen a lot of performance installations – FPP and others – and has good reasons why Ford Performance is their first choice.

“Ford’s tunes are conservative, but the drivability is always there,” he says. “Other calibrations are set up for max horsepower, but you can often get hesitations and surges.”

Some aftermarket tuners simply exaggerate the throttle response giving their customers the illusion of more power. While this feels impressive for “seat of the pants” acceleration, driving in bumper-to-bumper traffic becomes a chore as the overly anxious butterfly anticipates WOT (wide-open throttle) every time the accelerator pedal is touched. This is an extreme compromise in drivability for the daily commuter who was simply looking to unlock usable power. FPP calibrations provide a balanced approach with practical throttle mapping.

No one is more familiar with Ford engines and control systems than Ford engineers, and they take great care to develop ideal calibrations, starting with vital dynamometer testing. For some aftermarket upgrade “tunes,” the same is not necessarily so.

First, depending on how the dyno test was conducted, the real power increase might not have been as much as claimed. And second, without the proper calibration, any power increase can be harmful to powertrain durability and drivability.

Chassis Dyno Testing

There are two types of chassis dynos in widespread use today – inertia, and eddy current. Without going into too much detail, these different types measure power in totally different ways. The only common denominator is that the drive wheels of the vehicle spin on a device that measures power output at the wheels.

As a starting point, power measurements before and after an upgrade installation have to be done on the same type of dyno (preferably the same dyno) if you want to get meaningful results.

Beyond that, there are standard correction factors that have to be applied, to compensate for varying conditions like humidity, barometric pressure and air temperature. You have to be sure the same standards were used for the before and after dyno tests. It is also critical to keep test conditions for each run as similar as possible.

At a minimum, this data must be collected for each run:

- Ambient air temperature
- Barometric pressure
- Inlet air temperature (on a forced-induction car, this is usually downstream of the power adder)
- Air / fuel (A/F) ratio (preferably upstream of any catalyst)

A/F ratio is the single most important parameter to measure accurately, and Ford Performance Parts also uses these other data inputs to get ideal dyno testing and calibration:

- Air / fuel ratio and spark advance commanded by the PCM
- Fuel injector pulse width
- Fuel pump duty cycle (in the case of ERFS)
- MAF sensor voltage
- Fuel pressure
- Engine oil temperature
- Differential oil temperature



Ford Performance Techline (800)367-3788



ProCal is included in select Cold Air Kits, Power Upgrade Packages, and Supercharger Kits.



Powertrain Control Module Calibration

There's also the matter of the engine's internal conditions, which are monitored and adjusted-for by the powertrain control module (and the way it's calibrated). Ford Performance Parts calibrations, like Ford production calibrations, are developed with certain protections against damage, both short-term and long-term, caused by particular internal conditions – mainly heat.



One example is protection against overly hot catalyst temperatures, which can cause permanent damage. A production PCM will continually calculate the hottest temperature in a catalyst, and if it exceeds a predetermined limit, the PCM will richen the A/F ratio to lower the exhaust gas temperature until the catalyst has cooled sufficiently. Of course a richer A/F ratio will also reduce power output.

What does this mean? Well, suppose a car – a supercharged production vehicle with a production calibration – is driven to a dyno facility and a run is performed immediately, resulting in a reading of 700 hp. Then a part is swapped out for a “high-performance” version and the car is run again; the reading is 710 hp. The high-performance part is worth 10 hp, right? Wrong. In this hypothetical example, the dyno operator was not monitoring A/F ratio, and didn't realize that in the first run, with the engine fully up to temperature, the catalyst protection function kicked in, richened the A/F ratio, and reduced power output. In the second run, the engine had cooled enough that the catalyst protection wasn't needed and the A/F ratio remained optimal. So the results were misleading; it wasn't an apples-to-apples comparison.

That example may be trivial, but it shows how vital the essential data input is to getting correct results. In this case, if the A/F ratio had been monitored, the discrepancy would have been immediately apparent.

Similar misleading results can be caused by a failure to keep inlet air temperature constant between runs. As inlet air temperature increases, the PCM will retard spark timing to prevent detonation, lowering power output.

Some aftermarket cold-air kit manufacturers claim enormous power gains using nothing more than their kit and a production calibration. Most of these claims are not supported with A/F, inlet temperature, or spark advance traces during the dyno pulls shown in their advertising.

In some cases, the apparent increase in power is because the mass air flow sensor transfer function in the PCM is left stock. With the new cold-air kit flowing more air, the stock PCM will not “know” about the extra air that's entering the engine, causing an A/F ratio that is leaner than it should be for durability. This can produce more power, but it also can be damaging to catalysts, exhaust valves, piston rings, and other engine components. The commanded spark advance can also be incorrect, and result in detonation or pre-ignition with potentially catastrophic results.

The bottom line is; a healthy dose of caution and skepticism is a good thing when approaching high-performance power upgrades. Some aftermarket tuners do a few “tricks” that Ford Motor Company does not recommend, such as:

- Turning off the catalyst, oxygen sensor and exhaust valve temperature protection logic. This can result in more power under certain conditions, but the downside is drastically decreased durability of these expensive components.
- Advancing spark timing to potentially unsafe levels that can cause detonation or pre-ignition.

So the answer to the opening question is, some power increase claims are based on poor and misleading dynamometer test practices. Others are genuine but at the expense of engine, catalyst, or drivetrain durability. Even driver safety is sometimes overlooked for horsepower.



Ford Performance Parts Calibrations

Ford Performance Parts tests its calibrations extensively, in a wide range of conditions. Ford engineers take extreme care to provide as much power and torque as can safely be delivered, and also deliver high durability and exceptional drivability. In the area of automatic transmission calibration, they generally make extensive changes to improve shift quality and give the transmission a more performance-oriented feel, without compromising durability.

Most other companies do not have the time or resources to test to the extent Ford Performance Parts does. Some do not realize they need to test at all!

In fact, most FPP kits are 50-state emissions compliant and many offer a warranty. Customers can be sure of a quality product that will continue to deliver improved performance over the long term and meet CARB standards. ■

*This component is eligible for the Ford Performance Parts Limited Warranty. See the Ford Performance Parts Limited Warranty on pages 217-225 for details.

FORD MUSTANG

2014-EARLIER



MUSTANG – 2014 AND EARLIER

2005-2009 MUSTANG V6 POWER UPGRADE PACKAGE M-2007-FR1V6



- Fits 2005-2009 Mustang V6 with manual or automatic transmission
- Approximate increase of 15 peak hp and up to 17 lb-ft over stock

Kit includes:

- Ford Performance ProCal II tool with performance calibration for significantly improved throttle response and performance feel
- M-9603-V605 2005-2009 Mustang V6 Cold Air Kit With Performance Calibration
- M-5230-V6 2005-2009 Mustang V6 Touring Dual Exhaust Kit (50 State)
- CM-6731-FL820 High Performance Oil Filter
- Utilizes production quality components which mount in the stock location. The high-flow molded plastic bucket features a painted "Ford Racing" logo with unique clean-air tube which provides an enhanced intake sound

- Premium (91 octane or higher) fuel only
- Due to multiple powertrain calibrations, online registration is required to receive ProCal calibration delivery tool after purchase
- Ford Performance does not ship ProCal tools directly overseas. Customers must make special arrangements with their Ford Performance Distributor
- Powertrain calibrations are developed and supported for U.S. and Canadian vehicles only
- Unlike many of our competitors, this Ford Performance Power Upgrade Package is 50-state emissions legal with CARB EO (D-598-4)
- Federal and state laws prohibit any person from installing aftermarket add-on or modified parts prior to the sale of a new motor vehicle



2011-2014 MUSTANG GT POWER UPGRADE PACKAGE M-FR1-MGTB



- Fits 2011-2014 Mustang GT
- For 2005-2009 Mustang GT, see M-FR1-MGT1. For 2010 Mustang GT, see M-FR1-MGTA
- Approximate peak increase of 16 hp and 7 lb-ft on 93 octane fuel
- Up to 60 lb-ft increase at 1500 rpm!
- Skip-shift disable (2011-2012 only, not necessary on 2013-2014 models)

Kit includes:

- Ford Performance ProCal II tool with performance calibration
- 2011-2014 Mustang GT M-9601-MGT High-Flow K&N/Ford Performance Air Filter
- 2011-2014 Mustang M-5230-MGTCA1 GT Muffler Kit (50 State)
- CM-6731-FL820 High Performance Oil Filter
- Premium (91 octane or higher) fuel only
- Due to multiple powertrain calibrations, online registration is required to receive ProCal calibration delivery tool after purchase
- Ford Performance does not ship ProCal tools directly overseas. Customers must make special arrangements with their Ford Performance Distributor
- Powertrain calibrations are developed and supported for U.S. and Canadian vehicles only
- Unlike many of our competitors, this Ford Performance Power Upgrade Package is 50-state emissions legal with CARB EO (D-598-12) and eligible for limited warranty when installed by a Ford or Lincoln dealer
- Federal and state laws prohibit any person from installing aftermarket add-on or modified parts prior to the sale of a new motor vehicle



WARNING: Cancer www.P65Warnings.ca.gov

Call the Ford Performance Techline at (800)367-3788

MUSTANG - 2014-EARLIER (CONTINUED)

5.0L COBRA JET COLD AIR KIT

M-9603-M50CJ

- Fits 2011-2014 Mustang GT and 2012-2013 BOSS 302 with Cobra Jet 5.0L M-9424-M50CJ Intake Manifold
- Intake manifold requires throttle body M-9926-MSVT, M-9926-CJ65 or M-9926-SCJ
- High-flow filter, high-flow molded plastic air filter bucket and unique clean-air inlet tube with "Ford Racing" logo
- 102 mm air inlet diameter
- Design based on 5.0L NA Cobra Jet race car
- 2013-2014 Mustang GT heat extractor may allow drainage of water onto air filter. Modify as necessary
- Calibration is necessary to prevent engine damage! Calibration not included!

NOTE: CJ inlet tube does not have provisions for aspirator tube hook up common to automatic transmission equipped 2011-2014 Mustang GT.



WARNING: Cancer www.P65Warnings.ca.gov

2011-2014 MUSTANG GT FORD PERFORMANCE CALIBRATION WITH HIGH FLOW K&N AIR FILTER

M-9603-MGTB



- Fits 2011-2014 Mustang GT
- For 2005-2009 Mustang GT, see M-9603-GTB
- Approximate peak increase of 16 hp and 7 lb-ft on 93 octane fuel
- Up to 60 lb-ft increase at 1500 rpm!
- Eliminates skip shift on 2011-2012 manual transmission applications

Kit includes:

- Ford Performance ProCal II tool with performance calibration
- 2010-2014 Mustang GT M-9601-MGT High-Flow K&N/Ford Performance Air Filter
- Premium (91 octane or higher) fuel only
- Due to multiple powertrain calibrations, online registration is required to receive ProCal calibration delivery tool after purchase
- Ford Performance does not ship ProCal tools directly overseas. Customers must make special arrangements with their Ford Performance Distributor
- Powertrain calibrations are developed and supported for U.S. and Canadian vehicles only
- Unlike many of our competitors, this Ford Performance Power Upgrade Package is 50-state emissions legal and eligible for limited warranty when installed by a Ford or Lincoln dealer
- Federal and state laws prohibit any person from installing aftermarket add-on or modified parts prior to the sale of a new motor vehicle

WARNING: Cancer www.P65Warnings.ca.gov



2005-2009 MUSTANG V6 4.0L COLD AIR TUNER KIT (CALIBRATION REQUIRED)

M-9603-M40



- Fits 2005-2009 Mustang V6 with manual or automatic transmission
- Designed for those who want the Ford Performance cold air intake for aftermarket performance tuning/calibration
- Kit comes with hardware only! Calibration not included! Kit intended for aftermarket calibrators
- Ford Performance cold air kit utilizes production quality components which mount in the stock location. The higher flowing molded plastic bucket features a painted "Ford Racing" logo with unique air tube providing an enhanced intake sound and 85 mm mass air meter housing (reuse of mass air meter sensor required)
- For replacement air filter element, see M-9601-B
- Calibration is necessary to prevent engine damage, calibration not included

WARNING: Cancer www.P65Warnings.ca.gov





2005-2009 MUSTANG V6 COLD AIR KIT WITH PERFORMANCE CALIBRATION

M-9603-V605

- Fits 2005-2009 Mustang V6 with manual or automatic transmission
- Approximate increase of 12 peak hp – up to 13 lb-ft over stock

Kit includes:

- Ford Performance ProCal II tool with performance calibration for significantly improved throttle response and performance feel. A certified pre-owned ProCal tool may be provided
- Disposable M-9601-B Air Filter Element
- Utilizes production quality components which mount in the stock location. The high-flow molded plastic bucket features a painted “Ford Racing” logo with unique clean-air tube which provides an enhanced intake sound
- Premium (91 octane or higher) fuel only
- Due to multiple powertrain calibrations, online registration is required to receive ProCal calibration delivery tool after purchase
- Ford Performance does not ship ProCal tools directly overseas. Customers must make special arrangements with their Ford Performance Distributor
- Powertrain calibrations are developed and supported for U.S. and Canadian vehicles only
- Unlike many of our competitors, this Ford Performance Power Upgrade Package is 50-state emissions legal
- Federal and state laws prohibit any person from installing aftermarket add-on or modified parts prior to the sale of a new motor vehicle



WARNING: Cancer www.P65Warnings.ca.gov

2005-2009 MUSTANG GT/V6 COLD AIR KIT DISPOSABLE HIGH-FLOW AIR FILTER REPLACEMENT

M-9601-B

- Replacement disposable air filter for Ford Performance 2005-2009 Mustang GT M-9603-GTB Cold Air Kit, 2005-2009 Mustang V6 M-9603-V605 Cold Air Kit, 2005-2009 Mustang V6 4.0L M-9603-M40 Cold Air Kit and 2005-2009 Mustang V6 M-9603-V605 Cold Air Kit
- Original equipment replacement air filter for 2008-2009 Mustang BULLITT™. Not for use with stock 2005-2010 Mustang GT or V6 air-box



WARNING: Cancer www.P65Warnings.ca.gov

AIR FILTER ELEMENT

M-9601-C

- Service replacement air filter for M-9603-GT06 Cold Air Kit



WARNING: Cancer www.P65Warnings.ca.gov

2007-2009 MUSTANG SVT COLD AIR AND SUPERCHARGER UPGRADE KIT REPLACEMENT AIR FILTER

M-9601-D

- Replacement air filter for the 2007-2009 Mustang SVT 113 mm M-9603-SVT07 Cold Air Kit and M-6066-SGT Supercharger Upgrade Kit



WARNING: Cancer www.P65Warnings.ca.gov

2010-2014 MUSTANG GT & 2011-2014 V6 HIGH-FLOW K&N / FORD PERFORMANCE AIR FILTER

M-9601-MGT

K&N 4 ply panel washable air filter.

- Fits stock 2010-2014 Mustang GT air-box. **Will NOT fit 2005-2009**
- Fits stock 2011-2014 Mustang V6 air-box. **Will NOT fit 2005-2010**
- Fits stock 2012-2013 Mustang BOSS 302
- Flows approximately 22% more than stock filter at 1.5" H2O delta pressure
- Co-engineered by K&N and Ford Performance
- Does not require PCM recalibration



WARNING: Cancer www.P65Warnings.ca.gov

MUSTANG - 2014-EARLIER (CONTINUED)

2013-2014 MUSTANG GT CALIBRATION TRACK CAL

M-14204-MGTTTC Track Cal 2013-2014 Mustang GT
M-14204-MGTTTCU Track Cal Update 2013-2014 Mustang GT

TrackKey and Track Cal are Ford Performance exclusive calibrations that provide added functionality to 2013-2014 Mustang GT with manual transmission. TrackKey is also available for 2012-2013 BOSS 302.

Both calibrations include these exclusive features:

- Driver adjustable Launch Control, or "2-step engine speed limiting"
- Driver adjustable Pit Lane Speed Control
- "Lopey" idle
- Improved engine performance – up to 60 lb-ft at 1500 rpm & peak increases of 16 hp and 7 lb-ft on 93 octane fuel

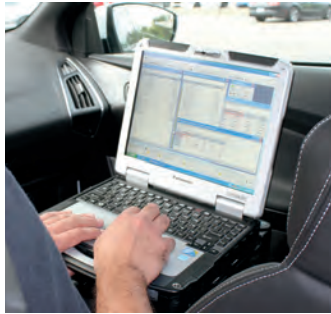

TrackKey or Track Cal – Which is right for me?

- TrackKey provides the customer a unique key that activates the calibration once it has been installed. TrackKey is sold and installed exclusively through U.S. and Canadian Ford and Lincoln dealers. Special equipment and training is required to install TrackKey. TrackKey is available for some 2014 Mustang GTs with manual transmission (build date after 7/1/2013).
- Track Cal is supplied via the exclusive ProCal flash tool. It is always active, but "lopey" idle can be turned off. Available for all 2013-2014 Mustang GTs with manual transmission.

How do TrackKey and Track Cal work?

TrackKey and Track Cal both contain exclusive calibration features designed for track use and derived from the same software algorithms and features employed in Ford Performance turnkey race cars such as the BOSS 302R, BOSS 302S and Cobra Jet.

Engine performance is similar to the calibration available in the Ford Performance M-FR1-MGTB Kit and modifies several PCM parameters, including:

- Twin Independent Variable Cam Timing (Ti-VCT)
- Engine braking
- Ignition timing
- Wide-open throttle fueling
- Accelerator pedal map
- Idle speed
- Throttle response



TrackKey and Track Cal for Mustang GT

- Alter several thousand lines of code and several hundred calibration parameters
- Are the only calibrations of their type that have gone through the rigorous Ford Performance test procedures
- Are a 50-state legal aftermarket engine performance software upgrade for the 2013-2014 Mustang GT with manual transmission (TrackKey only available on 2014 MY build date after 7/1/2013)

NOTE: Federal and state laws prohibit any person from installing aftermarket add-on or modified parts prior to the sale of a new motor vehicle.

WARNING: Cancer www.P65Warnings.ca.gov

5.4L 4V PERFORMANCE INTERCOOLER

M-6775-MSVT

- Fits 2007-2014 Mustang Shelby GT500 5.4L and 5.8L 4V engine
- Excellent upgrade for prior model GT500 and 5.4L Cobra Jet Mustangs
- Less restriction and more efficient heat extraction than earlier model intercooler
- Aluminum construction
- Standard equipment on 2013-2014 Mustang Shelby GT500
- Includes gasket to supercharger, charge cooler gasket and inlet/outlet O-rings



2011-2014 MUSTANG GT BOSS 302 RADIATOR

M-8005-MBR



- Fits 2011-2014 Mustang GT with manual transmission
- Original equipment on 2012-2013 Mustang BOSS 302
- Improved cooling over stock Mustang GT 5.0L 4V Ti-VCT radiator

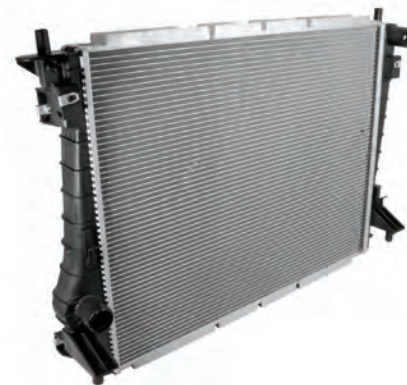

2005-2014 MUSTANG GT ALUMINUM RADIATOR

M-8005-MGT

- Fits 2005-2014 Mustang GT and 2012-2013 BOSS 302
- Service replacement part for the FR500S and BOSS 302S race car
- Uses OEM fan and mounting points for bolt-in installation
- All aluminum construction
- Increased cooling over production radiator
- Excellent upgrade for open track or road race S197 Mustang



2012-2013 MUSTANG BOSS 302 TRACKKEY M-9603-MBTKA



The highly sought after BOSS TrackKey calibration is BACK and with more features than ever before. Recently, an update to Ford software provided the inability to download TrackKey at Ford dealerships. This kit comes with a ProCal 2 calibration tool with the exclusive TrackKey calibration and a performance air filter. Additionally, this tool offers the ability to modify tire size and gear ratio settings in the calibration.



TrackKey is a 50-state legal aftermarket engine performance software upgrade for the 2012-2013 BOSS 302 and BOSS 302 Laguna Seca. It is not compatible with any other vehicle.

TrackKey is an exclusive Ford Performance calibration that provides added functionality for 2012-2013 BOSS 302 owners. This calibration includes these exclusive features:

- Driver adjustable Launch Control, or “2-step engine speed limiting”
- Driver adjustable Pit Lane Speed Control
- “Lopey” idle

TrackKey provides the customer a unique key that activates the calibration once it has been installed. TrackKey is sold through Ford Performance retailers. The calibration is downloaded via the exclusive ProCal 2 flash tool that’s included.

How does TrackKey work?

TrackKey contains exclusive calibration features designed for track use and derived from the same software algorithms and features employed in Ford Performance turn-key race cars such as the BOSS 302R, BOSS 302S and Cobra Jet.

Engine performance is similar to the calibration available in the Ford Performance M-FR1-MGTB kit and modifies several PCM parameters, including:

- Twin Independent Variable Cam Timing (Ti-VCT)
- Engine braking
- Ignition timing
- Wide-open throttle fueling
- Accelerator pedal map
- Idle speed
- Throttle response
- Skip-shift disable (available for 2012 BOSS 302, not necessary on 2013 model)

NOTE: Requires the use of 91-octane or higher (“premium”) fuels at all times. Federal and state laws prohibit any person from installing aftermarket add-on or modified parts prior to the sale of a new motor vehicle. Please see instructions. The customer’s vehicle will still have to have the key recognized as a TrackKey at any Ford dealer. For technical assistance, please contact the Ford Performance Techline at (800)367-3788.

WARNING: Cancer www.P65Warnings.ca.gov

2005-2010 MUSTANG GT DE-GAS BOTTLE M-8080-A



- Fits 2005-2010 Mustang GT
- Coolant expansion/fill tank features a billet radiator style neck
- Comes with the M-8100-A “Ford Racing” 16 lb pressure cap
- Same part as used on the Mustang FR500S race car



RADIATOR CAP WITH FORD RACING LOGO M-8100-A



- Fits most radiators
- Service replacement for the Mustang FR500S race car
- 16 lb cap
- Does not fit production de-gas bottles



2011-2012 MUSTANG SHELBY GT500 SPORT MUFFLER KIT (49 STATE) M-5230-MSVTLA



- Fits 2011-2012 Mustang Shelby GT500
- 304 stainless steel muffler body construction
- 304 stainless steel chrome-plated “Ford Racing” embossed 4” tips
- Louder, throatier exhaust note
- Requires factory muffler clamps
- 49-state drive-by noise legal (not legal in CA)



2013-2014 MUSTANG SHELBY GT500 SPORT MUFFLER KIT (49 STATE) M-5230-MSVTLB



- Fits 2013-2014 Mustang Shelby GT500
- 304 stainless steel muffler body construction
- 304 stainless steel chrome-plated 4” tips
- Louder, throatier exhaust note
- 49-state drive-by noise legal (not legal in CA)



MUSTANG - 2014-EARLIER (CONTINUED)
2005-2009 MUSTANG GT / 2007-2009 MUSTANG SHELBY GT500 "S" MUFFLER KIT (49 STATE)
M-5230-S

- Fits 2005-2009 Mustang GT
- Fits 2007-2009 Mustang Shelby GT500
- Meets 95 decibel drive-by noise standard for aftermarket exhaust systems when installed on stock applications
- Throatier exhaust note
- 409 aluminized stainless steel corrosion-resistant muffler body construction
- Polished 304 stainless steel 3.5" diameter tips
- For 2010 Mustang GT and Shelby GT500 see M-5230-SA



NOTE: 409 stainless exhaust material is titanium stabilized ferritic stainless steel. 409 stainless is used in applications where appearance is a secondary consideration to mechanical properties and corrosion resistance and where some weldability is required. An example of 409 stainless usage is catalytic converter assemblies. 409 stainless has excellent forming characteristics and is rust-through resistant. A surface rust will form in most instances. This rust retards further corrosion.

2005-2009 MUSTANG GT SPECIAL EDITION MUSTANG MUFFLER KIT
M-5230-GTB

- Fits 2005-2009 Mustang GT
- Meets 95 decibel drive-by noise standard for aftermarket exhaust systems when installed on stock applications
- Muffler used as standard equipment on the 2008 Mustang BULLITT™
- Throatier exhaust note
- 409 aluminized stainless steel corrosion-resistant muffler body construction with polished 304 stainless steel 3.5" diameter tips

2011-2014 MUSTANG GT MUFFLER KIT (49 STATE)
M-5230-MGTC1

- Fits 2011-2014 Mustang GT
- 409 aluminized stainless steel corrosion-resistant muffler body construction with polished 304 stainless steel 4" diameter tips
- Mufflers were standard on 2011-2012 Mustang Shelby GT500
- Throatier exhaust note
- Meets 95 decibel drive-by noise standard for aftermarket exhaust systems when installed on stock applications



NOTE: 409 stainless exhaust material is titanium stabilized ferritic stainless steel. 409 stainless is used in applications where appearance is a secondary consideration to mechanical properties and corrosion resistance and where some weldability is required. An example of 409 stainless usage is catalytic converter assemblies. 409 stainless has excellent forming characteristics and is rust-through resistant. A surface rust will form in most instances. This rust retards further corrosion.

⚠ WARNING: Cancer www.P65Warnings.ca.gov

2011-2014 MUSTANG GT & 2011-2012 GT500 3-INCH EXHAUST SYSTEM
M-5230-MGTC30

- Fits 2011-2014 Mustang GT and 2011-2012 GT500
- **Cat-back exhaust system**
- 3" exhaust system delivers an aggressive exhaust sound
- Includes X-pipe for improved flow
- Polished 4.5" exhaust tips feature embossed "Ford Racing" logo
- 49-state legal mufflers



⚠ WARNING: Cancer www.P65Warnings.ca.gov

2011-2014 MUSTANG GT/BOSS SPORT MUFFLER KIT (49 STATE)
M-5230-MGTLA

- Fits 2011-2014 Mustang GT.
- Fits 2012-2013 Mustang BOSS
- 304 stainless steel muffler body construction with 304 stainless steel chrome plated "Ford Racing" embossed 4" exhaust tips
- Louder, throatier exhaust note
- Designed to eliminate exhaust drone at sustained RPMs
- Requires factory muffler clamps
- 49 state drive-by noise legal (not legal in CA)



2013-2014 MUSTANG GT AXLE BACK QUAD TIP MUFFLERS WITH REAR LOWER VALANCE

M-5230-MSVTC

- Fits 2013-2014 Mustang GT
- 409 aluminized stainless steel corrosion-resistant muffler body construction with twin polished 304 stainless steel 4" diameter tips
- Mufflers are original equipment on 2013-2014 Mustang Shelby GT500
- Throatier exhaust note
- Clamp-on installation
- Shelby GT500 rear lower valance includes installation hardware
- Cutting of original lower fascia required for installation of GT500 valance
- Meets 95 decibel drive-by noise standard for aftermarket exhaust systems when installed on stock applications



MUSTANG GT X-PIPE

M-5251-R 2005-2010 Mustang GT

M-5251-MGTA 2011-2014 Mustang GT (Built After 5/10/10)



- 409 stainless steel X-pipe
- Converts your factory H-pipe to a more efficient X-pipe
- M-5251-R requires cutting of factory exhaust for installation
- Clamp-on installation – does not require welding!
- M-5251-R kit includes 2 clamps
- M-5251-MGTA installs using existing factory clamps



WARNING: Cancer www.P65Warnings.ca.gov

2011-2014 MUSTANG V6 TOURING MUFFLERS (50 STATE)

M-5230-MV6CA



- Fits 2011-2014 Mustang V6
- 304 stainless steel construction
- Louder, throatier exhaust note
- Includes mufflers with 3.5" exhaust tips
- Meets 95 decibel drive-by noise standard for aftermarket exhaust systems when installed on stock applications



2011-2014 MUSTANG V6 SPORT MUFFLERS (49 STATE LEGAL)

M-5230-MV6LA



- Fits 2011-2014 Mustang V6
- 304 stainless-steel muffler body construction with 304 stainless steel chrome-plated 3.5" tips
- Louder, throatier exhaust note
- Requires factory muffler clamps
- 49-state drive-by noise legal (not legal in CA)



2005-2009 MUSTANG V6 TOURING DUAL EXHAUST KIT

M-5230-V6



- Fits 2005-2009 Mustang V6
- Louder, throatier exhaust note
- Meets 95 decibel drive-by noise standard for aftermarket exhaust systems when installed on stock applications
- Includes M-5230-GTB Mufflers used as standard equipment on the 2008 special edition Mustang
- 409 aluminized stainless steel muffler body construction with polished 304 stainless steel 3.5" diameter tips
- Includes 409 stainless steel X-pipe
- Requires minor modification of rear bumper cover (template included in kit)

NOTE: 409 stainless exhaust material is titanium stabilized ferritic stainless steel. 409 stainless is used in applications where appearance is a secondary consideration to mechanical properties and corrosion resistance and where some weldability is required. An example of 409 stainless usage is catalytic converter assemblies. 409 stainless has excellent forming characteristics and is rust-through resistant. A surface rust will form in most instances. This rust retards further corrosion.



MUSTANG - 2014-EARLIER (CONTINUED)

2011-2014 MUSTANG V6 X-PIPE
M-5251-MV6A



- Fits 2011-2014 Mustang V6
- 409 stainless steel X-pipe
- Converts your factory H-pipe to a more efficient X-pipe
- Requires cutting of factory exhaust for installation
- Clamp on installation – does not require welding!



WARNING: Cancer www.P65Warnings.ca.gov

“STAGE 8” LOCKING HEADER BOLT SYSTEM



PART NUMBER	SIZE	FITS
M-9432-A50	3/8"-16 x .75"	Most headers on push rod engines
M-9432-A51	3/8"-16 x 1"	Ford Performance “Shorty” headers on push rod engines

- These kits fit most V8 and many other engines
- Includes 16 bolts and locking hardware
- 100% reliable, zero failures in more than 17,000,000 applications. Header fasteners will not back out. Eliminates need to monitor and tighten bolts regularly
- Grade 8 aircraft quality bolts made in U.S.A. Duplex nickel plated
- Manufacturer’s Lifetime Warranty



ASSEMBLED MUSTANG HANDLING PACKS



M-FR3A-MGTAA shown

2005-2014 MUSTANG GT COUPE ASSEMBLED HANDLING PACK
M-FR3A-MGTA

The Ford Performance assembled handling pack includes pre-assembled struts. No spring compressor required, strut/spring assembly is ready to bolt in! Put a little “road race” into your Mustang GT with the Ford Performance handling pack. It’s tuned to deliver improved handling without sacrificing ride quality.

- Fits 2005-2014 Mustang GT Coupe
- All components are designed to work together as a package
- Lowers car approximately 1"

Handling Pack includes:

- M-18000-A Assembled Front Struts with rear shocks, M-5300-P Lowering Springs, M-18183-C Upgraded Strut Mount and M-5570-A Jounce Stops
- M-5490-A Sway Bar Kit
- M-4264-A Adjustable Rear Panhard Bar
- Includes all factory required one-time use fasteners

NOTE: Some factory fasteners are one-time use. Please reference service manual for reuse information and correct torque specifications. Requires alignment after installation.

WARNING: Cancer www.P65Warnings.ca.gov

2005-2014 MUSTANG GT COUPE ASSEMBLED HANDLING PACK ADJUSTABLE
M-FR3A-MGTAA

The Ford Performance assembled handling pack includes pre-assembled struts and springs. No spring compressor required, strut/spring assembly is ready to bolt in! Make your Mustang GT a corner-carving machine with the added performance of an adjustable FR3 Handling Pack. The adjustable struts/shocks allow you to tune your suspension to street or track conditions. One click using the supplied tool adjusts for both compression and rebound.

- Fits 2005-2014 Mustang GT Coupe
- All components are designed to work together as a package
- Lowers car approximately 1"

Handling Pack includes:

- Assembled adjustable M-18000-C Front Struts with adjustable rear shocks, M-5300-P Lowering Springs, M-18183-C Upgraded Strut Mount and M-5570-A Jounce Stops
- M-5490-A Sway Bar Kit
- M-4264-A Adjustable Rear Panhard Bar
- Includes all factory required one-time use fasteners

NOTE: Some factory fasteners are one-time use. Please reference service manual for reuse information and correct torque specifications. Requires alignment after installation.

WARNING: Cancer www.P65Warnings.ca.gov

2005-2014 MUSTANG HANDLING PACK FASTENER KIT M-FR3-FASTENERS

- Fits 2005-2014 Mustang GT
- Includes all hardware that is associated with Ford Performance M-FR3A-MGTA Handling Pack and M-FR3A-MGTAA Handling Pack

Includes hardware for the following applications:

- Brake line retaining bolt (front)
- Sway bar bracket nut (front & rear)
- Rear jounce bumper bolt
- Strut top mount nut
- Rear lower shock bolt
- Rear lower shock nut
- Panhard rod nut
- Panhard rod bolt
- Front end chassis brace nut
- Front sway bar end-link nut
- Strut to knuckle bolt
- Front end chassis brace bolt



2007-2014 MUSTANG SVT COUPE HANDLING PACK

M-FR3-MSVTA Unassembled
M-FR3A-MSVTA Assembled

Make your 2007-2014 Shelby GT500 a corner-carving machine with the added performance of the Ford Performance FR3 Handling Pack. The pack is uniquely tuned to fit the 2007-2014 Shelby GT500 Coupe (does not fit 2013-2014 Track Pack).

- Lowers 2007-2012 approximately 1.25". All components are designed to work together as a package
- Lowers 2013-2014 approximately .400" front, 1.000" rear
- M-20201-C Strut Tower Brace recommended for 2007-2009 Shelby GT500
- M-20201-MSVTC recommended for 2010 Shelby GT500
- Struts/Shocks are adjustable and manufactured by Dynamic® Suspensions (the same company that makes struts/shocks for the Ford Performance Mustang road race car)

Handling Pack includes:

- M-18000-C Adjustable Struts/Shocks
- M-5300-L Lowering Springs
- M-5490-B Sway Bar Kit
- M-18183-C Upper Strut Mounts
- M-5570-A Jounce Bumpers

NOTE: Some factory fasteners are one-time use. Please reference a Ford service manual for reuse information and correct torque specifications. May require alignment after installation.

WARNING: Cancer www.P65Warnings.ca.gov



2005-2014 MUSTANG COUPE DYNAMIC STRUT/SOCK KIT

M-18000-A Kit
M-18001-AF Single Front Strut for Service
M-18001-AR1 Single Rear Strut for Service

- Fits 2005-2010 Mustang GT and Mustang V6
- Will fit 2011-2014 Mustang GT and Mustang V6. Requires Ford Performance springs and M-18183-C Upper Strut Mounts
- Dynamic® Suspension strut/shock, same manufacturer as Mustang road race car
- Unique Ford Performance tune
- Designed specifically for lowered vehicles
- Mustang GT Coupe owners: Use with M-5300-K or M-5300-P Springs and M-5490-A Sway Bar Kit for optimum performance
- Mustang V6 Coupe owners: Use with M-5300-N Springs and M-5490-C Sway Bar Kit for optimum performance



2005-2014 MUSTANG GT/2007-2014 MUSTANG SVT ADJUSTABLE STRUT/SOCK KIT

M-18000-C

- Fits 2007-2014 Shelby GT500 (except 2013-2014 Track Pack) and 2005-2010 Mustang GT
- Will fit 2011-2014 Mustang GT. Requires use of Ford Performance springs and M-18183-C Upper Strut Mounts
- Engineered specifically for improved handling on both stock ride height and lowered 2007-2012 Mustang SVT and 2005-2014 Mustang GT
- Single adjustment with two-way response
- Recommended for Mustang SVT use with M-5300-L Spring Kit, M-5490-B Sway Bar Kit and M-20201-C Strut Tower Brace (2007-2009 Mustang SVT only)
- Recommended for Mustang GT use with M-5300-P Spring Kit (1" drop), M-5300-K Spring Kit (1.5" drop), M-5490-A Sway Bar Kit and M-20201-S197 Strut Tower Brace
- Will not fit 2013-2014 GT500 Track Pack

NOTE: Some factory fasteners are one-time use. Please reference a Ford service manual for reuse information and correct torque specifications. May require alignment after installation.



MUSTANG - 2014-EARLIER (CONTINUED)

2005-2014 MUSTANG FRONT STRUT MOUNT UPGRADE (PAIR)
M-18183-C

- Fits 2005-2010 Mustang V6/GT and 2007-2014 Shelby GT500
- Will fit 2011-2014 Mustang V6 when used with Ford Performance M-18000-A or M-18000-C Dampers and M-5300-N Springs
- Will fit 2011-2014 Mustang GT when used with Ford Performance M-18000-A or M-18000-C Dampers and M-5300-K or M-5300-P Springs
- Original equipment on the 2011-2014 Shelby GT500 Coupe
- Increased durometer over base strut mount



MUSTANG REAR UPPER SHOCK MOUNT
M-18197-A

- Service replacement for the Ford Performance Mustang road race cars, FR500S, BOSS 302R and BOSS 302S
- Used to install eyelet-style coilover dampers on the rear of a 2005-2012 Mustang
- Bolt-in design/weld-in optional
- Sold in pairs



MUSTANG FRONT/REAR SPRING KITS

- Fits 1979-2004 Mustang
- Lower your Mustang and improve handling
- The height on some cars will vary

PART NUMBER	MODEL YEAR	AMOUNT LOWERED (V8)		SPRING RATES (LB/IN)	
		FRONT	REAR	FRONT	REAR
M-5300-B ⑤	1979-2004 ④	.875" ①	.5" ②	425/530	200/300
M-5300-C ⑤	1979-2004 ④	.875" ①	.5" ②	650	200/300
M-5300-G ③⑤	1979-2004 ④	1.2"	1.2"	500/570	170/310

NOTE: Expect some deterioration in ride quality.

- ① 1994-2004 models – 1-1/8"
- ② 1994-2004 models – 3/4"
- ③ Convertible only
- ④ Will not fit 1999-2004 Cobra
- ⑤ Due to vehicle assembly tolerances, these specifications may vary



2005-2014 MUSTANG JOUNCE BUMPER KIT
M-5570-A

- Fits 2005-2014 Mustang V6, GT and 2007-2011 Shelby GT500
- GT500 jounce bumpers designed for improved stability/ride comfort when used in conjunction with Ford Performance Parts lowering springs
- Original equipment on 2012-2014 Shelby GT500
- Recommended for lowered vehicles
- Includes front and rear jounce bumpers



2013 COBRA JET SPRING KIT
M-5300-RA



- Improved performance and stance compared to prior offerings
- Allows full range of adjustment with M-5649-CJ Stock Cobra Jet Rear Suspension
- Excellent upgrade for 2008-2012 Cobra Jet or any 2005-2013 Mustang set up for drag racing
- As used on the 2013 Mustang Cobra Jet program



2005-2014 MUSTANG GT COUPE STREET LOWERING SPRINGS
M-5300-KA



- Fits 2005-2010 Mustang GT Coupe
- Fits 2011-2014 Mustang GT Coupe when used with GT500 M-18183-C Strut Mount Upgrade Kit
- Gives a more aggressive looking stance as well as increased handling dynamics
- Lowers car approximately 1.5"
- Progressive spring, designed for increased handling and performance
- Use with M-18000-A, M-18000-C and M-5490-A for optimum performance
- GT500 M-5570-A Mustang Jounce Bumper Kit recommended with installation of springs
- May cause slightly harsher ride compared to stock springs
- GT500 M-18183-C Strut Mount Upgrade Kit recommended for 2005-2010 Mustang GT



NOTE: Some factory fasteners are one-time use. Please reference a Ford service manual for reuse information and correct torque specifications. May require alignment after installation.

2007-2014 MUSTANG SHELBY GT500 SPRINGS M-5300-L



- Fits 2007-2014 Mustang Shelby GT500 Coupe
- Gives a more aggressive-looking stance, as well as increased handling dynamics
- Validated for use with electronically controlled Track Pack option (2013-2014 model year)
- Lowers 2007-2012 approximately 1.25"
- Lowers 2013-2014 approximately .4" front, 1" rear
- May cause slightly harsher ride compared to stock springs
- Recommended for use with M-18000-C Damper Kit and M-5490-B Sway Bar Kit (except 2013-2014 Track Pack)
- M-5570-A Mustang Jounce Bumper Kit recommended with installation of springs (original equipment on 2012-2014, recommended for 2007-2011)
- M-18183-C Strut Mounts recommended (original equipment on 2012-2014, recommended for 2007-2011)



NOTE: Some factory fasteners are one-time use. Please reference a Ford service manual for reuse information and correct torque specifications. May require alignment after installation.

2005-2014 MUSTANG GT TRACK LOWERING SPRINGS M-5300-PA



- Fits 2005-2010 Mustang GT Coupe
- Fits 2011-2014 Mustang GT Coupe when used with M-18183-C Upper Strut Mounts and M-18000-A Shocks/Struts or M-18000-C Adjustable Shocks/Struts
- Gives a more aggressive looking stance as well as increased handling dynamics
- Lowers car approximately 1"
- Progressive spring, designed for increased handling and performance
- Use with M-18000-A, M-18000-C and M-5490-A for optimum performance
- M-5570-A Mustang Jounce Bumper Kit recommended with installation of springs
- May cause slightly harsher ride compared to stock springs
- M-18183-C Strut Mounts recommended for 2005-2010 Mustang GT



NOTE: Some factory fasteners are one-time use. Please reference a Ford service manual for reuse information and correct torque specifications. May require alignment after installation.

2012-2013 BOSS 302 LOWERING SPRINGS M-5300-T

- Fits 2012-2013 Mustang BOSS 302 and BOSS 302 Laguna Seca edition
- Gives a more aggressive looking stance as well as increased handling dynamics
- Lowers car approximately 15 mm (0.6") front and 35 mm (1.375") rear
- Includes M-5570-A Mustang Jounce Bumper Kit
- May cause slightly harsher ride compared to stock springs



NOTE: Some factory fasteners are one-time use. Please reference a Ford service manual for reuse information and correct torque specifications. May require alignment after installation.

SWAY BAR KITS



2005-2014 MUSTANG GT COUPE SWAY BAR KIT M-5490-A*

- Sway bar kit designed for increased handling and performance on 2005-2014 Mustang GT Coupe
- Best when used with M-18000-A or M-18000-C Struts/Shocks and M-5300-K Springs (1.5" drop), or M-5300-P Springs (1" drop)
- Includes all mounting hardware
- For replacement bushings use M-5490-BKA Bushing Kit

2007-2012 MUSTANG SVT SWAY BAR KIT M-5490-B*

- Sway bar kit designed for increased handling and performance on 2007-2012 Shelby GT500 Coupe
- Front bar: 35 mm, tubular; Rear bar: 24 mm, solid
- Designed to be used with M-18000-C Dampers, M-5300-L Springs and M-20201-C Brace (2007-2009 only)
- Includes all mounting hardware

2005-2014 MUSTANG GT CONVERTIBLE SWAY BAR KIT M-5490-D*

- Sway bar kit designed for increased handling and performance on 2005-2014 Mustang GT Convertible
- Best when used with M-18000-A Strut/Shock Kit or M-18000-C Adjustable Strut/Shock Kit
- Includes all mounting hardware

***NOTE:** Some factory fasteners are one-time use. Please reference a Ford service manual for reuse information and correct torque specifications.



WARNING: Cancer www.P65Warnings.ca.gov

M-5490-A shown

BUSHING KITS



ANTI-ROLL BAR/SWAY BAR REPLACEMENT BUSHING KITS

M-5490-BKA

Includes all the bushings to rebuild the M-5490-A Sway Bar Kit.

M-5490-BKB

Includes all the bushings to rebuild the M-5490-B Sway Bar Kit.

M-5490-BKC

Includes all the bushings to rebuild the M-5490-C or M-5490-D Sway Bar Kit.



NOTE: Urethane bushings should be checked every 12 months of use

WARNING: Cancer www.P65Warnings.ca.gov

MUSTANG - 2014-EARLIER (CONTINUED)
ANTI-ROLL BAR / SWAY BAR COMPLETE HARDWARE KITS
M-5490-HWA*

- Includes all the hardware and bushings to rebuild the M-5490-A Sway Bar Kit

M-5490-HWB*

- Includes all the hardware and bushings to rebuild the M-5490-B Sway Bar Kit

M-5490-HWC*

- Includes all the hardware and bushings to rebuild the M-5490-C and M-5490-D Sway Bar Kit

***NOTE:** Sway bars not included

WARNING: Cancer www.P65Warnings.ca.gov

ANTI-ROLL BAR/SWAY BAR REPLACEMENT END LINK
M-5490-LINKA*

- Fits M-5490-A Sway Bar Kit

M-5490-LINKB*

- Fits M-5490-B Sway Bar Kit

M-5490-LINKC*

- Fits M-5490-C and M-5490-D sway bar kits

***NOTE:** Includes one sway bar link with bushings

WARNING: Cancer www.P65Warnings.ca.gov

2005-2014 MUSTANG V6 STRUT TOWER BRACE M-20201-F

- Fits 2005-2014 Mustang V6
- Silver powdercoated with etched "Ford Racing" logo
- Parallel beam design for added rigidity

NOTE: Some factory fasteners are one-time use. Please reference a Ford service manual for reuse information and correct torque specifications.

2005-2014 MUSTANG GT STRUT TOWER BRACE M-20201-S197

- Fits 2005-2010 Mustang GT without engine dress-up cover
- Fits 2011-2014 Mustang GT with engine dress-up cover
- Parallel beam design for added rigidity
- Black powdercoated
- Stainless steel "Ford Racing" emblem
- Does not fit V6, supercharged Mustang GT, or 2005-2010 Mustang GT with engine dress-up cover
- Does not fit with M-9424-463V Intake Manifold

NOTE: Some factory fasteners are one-time use. Please reference a Ford service manual for reuse information and correct torque specifications.

2005-2010 MUSTANG GT FRONT LOWER CONTROL ARM UPGRADE KIT
M-3075-E

- Fits 2005-2010 Mustang GT built on or before 8/3/09 with 18 mm ball joint shaft
- Original equipment on 2007-2009 Shelby GT500
- Increased strength ball joints
- Kit contains 1 RH and 1 LH lower control arm assembly



NOTE: Some factory fasteners are one-time use. Please reference a Ford service manual for reuse information and correct torque specifications.

WARNING: Cancer www.P65Warnings.ca.gov

2011-2014 MUSTANG FRONT CONTROL ARM KIT WITH EXTENDED BALL JOINT
M-3075-RA

- Fits 2011-2014 Mustang
- Service replacement for 2013 Mustang BOSS 302S race car
- Ball joint is 19.2 mm longer than stock; offers improved geometry for track use
- Threaded ball joint for easy replacement
- M-5638-C Front Control Arm Bushing Kit and M-3130-R4 Bump Steer Kit recommended
- Off-road use only



WARNING: Cancer www.P65Warnings.ca.gov

BOSS 302R ELECTRIC STEERING RACK M-3200-EPAS

- Service replacement for 2012-2014 Mustang BOSS 302R race car
- Electric assist steering rack with performance calibration
- Designed for road racing with racing tires
- Off-road use only!

2005-2014 MUSTANG CASTER AND CAMBER ALIGNMENT ECCENTRIC BOLT KIT
M-3B236-A

- The caster and camber eccentric kit contains everything you need to adjust the caster and camber on your 2005-2014 Mustang
- Fits 2005-2014 Mustang

Kit contains:

- Both front camber eccentric bolts
- Both front caster eccentric bolts
- All needed hardware



2005-2009 MUSTANG GT COUPE FRONT LOWER A-ARM BRACE UPGRADE KIT



M-5025-A

- Fits 2005-2009 Mustang GT Coupe
- Original equipment on convertible and 2007-2009 Shelby GT500
- Increases chassis stiffness



WHEEL NUTS (5-PACK)



M-1012-G

- Fits 2005-2014 Mustang and most other 1/2"-20 applications
- Service replacement for the Mustang FR500S and BOSS 302S race car
- 1/2"-20 thread plated steel cone seat lug nuts
- Open-ended for use with long wheel studs
- 13/16" hex



2005-2014 MUSTANG V6 / BOSS / GT / SHELBY GT500 HUB KIT WITH ARP STUDS

M-1104-A

- Fits 2005-2014 Mustang V6, BOSS, GT, Shelby GT500
- Service replacement part for the Mustang FR500S and BOSS 302S race car
- Equipped with M-1107-A ARP® Front Wheel Studs
- 3" ARP® stud specifications: wheel stud style – press-in; thread size – 1/2"-20 RH; knurl diameter – .549"; under head length – 3.315"



Kit includes:

- One pair of upgrade hubs with 3" ARP® studs
- New hub nut

NOTE: For replacement open end wheel lug nuts see M-1012-G.

1979-1993 MUSTANG / CAPRI FRONT LOWER CONTROL ARM KIT



M-3075-A

- Fits 1979-1993 Mustang/ Capri
- Kit includes LH and RH lower control arm assemblies (produced on original Ford production tooling), greaseable ball joint, ball joint boot, grease fittings, nut and cotter pin
- Dramatically improves impact harshness qualities of vehicle on early Fox bodies (1979-1984)
- Recommended when heavy-duty suspension components are added



- Fits other Fox bodies:
- 1978-1982 Fairmont/Zephyr
- 1980-1982 Thunderbird/Cougar
- 1981-1982 Granada/Monarch
- 1983-1985 LTD/Marquis

WARNING: Cancer www.P65Warnings.ca.gov

2005-2014 MUSTANG BUMP STEER KIT

M-3130-R4

- Fits 2005-2014 Mustang
- Service replacement for 2013 Mustang BOSS 302S race car
- Allows adjustment of bump steer after making changes to control arm geometry, control arm position or if you have significantly increased caster
- Kit includes pair of spherical rod ends, tapered stud, assortment of spacers and hardware
- Toe adjustments are easily made without tire removal
- Off-road use only!



MUSTANG ROAD RACE REAR LOWER CONTROL ARM BUSHINGS

M-5638-A

- Service replacement part for Mustang FR500C and BOSS 302R race car
- Replacement bushings for rear lower control arms
- Includes 8 bushings and 4 sleeves



2005-2014 MUSTANG COMPETITION FRONT BUSHING KIT

M-5638-C

- Fits Mustang BOSS 302R, FR500C, FR500S, 2005-2014 Mustang GT, V6, Shelby GT500 and 2012-2013 Mustang BOSS 302
- Front lower control arm bushing kit for 2005-2014 Mustang
- Original equipment on 2013 Mustang Cobra Jet and Mustang BOSS 302S
- Rear bushings are smaller and lighter than production – ideal for header access
- Low drag Delrin®/Aluminum forward bushings remove the bushing as a damping force
- Increased stiffness for minimal suspension deflection and increased steering response
- Off-road use only!



2005-2014 MUSTANG ADJUSTABLE PANHARD BAR

M-4264-A

- Fits 2005-2014 Mustang
- Service replacement part for the FR500S and BOSS 302 R1 race car
- Also for use on NASA AI and AIX class S197 Mustangs
- Allows adjustment to the rear suspension vs. the factory non-adjustable bar
- 1.125" OD x .095" wall thickness 4130 chrome moly bar
- Low deflection urethane rod ends and steel sleeves
- Offset mounts allow bar to clear rear differential cover
- For replacement bushings use 2005-2014 Mustang M-4266-A Adjustable Panhard Bar Bushing Kit



Call the Ford Performance Techline at (800)367-3788

MUSTANG - 2014-EARLIER (CONTINUED)
2005-2014 MUSTANG ADJUSTABLE PANHARD BAR BUSHING KIT
M-4266-A

- Service replacement bushing kit for Ford Performance 2005-2014 M-4264-A Adjustable Panhard Bar

Kit includes:

- Steel bushing sleeves
- Urethane bushings

2005-2014 MUSTANG REAR LOWER CONTROL ARM UPGRADE KIT
M-5538-A

- Fits 2005-2011 Mustang GT, 2005-2014 Mustang GT with auto transmission, and 2005-2014 Mustang V6
- Standard equipment on 2007-2014 Shelby GT500, 2013-2014 Mustang GT with Track Pack, and 2011-2014 Mustang GT with manual transmission
- Increased bushing durometer and stiffness for high-performance applications
- For race applications see M-5649-S or M-5649-R1 tubular control arm kits

NOTE: Some factory fasteners are one-time use. Please reference service manual for reuse information and correct torque specifications

2005-2014 MUSTANG TUBULAR REAR LOWER CONTROL ARM KIT - URETHANE BUSHINGS
M-5649-R1

- Fits all 2005-2014 Mustang V6, GT, Shelby GT500 and 2012-2013 BOSS 302
- Service replacement for the Mustang FR500C and BOSS 302R race car
- Features low deflection urethane bushings and tubular steel construction
- Increased stiffness for minimal suspension deflection
- The kit comes complete with bushings and sleeves and can be installed with basic shop tools
- Great for use with M-5650-A Rear Control Arm Relocation Bracket
- Replacement M-5638-A Urethane Bushing/Sleeve Kit available
- For street applications, see M-5538-A Control Arm Kit
- For tubular control arms with spherical bearing ends, see M-5649-S Control Arm Kit

2005-2014 MUSTANG TUBULAR REAR LOWER CONTROL ARM KIT - SPHERICAL BEARING
M-5649-S

- Fits 2005-2014 Mustang GT and 2007-2014 Shelby GT500
- Service replacement part for 2012 Mustang BOSS 302S race car
- Made from steel tube with high-strength spherical rod ends
- Increased stiffness for minimal suspension deflection
- Non-adjustable
- Off-road use only
- Great for use with M-5650-A Rear Control Arm Relocation Bracket
- For street applications see M-5538-A Control Arm Kit
- For tubular control arms with urethane bushings see M-5649-R1 Control Arm Kit

2005-2014 MUSTANG LOWER CONTROL ARM RELOCATION BRACKET
M-5650-A

- Fits 2005-2014 Mustang GT and 2007-2014 Shelby GT500
- Requires aftermarket lower control arms
- Service replacement for 2012 Mustang BOSS 302S race car
- Bracket allows adjustment of rear lower control arm mounting point at axle housing
- Allows adjustment of instant center for optimum traction
- NOT compatible with production lower control arms
- Off-road use only

2005-2010 MUSTANG V6 FRONT BRAKE UPGRADE KIT
M-2300-D

- Fits 2005-2010 Mustang V6
- Upgrades Mustang V6 11.5" front rotors to the larger Mustang GT 12.4" rotors for increased stopping power
- Uses existing calipers and brake pads
- Easy to install, no brake bleeding required
- For caliper clearance requires 17" or larger 2005-2014 Mustang GT wheels such as M-1007-T178B, M-1007-T178S, M-1007-S1885B and M-1007-DC1895



1994-2004 MUSTANG GT REAR BRAKE BRACKET UPGRADE KIT

M-2300-M



- Used to install Mustang Cobra, Mach 1, or Special Edition rear calipers on 1994-2004 Mustang GT
- Kit includes production 11.65" rotors, caliper mounting brackets, moan braces, dust shields and dust shield bolts



2005-2014 MUSTANG GT 14" SVT BRAKE UPGRADE KIT

M-2300-S

- Fits 2005-2014 Mustang GT (ABS only)
- Kit will upgrade the front brakes to 2007-2012 Shelby GT500 14" rotors and 4-piston Brembo® calipers
- Includes Shelby GT500 rear pads for use in stock Mustang GT rear calipers
- Includes Goodridge® DOT four-piece stainless steel hose kit and attaching parts
- Requires 18" M-1007-DC1895, M-1007-S1895, M-1007-S1895B1 or 19" M-1007-DC199B, M-1007-SA199 or M-1007-DC199LGB Ford Performance wheel or equivalent for caliper clearance
- Kit also clears track use only M-1007-R1895 and M-1007-R1895S 18" Mustang race wheels



WARNING: Cancer www.P65Warnings.ca.gov

2005-2014 MUSTANG GT 14" SVT BRAKE UPGRADE KIT W/ 2-PIECE ROTORS

M-2300-SA

- Fits 2005-2014 Mustang GT (ABS only)
- Kit will upgrade the front brakes to Ford Performance 2-piece 14" brake rotors and 4-piston Brembo® calipers
- Includes Shelby GT500 rear pads for use in stock Mustang GT rear calipers
- Includes Goodridge® DOT four-piece stainless steel hose kit and attaching parts
- Requires 18" M-1007-DC1895, M-1007-S1895, M-1007-S1895B1 or 19" M-1007-DC199B, M-1007-SA199 or M-1007-DC199LGB Ford Performance wheel or equivalent for caliper clearance
- Kit also clears track use only M-1007-R1895 and M-1007-R1895S 18" Mustang race wheels



WARNING: Cancer www.P65Warnings.ca.gov

2005-2014 MUSTANG SIX PISTON 15-INCH BRAKE UPGRADE KIT

M-2300-T

- Fits 2005-2014 Mustang GT Coupe
- Fits 2012-2013 BOSS 302
- Original equipment on 2013-2014 Shelby GT500
- Front features: Brembo® 6-piston gloss black aluminum calipers and 15" vented brake rotors
- Rear features: Single-piston calipers, rear axle caliper brackets and 13.8" vented brake rotors
- Includes production front brake hoses, front and rear brake pads, front tie rod heat shields and installation hardware
- Requires Ford Performance M-1007-SA199, M-1007-SA1910, M-1007-DC199LGB, M-1007-SA1995MB wheels or M-1007KIT-DC19910LGB, M-1007KIT-DC199CH, M-1007KIT-DC199LGB, M-1007KIT-SA199, M-1007KIT-SA19910 wheel kits or equivalent for caliper clearance
- Kit also clears track use only wheels, M-1007-R1895, M-1007-R1810 and M-1007-R1895S 18" Mustang Ford Performance/BBS race wheels



1994-2004 MUSTANG COBRA R FRONT BRAKE UPGRADE KIT

M-2300-X Front Brake Kit

M-2300-XP Front Brake Pads

M-2300-XR Front Brake Rotors



- Fits 1994-2004 Mustang GT and 1994-2004 Cobra
- Original equipment on 2000 Mustang Cobra R
- Brembo® 4-piston gloss black aluminum calipers
- 13" vented and slotted brake rotors
- Includes braided stainless brake lines and installation hardware
- May require larger wheels



NOTE: 1994-1995 Mustang GT requires 1994 Cobra master cylinder.

11" X 2.25" BRAKE DRUM

M-1126-B



- Brake drum for 9" axle M-2209-B Backing Plate Kit
- 5-lug, 4.5" bolt circle
- Axle center pilot hole 2.780"
- Sold individually
- Wall thickness at hub .125"
- Backspacing from outer edge to hub area 3.575"



MUSTANG - 2014-EARLIER (CONTINUED)
2005-2014 MUSTANG HIGH PERFORMANCE BRAKE COOLING SHIELDS
M-20045-MSVT

- Fits 2005-2014 Mustang GT, Mustang V6 and 2007-2012 Shelby GT500
- Protects tie rod end from heat while improving heat dissipation from front brakes
- Perfect for high-performance track use
- Replaces factory dust shield
- Original equipment on 2013-2014 Mustang Shelby GT500

MUSTANG FR500C, BOSS 302R/S BRAKE BOOSTER
M-2005-R

- Service replacement for FR500C, BOSS 302R/R1 and BOSS 302S race cars
- Specific race valving for lightweight vehicles with race tires
- Provides enhanced feedback at high speeds
- Reduced assist by 30% compared to production Mustang GT brake booster
- Revised pedal modulation for more gradual braking and less initial "bite" at initial travel
- Engineered and available exclusively through Ford Performance

2005-2014 MUSTANG BRAKE LINE UPGRADE KIT
M-2078-MB

- Fits 2005-2014 Mustang GT
- Fits 2005-2014 Mustang GT with Brembo® package
- Fits 2007-2012 Shelby GT500
- Fits 2011-2014 Mustang V6
- Brake line kit used on 2012-2013 Mustang BOSS 302
- Low expansion rubber lines for improved brake response
- Front and rear lines included

BRAKE PROPORTIONING VALVE
M-2328-C

- Compact, lightweight (.5 lb) aluminum brake proportioning valve
- "Kneepoint" is adjustable from 100 to 1000 psi
- Inlet and outlet ports have 1/8"-27 NPT threads for maximum installation flexibility

ADJUSTABLE PARKING BRAKE CABLE
M-2810-A

- Front parking brake cable for M-2300-F and M-2300-K brake kits

2005-2009 MUSTANG SVT REAR SPOILER
M-16600-SVTC

- Fits 2005-2009 Mustang GT
- Original equipment on 2007-2009 Mustang SVT
- Fits into existing Mustang GT spoiler bolt holes
- No drilling required when installed on Mustang GT with factory spoiler
- Must be painted to match color of car

2013-2014 BOSS LAGUNA SECA FRONT SPLITTER KIT
M-16601-MBA

- Fits 2013-2014 Mustang GT California Special and 2013 BOSS 302 with M-17A626-MB Splitter Kit Bracket
- Fits 2013-2014 Mustang GT and V6 with M-16601-MBKIT Install Kit
- Original equipment on 2013 BOSS 302 Laguna Seca and BOSS 302S
- Service replacement for 2013 BOSS 302 Laguna Seca and BOSS 302S
- Increases front downforce for road racing and open track applications
- Splitter made from durable ABS material
- Brackets are black powdercoated
- Includes splitter and installation hardware
- Off-road use only

2010-2012 SPLITTER HARDWARE KIT
M-16601H-MB

- Service hardware for BOSS 302 front splitter as used on BOSS 302 Laguna Seca and M-16601-MB 2010-2012 Splitter Kit

BOSS 302S FRONT SPLITTER HARDWARE KIT
M-16601H-S

- Service hardware kit for BOSS 302S race car front splitter
- Hardware kit includes fasteners and support rods for M-16601-S Splitter
- Does not include fasteners for M-17A626-MB Bracket



2005-2014 MUSTANG HOOD LIFT KIT WITH LASER-ENGRAVED "FORD PERFORMANCE" LOGO

M-16826-M



Simply start to lift your hood and let the hood lift system take over. Your hood will lift and hold firmly at the raised position – no wind or bumping will knock your hood down on your head. These gas struts are rated at 90 lbs to hold up OEM and specialty hoods.

- Fits 2005-2014 Mustang
- 90-lb rating
- Designed for all OEM base, Mustang GT, GT500 and many aftermarket hoods
- These hood lifts utilize two gas struts that lift and hold the hood without the need for a prop rod
- Made from lightweight steel and aluminum, they feature a durable black powdercoated finish to give your engine bay a much cleaner appearance
- Includes the necessary mounting brackets
- No drilling required. The stamped steel brackets included in this kit are designed to bolt into the existing mounting holes in the hood so there is no drilling required for installation
- If your aftermarket hood is lighter than the factory hood, use caution when opening the hood due to the power of the strut

2005-2014 MUSTANG LIGHTWEIGHT TUBULAR FRONT BUMPER

M-17757-MB



- Fits 2005-2014 Mustang
- For off-road competition use only!
- Service replacement part for 2013 BOSS 302S
- Powdercoated black
- Requires modifications to the front Mustang fascia to accommodate tow hook
- 8.6 lbs – 30% lighter than stock
- Includes bracket for M-17954-A Front Tow Hook
- Includes attachments for Ford Performance M-16601P-MB or M-16601-MBA splitter kits



TOW HOOK LOOP KIT

M-17954-A

- Service part for Ford Performance Fiesta Spec-B and FR500S Mustang Challenge race car
- Does not include bumper beam attaching hardware



MUSTANG FRONT TOW RING KIT

M-17954-F

- Fits 2013 Mustang GT and 2013 Mustang BOSS 302 front fascia
- Bright red tow ring pivots for ease of use
- Includes weld-on bumper beam bracket
- Front fascia requires cutting to mount tow ring kit



MUSTANG REAR TOW RING KIT

M-17954-RA

- Fits 2013 Mustang GT and 2013 Mustang BOSS 302 rear fascia
- Bright red tow ring pivots for ease of use
- Includes weld-on bumper beam bracket
- Rear fascia requires cutting to mount ring kit



2012 MUSTANG BOSS 302S FRONT GRILLE

M-8200-MBR

- Fits 2010-2012 Mustang GT and 2012 Mustang BOSS 302
- Production front grille on Ford Performance Mustang BOSS 302S race car
- Modified grille insert increases airflow to the radiator
- Fog light openings cut out and filled with heavy-duty wire mesh
- Accepts stock BOSS 302 Mustang grille emblem
- Flat black finish

MODIFIED 2013 BOSS 302S GRILLE

M-8200-MBRA

- Fits 2013 Mustang BOSS 302
- Production front grille on 2013 Ford Performance Mustang BOSS 302S race car
- Modified grille insert increases airflow to the radiator
- Fog light openings cut out and filled with heavy-duty wire mesh
- Flat black finish



MUSTANG - 2014-EARLIER (CONTINUED)

2006-2014 MUSTANG FLOOR MATS

PART NUMBER	MODEL YEAR	COLOR
M-13086-MD	2006-2009	GRAY with "MUSTANG" TAG
M-13086-ME	2006-2009	BLACK with "MUSTANG" TAG
M-13086-MF	2010	BLACK with SILVER PONY
M-13086-MG	2010	GRAY with "GT500"
M-13086-MH	2012	BLACK with SILVER PONY
M-13086-MJ	2012	BLACK with "BOSS 302"
M-13086-MM	2013-2014	BLACK with "BOSS 302"
M-13086-MN	2013-2014	BLACK with SILVER PONY
M-13086-MP	2013-2014	GRAY with "GT500"

- Premium-grade carpeting is custom fit to the exact contour of Mustang
- Dual retention on driver- and passenger-side mats



ALUMINUM AND URETHANE SPECIAL EDITION MUSTANG PEDAL COVER



- M-2301-A Accelerator Pedal Cover
- M-2301-B Brake/Clutch Pedal Cover
- M-2301-C Dead Pedal

- Fits 1994-2004 Mustang
- Direct replacement for stock pedal
- Easy to install, no drilling required
- Brushed aluminum finish with urethane knobs for better grip
- Custom styling for the muscle car enthusiast



FORD PERFORMANCE STEERING WHEEL - OFF-ROAD



M-3600-RA

- Fits 2005-2018 Mustang race cars
- Same steering wheel as used on 2013-2015 Mustang Cobra Jet and 2012-2014 Mustang BOSS 302S, BOSS 302R, FR500C and FR500S but with "Ford Performance" logo
- Requires custom wiring to retain any factory steering wheel buttons



NOTE: This steering wheel is for off-road use only.

STEERING WHEEL HUB ADAPTER



M-3602-R

- Same as used on FR500S, 2013-2014 BOSS 302S, 2013 and 2016 Cobra Jet Mustang



NEW 2010-2014 MUSTANG GT AND SHELBY GT500 BILLET ENGINE CAP SET

M-6766-M50B

Billet aluminum CNC machined cap covers with Ford Performance logo laser engraved in the tops. Each cap cover is designed to push into place over the existing engine cap and is held in place with automotive-rated double sided adhesive tape. The cap covers are clear anodized to protect the finish & maintain long lasting beauty.

Fits:

- 2010-2014 Mustang GT
- 2010-2014 Shelby GT500

Set includes:

- Engine oil cap
- Brake reservoir cap
- Radiator overflow tank cap
- Windshield washer reservoir cap
- Supercharger intercooler reservoir cap

NOTE: The supercharger intercooler reservoir cap fits the Shelby GT500 and aftermarket supercharger kit reservoir caps that use a similar Ford intercooler reservoir cap.



MUSTANG BOSS 302S 19" X 9" FRONT, 19" X 10" REAR, WHEEL SET WITH TPMS SENSOR KIT

M-1007KIT-DC19910LGB

- Wheels fit 2005-2014 Mustang GT, 2007-2012 Shelby GT500 and 2005-2014 Mustang V6
- Kit does not fit 2013-2014 Shelby GT500
- Kit includes four wheels and 2010-2014 Mustang M-1180-A TPMS Sensors and Activation Tool
- For wheel specs, see M-1007-DC199LGB or M-1007-DC19910LGB
- For TPMS specs, see M-1180-A



WARNING: Cancer www.P65Warnings.ca.gov

MUSTANG BOSS 302S 19" X 9" WHEEL SET WITH TPMS SENSOR KIT – GLOSS BLACK WITH MACHINED FACE

M-1007KIT-DC199LGB

- Wheels fit 2005-2014 Mustang GT, 2007-2012 Shelby GT500 and 2005-2014 Mustang V6
- Kit does not fit 2013-2014 Shelby GT500
- Kit includes four wheels and 2010-2014 Mustang M-1180-A TPMS Sensors and Activation Tool
- For wheel specs, see M-1007-DC199LGB or M-1007-DC19910LGB
- For TPMS specs, see M-1180-A



WARNING: Cancer www.P65Warnings.ca.gov

MUSTANG BOSS 302S REAR WHEEL 19" X 10" – GLOSS BLACK WITH MACHINED FACE

M-1007-DC1910LGB

- Fits 2005-2014 Mustang V6 and Mustang GT
- Fits 2007-2014 Shelby GT500
- Original equipment on Ford Performance Mustang BOSS 302S factory-built race car M-FR500-B302S
- Machined face with gloss black accents, clearcoated to OEM standards
- Includes Mustang "Bar and Pony" center cap M-1096-A
- For 19" x 9" BOSS 302S front wheel see M-1007-DC199LGB
- Clears OEM Brembo® brakes and M-2300-S and M-2300-T Ford Performance brake kits



- Valve stem TPMS compatible
- 19" x 10" wide
- 5-lug, 114 mm (4.5") bolt circle
- 47.5 mm offset
- 187 mm backspacing

MUSTANG BOSS 302S FRONT WHEEL 19" X 9" – GLOSS BLACK WITH MACHINED FACE

M-1007-DC199LGB

- Fits 2005-2014 Mustang V6 and Mustang GT
- Fits 2007-2014 Shelby GT500
- Standard equipment on Ford Performance BOSS 302S factory-built race car M-FR500-B302S
- Machined face with gloss black accents, clearcoated to OEM standards
- Includes Mustang M-1096-A "Bar and Pony" Center Cap
- For 19" x 10" rear wheel see M-1007-DC1910LGB
- Clears OEM Brembo® brakes and Ford Performance brake kits M-2300-S and M-2300-T



- Valve stem TPMS compatible
- 19" x 9" wide
- 5-lug, 4.5" bolt circle
- 42 mm offset
- 6.7" backspacing

2005-2014 MUSTANG 18" X 8" MESH SPOKE WHEEL – MATTE BLACK

M-1007-P188MB

- Fits 2005-2014 Mustang V6 and Mustang GT
- Matte black paint finish, clearcoated to OEM standards
- Includes "Ford Racing" M-1096-FR1 Center Cap
- Band and valve stem TPMS compatible
- 18" x 8" wide
- 5-lug, 114 mm (4.5") bolt circle
- 44 mm offset
- 160 mm backspacing



NOTE: Will not work with OEM Mustang Brembo® brakes.

MUSTANG - 2014-EARLIER (CONTINUED)
MUSTANG AND FOCUS TPMS SENSOR AND ACTIVATION TOOL KIT
M-1180-A

- Fits 2010-2014 Mustang V6 and Mustang GT
- Fits 2010-2012 Shelby GT500
- Fits 2013-2018 Focus ST
- Fits 2010-2018 Focus
- Kit contains 4 valve-mounted snap-in tire pressure monitor sensors (valve stem TPMS) and tire pressure monitor activation tool
- Mustang and Focus require that tire pressure monitor sensors are installed and properly activated. Failure to install and activate sensors will cause tire pressure monitor light to remain on
- Activation tool can be used to retrain sensors after tire rotation
- Warning: Requires wheels specifically designed for valve-mounted snap-in tire pressure monitor sensors



NOTE: Will NOT work on 2007-2009 Mustang V6, GT or GT500. Valve stems are not designed for speeds over 155 mph.

WARNING: Cancer www.P65Warnings.ca.gov

MUSTANG SHELBY GT500 18" X 9.5" WHEEL
M-1007-S1895*

- Fits 2005-2014 Mustang GT
- Fits 2011-2014 Mustang V6
- Fits 2007-2012 Shelby GT500
- Bright machined face with medium argent painted pockets
- Original equipment on the 2007-2009 Mustang GT500
- Includes M-1096-N SVT Center Cap
- Band TPMS compatible
- Fits 2005-2010 Mustang V6 equipped with M-2300-D Brake Kit
- Fits M-2300-S Brembo® Brake Kit
- 18" x 9.5" wide
- 5-lug, 114 mm (4.5") bolt circle
- 45 mm offset
- 180 mm backspacing



NOTE: Manufactured in batches; color may not match factory wheels.

NOTE: Wheel is not compatible with valve stem mount TPMS.

FORD PERFORMANCE LUG NUT KIT
M-1012-A

- Fits 2005-2014 Mustang and most other 1/4"-20 thread applications
- Steel nut with polished stainless steel cap – same as used with production Mustang
- 13/16" Hex; Conical seat 60 degree
- Sold as a package of 5



*For 2005-2010 vehicles with 16" wheels from the factory: Installing 17" x 8" wheels, use 4R3Z-3932-BA Steering Stop. Installing 18" x 8.5" or 18" x 9.5" wheels, use 6R3Z-3932-CA Steering Stop. For vehicles with 17" wheels from the factory: Installing 18" x 8.5" or 18" x 9.5" wheels, use 6R3Z-3932-CA Steering Stop. 2011-2014 Mustang may require steering stops. Call the Ford Performance Techline at (800)367-3788 for more information.

TECH TIPS
WHEEL CLEANING TIPS
EXTERIOR CHROME CLEANING PROCEDURES

Wash the vehicle first, using cool or lukewarm water and a neutral pH shampoo, such as Motorcraft® Detail Wash (ZC-3-A).

Use Custom Brite Metal Cleaner (ZC-15), available from your authorized dealer. Apply the product as you would a wax to clean bumpers and other chrome parts; allow the cleaner to dry for a few minutes and then wipe off the haze with a clean, dry rag.

ALUMINUM WHEELS AND WHEEL COVERS CLEANING PROCEDURES

Aluminum wheels and wheel covers are coated with a clearcoat paint finish. To maintain their shine:

Clean weekly with Motorcraft® Wheel and Tire Cleaner (ZC-37-A) available from your authorized dealer. Heavy dirt and brake dust accumulation may require agitation with a sponge. Rinse thoroughly with a strong stream of water.

Never apply any cleaning chemical to hot or warm wheel rims or covers.

Some automatic car washes may cause damage to the finish on your wheel rims or covers. Chemical-strength cleaners, or cleaning chemicals, in combination with brush agitation to remove brake dust and dirt, could wear away the clearcoat finish over time.

Do not use hydrofluoric acid-based or high caustic-based wheel cleaners, steel wool, fuels or strong household detergent.

To remove tar and grease, use Motorcraft® Bug and Tar Remover (ZC-42), available from your authorized dealer. ■



FORD PERFORMANCE WHEELS AND CENTER CAPS

WHEEL PART NUMBER	VEHICLE APPLICATION	CENTER CAPS									
		M-1096-Q	M-1096-O	M-1096-A	M-1096-K	M-1096-FR	M-1096-FR1	M-1096-FP3	M-1096-N	M-1096-RS	M-1096K-RA
M-1007-DC1910LGB	Mustang			X							
M-1007-DC199LGB	Mustang			X							
M-1007-DC1995MB	Mustang							X			
M-1007-DC1910MB	Mustang							X			
M-1007-DC19105MB	Mustang							X			
M-1007-DC1911MB	Mustang							X			
M-1007-FST1908MG	Focus							X			
M-1007-M188GB	Focus	X									
M-1007-M1995B	Mustang		O					X			
M-1007-M199B	Mustang		O					X			
M-1007-P2085MB	F-150										
M-1007-R198GB	Focus							O		X	
M-1007-RGR1785OR	Ranger										X
M-1007-S1895	Mustang			O	O				X		
M-1007-SA1995MB	Mustang					X					
M-1007K-SU2008EB	SuperDuty										
M-1007-P188MB	Mustang			O	O		X				

X = Included with Wheel Kit O = Optional for that Wheel Kit



MUSTANG BAR AND PONY WHEEL CAP
M-1096-A



FORD PERFORMANCE WHEEL CENTER CAP
M-1096-FP3



FORD RACING CENTER CAP
M-1096-FR



2005-2014 FORD RACING WHEEL CENTER CAP
M-1096-FR1



FORD PERFORMANCE MUSTANG TRI-BAR CENTER CAP
M-1096-K



FORD PERFORMANCE SVT CENTER CAP
M-1096-N



2015-2019 MUSTANG WHEEL CENTER CAP PONY EMBLEM
M-1096-O



2012-2018 FOCUS WHEEL CENTER CAP
M-1096-Q



2016-2018 MK3 FOCUS RS CENTER CAP
M-1096-RS



2017-2019 RAPTOR/RANGER WHEEL CENTER CAP SET
M-1096K-RA



FORD FOCUS FIESTA TAURUS SHO



2013-2018 FOCUS ST/RS/MUSTANG ECOBOOST® COLD SPARK PLUG SET

M-12405-20T

- Fits 2013-2018 Focus ST 2.0L 4-cylinder EcoBoost® engine
- Fits 2016-2018 Focus RS 2.3L 4-cylinder EcoBoost® engine
- Fits 2015-2019 Mustang 4-cylinder EcoBoost® engine
- For use in engines with higher than stock cylinder combustion pressures
- Two heat ranges colder than the stock 2.0L/2.3L EcoBoost® engine spark plug
- Same spark plugs that are included with M-9603A-FSTA Performance Calibration Kit
- Sold in engine sets of 4
- Spark plugs gapped to 0.028" (0.71 mm)



2013-2018 FOCUS ST COLD AIR INTAKE KIT

M-9603-FST

- Fits 2013-2018 Ford Focus ST with 2.0L EcoBoost® I4 engine
- Kit includes new drop-in high-flow air filter and Ford Performance air inlet
- Complete with everything you need for installation
- CAD designed
- Lowers air inlet temperatures, which reduces turbo outlet temperatures, in turn increasing torque output



WARNING: Cancer www.P65Warnings.ca.gov

2013-2018 FOCUS ST CALIBRATION AND SPARK PLUGS

M-14204-FSTA*

- Fits 2013-2018 Focus ST with 2.0L EcoBoost® I4 engine
- Maximum of 90 lb-ft torque increase at 2800 rpm on 93 octane fuel
- Significant torque increase up to 4200 rpm
- Revised sound symposer software and calibration for more natural engine sound
- Premium (91 octane or higher) fuel only



Kit includes:

- Ford Performance Focus ST calibration with ProCal3 (requires laptop and internet access, not included)
- Ford Performance M-12405-20T Cold Spark Plug Set for 2.0L EcoBoost® (required with calibration)

NOTE: Powertrain calibrations are developed and supported for U.S. and Canadian vehicles only. Unlike many of our competitors, this Ford Performance calibration is 50-state emissions legal and eligible for limited warranty when installed by a Ford or Lincoln dealer or ASE certified technician. See the Ford Performance Warranty section for more information. Federal and state laws prohibit any person from installing aftermarket add-on or modified parts prior to the sale of a new motor vehicle. Spark plugs gapped to 0.028" (0.71 mm).

*This component is eligible for the Ford Performance Parts Limited Warranty. See the Ford Performance Parts Limited Warranty on pages 217-225 for details.

2013-2018 FOCUS ST CALIBRATION, SPARK PLUGS AND COLD AIR INTAKE

M-9603A-FSTA*



- Fits 2013-2018 Focus ST with 2.0L EcoBoost® I4 engine
- Maximum of 90 lb-ft torque increase at 2800 rpm on 93 octane fuel
- Significant torque increase up to 4200 rpm
- Revised sound symposer software and calibration for more natural engine sound
- Premium (91 octane or higher) fuel only



Kit includes:

- Ford Performance Focus ST calibration with ProCal3 (requires laptop and internet access, not included) and M-14204-FSTA Spark Plug Kit
- 2013-2018 Focus ST M-9603-FST Cold Air Intake with high-flow K&N/ Ford Performance air filter

NOTE: Powertrain calibrations are developed and supported for U.S. and Canadian vehicles only. Unlike many of our competitors, this Ford Performance calibration is 50-state emissions legal and eligible for limited warranty when installed by a Ford or Lincoln dealer or ASE certified technician. See the Ford Performance Warranty section for more information. Federal and state laws prohibit any person from installing aftermarket add-on or modified parts prior to the sale of a new motor vehicle. Spark plugs gapped to 0.028" (0.71 mm).

WARNING: Cancer www.P65Warnings.ca.gov

2013-2018 FOCUS ST FR1 POWER UPGRADE PACK

M-FR1-FSTA*



- Fits 2013-2018 Focus ST with 2.0L EcoBoost® I4 engine
- Maximum of 90 lb-ft torque increase at 2800 rpm on 93 octane fuel
- Significant torque increase up to 4200 rpm
- Revised sound symposer software and calibration for more natural engine sound
- Premium (91 octane or higher) fuel only



Kit includes:

- Ford Performance Focus ST calibration with ProCal3 (requires laptop and internet access, not included) and Spark Plug Kit M-14204-FSTA
- 2013-2018 Focus ST Cold Air Intake M-9603A-FSTA with high-flow K&N/Ford Performance air filter
- Focus ST M-5200-FST Cat-back Exhaust System

NOTE: Powertrain calibrations are developed and supported for U.S. and Canadian vehicles only. Unlike many of our competitors, this Ford Performance calibration is 50-state emissions legal and eligible for limited warranty when installed by a Ford or Lincoln dealer or ASE certified technician. See the Ford Performance Warranty section for more information. Federal and state laws prohibit any person from installing aftermarket add-on or modified parts prior to the sale of a new motor vehicle. Spark plugs gapped to 0.028" (0.71 mm).

WARNING: Cancer www.P65Warnings.ca.gov

FOCUS, FIESTA, TAURUS SHO (CONTINUED)

2013-2018 FOCUS ST PERFORMANCE RS COLD AIR INTAKE BOX M-9603-FSTA

- Fits 2013-2018 Focus ST
- Fits 2016-2018 Focus RS
- Includes Focus RS open element air-box with a K&N high-flow air filter
- Cold air inlet allows better breathing for increased horsepower
- Easy installation



⚠ WARNING: Cancer www.P65Warnings.ca.gov

2016-2018 FOCUS RS PERFORMANCE TURBO RECIRCULATION VALVE M-TRV-FPRS

The Ford Performance Parts updated turbo recirculation valve (TRV) is a direct replacement for the OE component.

Machined from solid aluminum with a piston-type design (compared to the OE diaphragm), the more robust design and material are suitable for vehicles in an advanced state of tune.

A diaphragm-design recirculation valve could function less effectively when the pressure differential across the turbocharger compressor housing is increased above the original operating conditions. This can cause the valve to open prematurely, leading to possible turbocharger damage due to increased turbo shaft speed.

With increased boost pressure, compressor-out temperatures can exceed the safe operating limit of the OE valve. The Ford Performance Focus RS TRV is engineered to withstand much greater temperatures while maintaining performance, making it an essential upgrade for cars running increased boost pressure.

- Fits 2016-2018 Focus RS
- Mounts directly on OE turbocharger
- Easy installation
- Suitable for vehicles running increased boost pressure
- Higher safe operating temperature
- Superior piston-type design
- Hard anodized for durability



2013-2018 FOCUS ST CAT-BACK SPORT EXHAUST SYSTEM M-5200-FST*

- Fits 2013-2018 Focus ST
- Cat-back performance exhaust system
- Uniquely designed and tuned to provide optimum performance, a deep and throaty sound, durability and pure driving excitement



- Meets 95 decibel drive-by noise standard for aftermarket exhaust systems when installed on stock applications
- Manufactured in the USA from high-quality 304 stainless steel
- Features ultra-smooth mandrel bends, warp-free flanges and superior craftsmanship



2012-2018 FOCUS HATCHBACK AXLE BACK EXHAUST SYSTEM M-5230-FSH*



- Fits 2012-2018 Focus Hatchback manual and automatic transmission with PZEV evaporative emission
- 304 stainless steel muffler body construction with polished tips
- Deeper, throatier exhaust note
- 50-state drive-by noise legal
- Factory exhaust pipe requires cutting to install clamp-on Ford Performance exhaust



2012-2014 FOCUS HATCHBACK ST EXHAUST SYSTEM WITH REAR FASCIA M-5230-FSHA

- Fits 2012-2014 base Focus Hatchback
- Meets 95 decibel drive-by noise standard for aftermarket exhaust systems when installed on stock applications
- Original equipment on 2013 Focus ST
- Includes unpainted Focus ST rear lower fascia, brackets, reflectors, inserts and installation hardware
- Factory exhaust pipe requires cutting to install clamp-on Ford Performance exhaust
- 409 aluminized stainless steel corrosion-resistant muffler body construction with a polished 304 stainless steel tip



2016-2018 FOCUS RS ACTIVE CAT-BACK SPORT EXHAUST SYSTEM M-5200-FRS*



- Fits 2016-2018 Focus RS
- Uniquely designed and tuned to provide optimum performance, aggressive sound, durability and pure driving excitement
- Retains the factory active exhaust control with a 2.5" NPP valve
- Manufactured in the USA from high-quality 304 stainless steel
- Features 3" exhaust pipe with ultra-smooth mandrel bends, warp-free flanges and superior craftsmanship
- Dual rear exit with 4" chrome-plated stainless steel exhaust tips with embossed "Ford" logo



2010-2018 TAURUS SHO CAT-BACK TOURING EXHAUST SYSTEM

M-5200-SHOTC*



This cat-back exhaust system bolts directly to the stock factory catalytic converters, making your Taurus SHO 100% emission compliant while providing an aggressive muscle car sound. The tuned stainless steel mufflers with 4" chrome-plated stainless steel tips not only sound great but look great too.

- Fits 2010-2018 Taurus SHO
- Uniquely designed and tuned to provide optimum performance, aggressive sound, durability and pure driving excitement
- Meets 95 decibel drive-by noise standard for aftermarket exhaust systems when installed on stock applications
- Manufactured in the USA from high-quality 304 stainless steel
- Features ultra-smooth mandrel bends, warp-free flanges and superior craftsmanship
- Bolts to stock catalytic converter
- 2.25" stainless steel cat-back tubing
- 4" chrome-plated stainless steel tips
- Uses stock hangers and mounts



2012-2014 FOCUS 5-SPEED SHORT THROW SHIFTER

M-7210-FS



- Fits 2012-2014 Ford Focus with 5-speed manual transmission
- 30% shorter shift throws than OEM shifter
- Nickel-plated shift handle resists corrosion



2013-2018 FOCUS ST SHORT THROW SHIFTER

M-7210-FST*

- Fits 2013-2018 Focus ST
- Reduces shifter throw by 18% over factory shifter

NOTE: 2015-2018 Focus ST requires the original shift boot to be installed onto the short throw shifter assembly.



FOCUS ST SHIFT KNOB - CARBON FIBER, BLACK, 6 SPEED

M-7213-FSTCF

Accent the interior of your Focus ST with arresting 6-speed action. Add some exotic high-performance-inspired radiance: This glossy spherical shift knob features the bright "ST" logo and authentic carbon fiber – an exceptionally strong material with an extremely attractive crystalline structure – that's weave patterned.



It's a precise fit and the perfect complement to the matching carbon-fiber emergency brake handle, instrument cluster bezel trim and front door spears available from Ford Accessories.

- Easy do-it-yourself installation

2016-2018 FOCUS RS SHORT THROW SHIFTER

M-7210-FRS*

- Fits 2016-2018 Focus RS
- Reduces shifter throw by 10% over factory shifter
- One of our most popular parts for Focus RS



2016-2018 FOCUS RS DRIFT STICK

M-2780-FRS

- Fits 2016-2018 Focus RS
- World's first electronically controlled performance drift stick
- Developed and fully tested by the Ford Performance vehicle and parts teams
- Inspired by rally racing, the Ford Performance drift stick provides a way to perform large-angle drifts in the Focus RS



- Simple bolt-in/plug-and-play installation and removal. Connects to the hand brake, seat track, and OBD-II port on the vehicle
- Uses the AWD and ABS systems to open the rear-drive unit clutches and apply hydraulic pressure to lock the rear wheels, inducing drift with a simple pull of the lever. Results in clutch-free drift turns similar to those in a real rally car
- This kit requires laptop and internet access for calibration install
- Available for LHD North America vehicles only
- For off-road use only

WARNING: This part has been designed and is intended for off-road use only (closed course and track events). This part should be removed for on-road vehicle use (minimum: disconnect strut and electrical connection). The driver is always responsible to drive in accordance with local laws and prevailing conditions. Failure to do so could result in accident or injury.

*This component is eligible for the Ford Performance Parts Limited Warranty. See the Ford Performance Parts Limited Warranty on pages 217-225 for details.

FOCUS, FIESTA, TAURUS SHO (CONTINUED)

2000-2005 SVT FOCUS STRUT/SHOCK KIT
M-18000-ZX3

- Fits 2000-2005 Focus models except wagon
- Focus SVT strut/shock kit improves handling over OEM Focus strut/shock
- Includes front struts with strut mount, spring seats and rear shocks

NOTE: Some factory fasteners are one-time use. Please reference service manual for reuse information and correct torque specifications. May require alignment after installation.



2006-2007 FOCUS PERFORMANCE SHOCK/STRUT KIT
M-18000-ZX3B

- Fits 2006-2007 Focus except wagon
- Improves handling over OEM Focus struts/shocks
- Includes front struts with mounts, spring seats and rear shocks



NOTE: Some factory fasteners are one-time use. Please reference service manual for reuse information and correct torque specifications. May require alignment after installation.

2000-2005 FOCUS SUSPENSION KIT
M-3000-ZX3

- Fits 2000-2005 ZX3, ZX4 and ZX5 Focus
- Original equipment on Focus SVT
- Upgrades your stock Focus suspension to Focus SVT suspension
- Improved handling characteristics without ride degradation
- Reduced ride height approximately .5"

NOTE: Some factory fasteners are one-time use. Please reference service manual for reuse information and correct torque specifications. Requires alignment after installation.



2000-2005 FOCUS ASSEMBLED SUSPENSION KIT
M-3000-ZX3A

- Fits 2000-2005 ZX3, ZX4 and ZX5 Focus
- Pre-assembled front struts
- Original equipment on Focus SVT suspension
- Upgrades your stock Focus suspension to Focus SVT
- Improved handling characteristics without ride degradation
- Reduced ride height approximately .5"
- Front struts come assembled with upper strut mounts and springs installed
- Kit does not include front or rear sway bars



NOTE: Some factory fasteners are one-time use. Please reference service manual for reuse information and correct torque specifications. Requires alignment after installation.

2013-2018 FOCUS ST QUAIFE TORQUE BIASING DIFFERENTIAL INSTALLATION KIT
M-4026-FST

Installation kit needed to install a Quaife Torque Biasing Differential

- Fits 2013-2018 Focus ST with Quaife torque biasing differential

Kit includes:

- Differential bearings – Qty 2
- Ring gear bolts – Qty 10
- Axle seals – Qty 2
- Gasket maker – Qty 2
- Threadlock and sealer – Qty 2 (1 red, 1 blue)
- Installation instructions



WARNING: Cancer www.P65Warnings.ca.gov

2014-2018 FIESTA ST QUAIFE TORQUE BIASING DIFFERENTIAL INSTALLATION KIT
M-4026-FA

Installation kit needed to install a Quaife Torque Biasing Differential

- Fits 2014-2018 Fiesta ST with Quaife torque biasing differential

Kit includes:

- Differential bearings –Qty 2
- Ring gear bolts – Qty 10
- Axle seals – Qty 2
- Gasket maker – Qty 2
- Threadlock and sealer –Qty 2 (1 red, 1 blue)
- Installation instructions



WARNING: Cancer www.P65Warnings.ca.gov

2012-2013 FOCUS LOWERING SPRINGS M-5300-S

- 2012-2013 Focus – **Does not fit Focus ST**
- Improves handling and stance
- Lowers vehicle approximately .3"-.6"
- Includes attachment hardware
- M-5300-S includes front and rear jounce bumpers
- May cause slightly harsher ride compared to stock springs



NOTE: Some factory fasteners are one-time use. Please reference a Ford service manual for reuse information and correct torque specifications. May require alignment after install.

2011-2018 FIESTA HANDLING PACK M-FR3-FA

- Fits 2011-2018 Fiesta Sedan and Hatchback
- Delivers improved handling characteristics without ride degradation
- Reduced ride height 12 mm-15 mm lower front
- Reduced ride height 22 mm-28 mm lower rear
- Includes front struts, front springs, rear shocks and rear springs

NOTE: Some factory fasteners are one-time use. Please reference service manual for reuse information and correct torque specifications. May require alignment after installation.



WARNING: Cancer www.P65Warnings.ca.gov

2013-2018 FOCUS ST FRONT BRAKE COOLING DEFLECTOR KIT M-2004-FRS

- Fits 2013-2018 Focus ST
- Fits 2016-2018 Focus RS
- Original equipment on the 2016-2018 Focus RS
- Used in the M-2300-W Focus ST Performance Front Brake Kit
- Brake air deflectors direct airflow to the front brakes to aid in brake cooling



Kit includes:

- Right front brake air cooling deflector
- Left front brake air cooling deflector
- Installation hardware and instructions

2013-2018 FOCUS ST PERFORMANCE FRONT RS BRAKE UPGRADE KIT M-2300-W

- Fits 2013-2018 Focus ST
- Original equipment on the 2016-2018 Focus RS
- Brembo® 4-piston calipers finished in RS Blue
- 13.7" (347 mm) vented RS brake rotors
- M-2300-WR Focus RS Rear Brake Kit available

Kit includes:

- RS Brembo® calipers
- Production RS brake rotors
- Production RS brake pads
- RS brake hoses
- M-2004-FRS RS Brake Air Deflector Kit
- All needed installation hardware

NOTE: Requires Ford Performance 2016 mk3 Focus RS M-1007-R198GB wheel or equivalent for caliper clearance.



2013-2018 FOCUS ST PERFORMANCE REAR RS BRAKE UPGRADE KIT M-2300-WR

- Fits 2013-2018 Focus ST
- Original equipment on the 2016-2018 Focus RS
- Rear calipers are finished in RS Blue
- Complements the M-2300-W Focus RS Front Brake Kit

Kit includes:

- RS rear calipers
- Production ST brake rotors
- Production RS brake pads
- Brake hoses
- All needed installation hardware



FOCUS, FIESTA, TAURUS SHO (CONTINUED)
FOCUS FORD PERFORMANCE WINDSHIELD BANNER
M-1820-FFP

- Fits 2012-2018 Focus
- Die-cut white lettering that will adhere to a properly prepared windshield
- 2" tall "FORD PERFORMANCE" script

FORD PERFORMANCE

2015-2018 FOCUS ST PERFORMANCE RS STEERING WHEEL KIT
M-3600-FRS

- Fits 2015-2018 Focus ST
- Fits 2016-2018 Focus RS
- Steering wheel includes unique Focus RS branding and blue stitching
- Kit contains a heated 2016 Focus RS steering wheel and all needed installation hardware



- Steering wheel works with factory heated and non-heated steering wheel equipped cars

NOTE: Heated steering wheel will not function when installed onto cars that are not equipped with the heated steering wheel option.

2016-2018 FOCUS RS REAR SPOILER KIT
M-5844210-RS

Install one of the most in demand Focus RS parts on your Focus with the Ford Performance Parts Focus RS rear spoiler kit.

- Fits 2013-2018 Focus ST
 - Fits 2016-2018 Focus RS
 - Fits 2012-2018 Focus Hatch
 - Distinct RS look
 - Easy installation
- Kit includes:**
- 2016-2018 Focus RS shadow black rear spoiler
 - High-mounted stop-lamp assembly
 - All needed attachment hardware
 - Installation instructions

2012-2018 FOCUS ST 18" X 8" WHEEL SET WITH TPMS KIT – GLOSS BLACK
M-1007K-M188GB

- Fits 2013-2018 Focus ST
- Fits 2012-2018 Focus
- Focus ST cast aluminum wheel with gloss black finish, clearcoated to OEM standards
- Includes M-1180-A TPMS Sensor and Activation Tool Kit
- Includes M-1096-Q Ford "Blue Oval" Center Cap
- 18" x 8" wide
- 5-lug, 108 mm bolt circle
- 55 mm offset
- 169.5 mm backspacing



WARNING: Cancer www.P65Warnings.ca.gov

2012-2018 FOCUS WHEEL CENTER CAP
M-1096-Q

- Fits 2012-2018 Ford Performance Parts Focus 18" and 19" wheels
- Chrome "Ford" logo on a blue background
- Comes standard on Ford Performance Parts 2012-2015 18" and 19" Focus wheels M-1007-M188GB, M-1007-PF188MB, M-1007-R1985, M-1007-R1985B, and M-1007-R1985W

2012-2018 FOCUS ST 18" X 8" WHEEL – GLOSS BLACK
M-1007-M188GB

- Fits 2013-2018 Focus ST
- Fits 2012-2018 Focus
- Focus ST cast aluminum wheel with gloss black finish, clearcoated to OEM standards
- Includes M-1096-Q Ford "Blue Oval" Center Cap
- Valve stem TPMS compatible
- 18" x 8" wide
- 5-lug, 108 mm bolt circle
- 55 mm offset
- 169.5 mm backspacing

2016-2018 MK3 FOCUS RS 19" X 8" WHEEL – GLOSS BLACK
M-1007-R198GB

- Fits 2013-2018 Focus ST
- Fits 2016-2018 mk3 Focus RS
- Fits 2012-2018 Focus Hatchback
- 19" x 8" wide
- Gloss black paint finished to OEM standards
- Valve stem is TPMS compatible
- 5-lug, 108 mm bolt circle
- 50 mm offset
- 160 mm backspacing
- Includes M-1096-RS Ford Performance "RS" Center Cap



MK2 FOCUS RS WHEEL LUG NUT KIT
M-1012-RSA

Only use the Ford Performance mk2 Focus RS lug nuts with Ford Performance mk2 RS wheels. The mk2 RS wheel is NOT compatible with the standard North American lug nuts that came on your Focus. Use of other lug nuts may result in the wheel coming loose from the hub and loss of vehicle control resulting in potential injury or death. You must retain the original equipment lug nuts for use with original wheels and/or spare tire where applicable.

- Fits 2012-2016 Focus with Ford Performance mk2 RS wheels M-1007-R1985, M-1007-R1985B and M-1007-R1985W only!
- M12 x 1.5
- Sold in pack of 5



2016-2018 MK3 FOCUS RS CENTER CAP
M-1096-RS

- Fits 2016-2018 Focus RS
- Set yourself apart from other RS owners with this subtle change
- Replaces the stock "Ford" logo center caps found on Focus RS
- Included with Ford Performance M-1007-R198GB mk3 Focus RS Wheel



NEW 2013-2018 FOCUS ST 19" X 8" MATTE GRAY WHEEL

- M-1007-FST1908MG** Wheel Without TPMS Kit
- M-1007K-FST1908MG** Four-Wheel Set with TPMS Kit

Focus ST 10-spoke flow formed lightweight wheel. Developed in Germany exclusively by Ford Performance Parts.

- Fits 2013-2018 Focus ST
- Fits 2012-2018 Focus
- Premium paint (magnetic matte) with "Ford Performance" lettering (decal) located on the rim between the spokes opposite the valve stem
- Includes M-1096-FP3 Ford Performance Wheel Center Cap
- Valve stem TPMS compatible
- Kit (M-1007K-FST1908MG) includes M-1180-A TPMS Sensor and Activation Tool Kit
- 19" x 8" wide – recommended tire size 235/35R19
- 5-lug, 108 mm bolt circle
- 55 mm offset

NOTE: While the "Ford Performance" decal is under a matte clear coat, it is susceptible to damage from harsh chemicals, abrasives/scrubbing, automated car wash equipment, pressure washing and other improper care. Refer to your vehicle Owner's Manual for wheel cleaning recommendations.





FORD TRUCKS



2013-2016 F-150 3.5L TWIN TURBO UPGRADE KIT M-9438-35TA

- Fits 2013-2016 F-150 3.5L EcoBoost® engine
- Complete replacement turbochargers that fit in the stock location and deliver added power and torque
- Requires custom calibration to take full advantage of the improved power
- For off-road use only

Kit includes:

- New, larger Borg Warner® left and right turbochargers
- Exhaust adapters
- Turbocharger heat shields
- O-rings, gaskets and fasteners



2015-2016 6.7L DIESEL TURBO KIT M-TURBO-67

Replacement 2015-2016 turbo and hardware for 6.7L diesel. Higher performance capability than pre-2015 turbos.

Kit includes:

- Turbocharger assembly
- Lower intake manifold
- Exhaust heatshield
- EGR inlet tube
- Turbo outlet clamps
- Exhaust outlet tubes (RH & LH)
- Intake shields
- Turbo oil line
- All gaskets, including EGR
- All fasteners, spacers and studs



NOTE: Use on model years other than 2015-2016, not validated by Ford Performance. Calibration not included.

F-150 3.5L ECOBOOST® TURBOCHARGER UPGRADE KIT M-9438-35T

- F-150 3.5L EcoBoost® turbo upgrade includes all-new Borg-Warner® OEM turbochargers with an optimized compressor wheel that improves engine performance with the factory calibration.
- Fits 2011-2012 F-150 with the 3.5L EcoBoost® engine
- For off-road use only

Kit includes:

- Left and right turbochargers with optimized compressor wheel
- New attaching hardware – gaskets, fasteners, heat shields



6.7L DIESEL INJECTOR NOZZLE AND PUMP KIT M-9546-67



Original equipment on 2015-2016 6.7L diesel engine. Higher flow than prior model injectors.

Kit includes:

- FC3Z-9A543-A Injection Pump
- FC3Z-9H529-A Left Bank Nozzles and Feed Lines
- FC3Z-9H529-B Right Bank Nozzles and Feed Lines

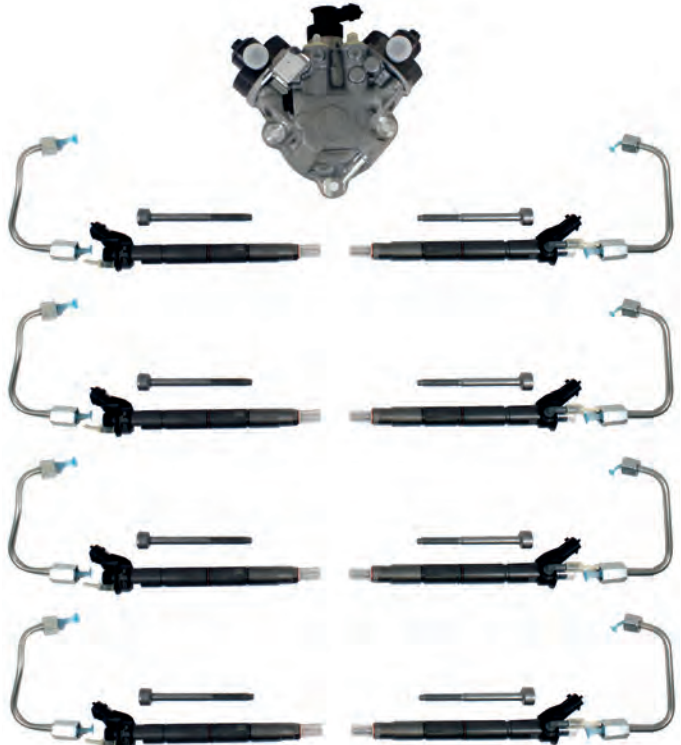

WARNING: Cancer www.P65Warnings.ca.gov



2015-2019 FORD PERFORMANCE F-150 CAT-BACK EXHAUST SYSTEMS*

Refer to chart for part numbers and tip style availability

2015-2019 F-150 Ford Performance by Borla® cat-back exhaust systems are available for 2.7L EcoBoost®, 3.5L EcoBoost® and 5.0L powered trucks and are manufactured in the USA using high-quality mandrel-bent 304 stainless steel tubing.

These systems offer easy installation and are available in three sound levels with options for side exit or rear exit chrome, black chrome or carbon fiber tips.

- Fits 2015-2019 Regular Cab, SuperCab and Crew Cab F-150 with 141", 145", 157" & 163" wheelbase
- 157" and 163" wheelbase trucks require an additional mid-pipe listed below
- Available in both dual right-side exit or dual split rear exit models
- Uniquely designed and tuned to provide optimum performance, aggressive sound, durability and pure driving excitement!



Side-Exit Exhaust – M-5200-F1535RSBA shown



Rear-Exit Exhaust – M-5200-F1535DSBA shown

2015-2019 F-150 SIDE-EXIT EXHAUST SYSTEMS			
2.7L ENGINE	Touring	Sport	Extreme
Chrome Tips	M-5200-F1527RTCA	M-5200-F1527RSCA	M-5200-F1527RECA
Black Chrome Tips	M-5200-F1527RTBA	M-5200-F1527RSBA	M-5200-F1527REBA
3.5L ENGINE			
Chrome Tips	M-5200-F1535RTCA	M-5200-F1535RSCA	M-5200-F1535RECA
Black Chrome Tips	M-5200-F1535RTBA	M-5200-F1535RSBA	M-5200-F1535REBA
5.0L ENGINE			
Chrome Tips	M-5200-F1550RTCA	M-5200-F1550RSCA	M-5200-F1550RECA
Black Chrome Tips	M-5200-F1550RTBA	M-5200-F1550RSBA	M-5200-F1550REBA



Carbon Fiber, Chrome and Black Chrome Tips

SOUND LEVEL OPTIONS:

- **TOURING** – Deeper tone than stock. Meets 95 decibel drive-by noise standard for aftermarket exhaust systems when installed in stock applications
- **SPORT** – Deeper tone with increased volume over stock
- **EXTREME** – Our most aggressive exhaust sound yet!

TIP STYLES AVAILABLE:

- 4" Rolled-edge chrome plated stainless steel
- 4" Rolled-edge black chrome plated stainless steel
- 4" carbon fiber

All systems bolt to stock catalytic converters, are approximately 30 lbs lighter than the factory cat-back system and use stock hangers and mounts.

APPLICATION NOTES:

- 141" wheelbase trucks require shortening the mid-pipe. Please refer to installation instructions
- 157" wheelbase requires M-5248-F15157A Mid-pipe
- 163" wheelbase requires M-5248-F15163A Mid-pipe

Please see our website (performanceparts.ford.com) for additional information on these exhaust systems and systems for other applications.

2015-2019 F-150 REAR-EXIT EXHAUST SYSTEMS			
2.7L ENGINE	Touring	Sport	Extreme
Chrome Tips	M-5200-F1527DTCA	M-5200-F1527DSCA	M-5200-F1527DECA
Black Chrome Tips	M-5200-F1527DTBA	M-5200-F1527DSBA	M-5200-F1527DEBA
Carbon Fiber Tips	M-5200-F1527DTFA	M-5200-F1527DSFA	M-5200-F1527DEFA
3.5L ENGINE			
Chrome Tips	M-5200-F1535DTCA	M-5200-F1535DSCA	M-5200-F1535DECA
Black Chrome Tips	M-5200-F1535DTBA	M-5200-F1535DSBA	M-5200-F1535DEBA
Carbon Fiber Tips	M-5200-F1535DTFA	M-5200-F1535DSFA	M-5200-F1535DEFA
5.0L ENGINE			
Chrome Tips	M-5200-F1550DTCA	M-5200-F1550DSCA	M-5200-F1550DECA
Black Chrome Tips	M-5200-F1550DTBA	M-5200-F1550DSBA	M-5200-F1550DEBA
Carbon Fiber Tips	M-5200-F1550DTFA	M-5200-F1550DSFA	M-5200-F1550DEFA

2017-2019 FORD PERFORMANCE RAPTOR 3.5L CAT-BACK EXHAUST SYSTEMS*

Refer to chart for part numbers and tip style availability



This Raptor exhaust system has been designed by Ford Performance engineers working with Borla® Industries. It includes unique Ford Performance technology that is not used in other aftermarket systems. This design provides optimum performance and premium durability while eliminating the low-end (1100-1900 rpm) cabin drone that is inherent in some other aftermarket systems.



M-5200-F15RSB shown above

2017-2019 RAPTOR 3.5L CAT-BACK EXHAUST SYSTEMS		
3.5L ENGINE	Touring	Sport
Chrome Tips	M-5200-F15RTC	M-5200-F15RSC
Black Chrome Tips	M-5200-F15RTB	M-5200-F15RSB
Carbon Fiber Tips	M-5200-F15RTCF	M-5200-F15RSCF
Mid-Pipe for 133" WB	M-5248-F15R133	



Carbon Fiber, Chrome and Black Chrome Tips

TOURING SYSTEM FEATURES

- Fits 2017-2019 F-150 Raptor with a 145" wheelbase. 133" wheelbase trucks require an additional mid-pipe listed below
- Uniquely designed and tuned with two 3" passive exhaust valves to provide optimum performance, a deep and throaty sound, durability and pure driving excitement
- Meets 95 decibel drive-by noise standard for aftermarket exhaust systems when installed on stock applications
- Manufactured in the USA from high-quality 304 stainless steel
- Features 2.75" exhaust pipe with ultra-smooth mandrel bends, warp-free flanges and superior craftsmanship
- Dual rear exit with 4.5" exhaust tips with embossed "Ford" logo
- Does not require removal of spare tire

NOTE: 133" wheelbase Raptor requires M-5248-F15R133 Mid-Pipe.

SPORT SYSTEM FEATURES

- Fits 2017-2019 F-150 Raptor with a 145" wheelbase. 133" wheelbase trucks require an additional mid-pipe listed below.
- Uniquely designed and tuned with one 3" passive exhaust valve to provide optimum performance, aggressive sound, durability and pure driving excitement
- Manufactured in the USA from high-quality 304 stainless steel
- Features 2.75" exhaust pipe with ultra-smooth mandrel bends, warp-free flanges and superior craftsmanship
- Dual rear exit with 4.5" exhaust tips with embossed "Ford" logo
- Does not require removal of spare tire

NOTE: 133" wheelbase Raptor requires M-5248-F15R133 Mid-Pipe.

*This component is eligible for the Ford Performance Parts Limited Warranty. See the Ford Performance Parts Limited Warranty on pages 217-225 for details.



2011-2014 FORD PERFORMANCE F-150 CAT-BACK EXHAUST SYSTEMS*

For F-150, F-150 Raptor and F-150 Tremor Models – refer to chart for details

Ford Performance has partnered with industry-leader Borla® Exhaust to offer the Ford Performance by Borla® exhaust systems. Constructed from ultra-smooth mandrel bent 300-series stainless steel tubing, these cat-back systems are designed to Ford Performance specs and give your truck an aggressive sound. These cat-back exhaust systems bolt directly to the stock factory catalytic converters, making your F-150 100% emission compliant. These tuned stainless steel mufflers with chrome-plated stainless steel tips not only sound great but look great too.



2011-2014 F-150 Cat-Back Exhaust System – Rear Exit, Chrome Tips



2014 F-150 Tremor 3.5L Cat-Back Sport Exhaust System – Side Exit, Black Chrome Tips

2011-2014 F-150 CAT-BACK EXHAUST SYSTEMS FOR 145" WHEELBASE

	Rear-Exit Touring	Rear-Exit Sport	Side-Exit Tremor	Side-Exit Touring Raptor	Side-Exit Sport Raptor
3.5L ECOBOOST® ENGINE	N/A	M-5200-F1535145L	N/A	N/A	N/A
5.0L COYOTE ENGINE	M-5200-F1550145C	M-5200-F1550145L	N/A	N/A	N/A
6.2L RAPTOR ENGINE	N/A	N/A	N/A	M-5200-F15R145C	M-5200-F15R145L
2014 TREMOR 3.5L ECOBOOST®	N/A	N/A	M-5200-F1535126L	N/A	N/A

MID-PIPES REQUIRED FOR ALTERNATE WHEELBASES

For 126" Wheelbase	M-5248-F15126C	M-5248-F15126L	N/A	N/A	N/A
For 133" Wheelbase	M-5248-F15133C	M-5248-F15157L	N/A	N/A	N/A
For 157" Wheelbase	M-5248-F15157C	M-5248-F15163L	N/A	N/A	N/A
For 163" Wheelbase	M-5248-F15163C	M-5248-F15133L	N/A	N/A	N/A
Raptor 133" Wheelbase	N/A	N/A	N/A	M-5248-F15R133C	M-5248-F15R133L

TOURING SYSTEM FEATURES

- Fits 2011-2014 F-150 5.0L Coyote and Raptor 6.2L engines with 145" wheelbase
- 50-state legal for drive-by noise
- Uniquely designed and tuned to provide optimum performance, aggressive sound, durability and pure driving excitement
- Made from high-quality 304 stainless steel
- Dual rear exit with 304 stainless steel chrome-plated "Ford Oval" embossed 4" round exhaust tips
- Features ultra-smooth mandrel bends, warp-free flanges and superior craftsmanship
- Does not require removal of spare tire

SPORT SYSTEM FEATURES

- Available for 2011-2014 F-150 5.0L Coyote or 3.5L EcoBoost® engines and Raptor 6.2L with 145" wheelbase
- 49-state legal for drive-by noise. Louder than touring exhaust system
- Uniquely designed and tuned to provide optimum performance, aggressive sound, durability and pure driving excitement
- Made from high-quality 304 stainless steel
- Dual rear exit with 304 stainless steel chrome-plated "Ford Oval" embossed 4" round exhaust tips
- Features ultra-smooth mandrel bends, warp-free flanges and superior craftsmanship
- Does not require removal of spare tire

2016-2019 F-SERIES CARBON FIBER SHIFT HANDLE M-7213-F15CF

Add some Raptor style to your F-150 with the Carbon Fiber Shift Handle. Fitting any F-150 with a console shift handle, this carbon fiber version is similar to the handle included in 2017-2019 F-150 Raptors equipped with the optional, Carbon Fiber Package.



- Carbon Fiber shift handle inspired by the F-150 Raptor Carbon Fiber Package
- Fits 2016-2019 F-150 with console shifter and Drive Mode switch

2004-2014 F-150 REAR LOWERING KIT M-3000-G

- Fits 2004-2014 F-150
- Designed to lower the rear of your truck without sacrificing the factory ride quality
- Reduces rear ride height approximately 2.0" on a 2WD or 1.5" on a 4WD, giving you more of that leveled, sport truck stance you want
- Kit includes lowering shackles, pinion shims and installation hardware



2015-2019 F-150 COMPLETE LOWERING KIT M-3000-H4A

- Fits 2015-2019 F-150 2WD and 4WD SuperCab and SuperCrew
- Reduces front ride height approximately 1.5" and rear ride height approximately 2.5" to give you that lowered and level sport truck stance you want
- Kit includes precision tuned front coils, laser-cut steel lowering shackles with urethane bushings and laser-cut strut spacer for front height adjustability



2015-2019 F-150 REAR LOWERING KIT M-3000-HA

- Fits 2015-2019 F-150 4WD Regular Cab, SuperCab and SuperCrew
- Reduces rear ride height approximately 1.5", giving you more of that leveled, sport truck stance you want
- Kit includes laser cut steel lowering shackles with urethane bushings



NEW 2015-2019 F-150 FOX "TUNED BY FORD PERFORMANCE" OFF-ROAD LEVELING SUSPENSION KIT M-18000-F15A

Our Fox "Tuned by Ford Performance" 2.0 Performance Series IFP (Internal Floating Piston) front and rear shock kits are loaded with the advanced technology and features you'd expect from Fox and are then taken to the next level through tuning by Ford Performance engineers. These proprietary kits are designed and tested to optimize ride and performance both off- and on-road, making them the best solution for the most discriminating performance enthusiasts.

Features include:

- Fits 2015- 2019 F-150 4WD Models
- Levels truck front to rear
- Precision impact extruded aluminum bodies that increase cooling capacity and are rust resistant
- Front coil-overs feature top quality racing coils selected to deliver the optimal spring rate
- Improves front approach angle: 31° vs. 26° stock
- Improves breakover angle: 23° vs. 21° stock
- Vehicle-specific upper front mounts include a composite bushing that isolates noise and vibration
- Locking, spring preload rings allow easy front ride height and preload adjustments
- Provides a comfortable on-road ride and predictable off-road handling in even the toughest conditions
- Easy bolt-in installation with no other modifications required



8.8" FRONT AXLE LIMITED SLIP TORSEN® DIFFERENTIAL M-4204-F15OLS

- Fits 2004-2019 F-150 4x4 front axle
- 8.8" Torsen® differential
- 31 spline
- Features full-time torque sensing, torque biasing differential
- Standard on Raptor



*This component is eligible for the Ford Performance Parts Limited Warranty. See the Ford Performance Parts Limited Warranty on pages 217-225 for details.

SUPER DUTY® | F-150 | RAPTOR | RANGER (CONTINUED)

NEW 2017-2018 RAPTOR FOX FACTORY RACE SERIES 3.0 FRONT & REAR SUSPENSION UPGRADE KIT M-18000-F15R

Take your 2017-2018 Raptor to the next level with this complete Fox Factory Race Series 3.0 front and rear suspension upgrade kit from Ford Performance.

- The front shocks deliver a high level of adjustability via Dual Speed Compression (DSC) adjusters and improved cooling efficiency through an all-new Recirculating Reservoir Bridge and finned remote reservoir
- The adjustable front coil-over springs are pre-set to level your Raptor front-to-rear on installation
- The rear shocks include External Bypass position-sensitive damping, Quick Adjust Bypass (QAB), and an External Cooling System (ESC2)
- This kit delivers the next level of off-road performance without sacrificing everyday ride quality and comfort.

NOTE: The rear shocks may produce a slight clicking sound on jounce/rebound. This is normal and is not typically audible inside the cab of the vehicle.



8.8" 4X4 FRONT 4.10 RING GEAR AND PINION M-4209-88410F

Fits 2004-2019 F-150 4x4 front axle, including these models:

- Ford Expedition (1997-2014)
- Ford F-150 1/2 Ton (1997-2019)
- Ford F-150 Raptor Edition (2010-2014)
- Ford F-250 3/4 Ton (1997-1999)
- Lincoln Mark LT (2006-2008)
- Lincoln Navigator (1998-2014)
- 4.10 8.8" ring and pinion
- OEM quality – superior surface finish, hardening and manufacturing consistency



Kit includes:

- Crush collar
- Ring gear bolts
- Pinion seal
- Pinion nut
- Pinion bearing

2015-2018 F-150 RAPTOR PERFORMANCE STEERING WHEEL KIT- ORANGE SIGHTLINE M-3600-F15ROR

- Fits 2015-2018 F-150
- Fits 2017-2018 Raptor
- Original equipment on 2017-2018 Raptor with the Interior Color Accent Package (60R)
- Black leather construction with orange stitching and an orange leather sightline
- The Raptor steering wheel has a more aggressive look and defined feel than F-150 steering wheels
- Easy installation
- Steering wheel comes equipped with wire harness, trim bezel and Raptor steering wheel controls. Installation into a non-Raptor F-150 and Raptor equipped with the Technology Package (68R) requires the steering wheel controls to be swapped from the original steering wheel
- Steering wheel is a great addition to a 2017 Raptor that did not come with the Interior Color Accent Package (60R)
- Kit includes a 2017 Raptor orange sightline heated steering wheel and all needed installation hardware



NOTE: Heated steering wheel will not function when installed onto vehicles that are not equipped with the heated steering wheel option.

NOTE: Paddle shifters will not function when installed onto F-150 trucks that were not originally equipped with paddle shifters from the factory.

2015-2018 F-150 RAPTOR PERFORMANCE STEERING WHEEL KIT- RED SIGHTLINE M-3600-F15RRD

- Fits 2015-2018 F-150
- Fits 2017-2018 Raptor
- Original equipment on 2017-2018 Raptor without the Interior Color Accent Package (60R)
- Black leather construction with perforated sides, gray stitching and a red leather sightline
- The Raptor steering wheel has a more aggressive look and defined feel than F-150 steering wheels
- Easy installation
- Steering wheel comes equipped with a wire harness, trim bezel and Raptor steering wheel controls. Installation into a non-Raptor F-150 and Raptor equipped with the Technology Package (68R) requires the steering wheel controls to be swapped from the original steering wheel
- Kit includes a 2017 Raptor red sightline heated steering wheel and all needed installation hardware



NOTE: Heated steering wheel will not function when installed onto vehicles that are not equipped with the heated steering wheel option.

NOTE: Paddle shifters will not function when installed onto F-150 trucks that were not originally equipped with paddle shifters from the factory.

FORD PERFORMANCE BY WARN® INDUSTRIES OFF-ROAD RECOVERY KIT-HEAVY DUTY M-1820-FPORRH

Don't get stuck off-road without the essentials; this heavy duty Ford Performance by WARN® Industries recovery kit is designed to assist in the recovery of a vehicle stuck in mud, sand or snow. This comprehensive recovery kit is sure to complement your off-road adventure. For use with winches up to 12,000 lbs capacity.

Kit includes:

- "Ford Performance by WARN® Industries" storage bag/tote
- "Ford Performance," 3" x 30' blue recovery strap – rated to 21,600 lbs
- Tree trunk protector, 4" x 8' – rated to 30,000 lbs
- Heavy duty snatch block with greaseable port – for winch capacities up to 12,000 lbs
- "Ford" branded winching gloves – size XL
- WARN® Industries 3/4" D-shackles – rated to 18,000 lbs – 2
- Instruction manual



FORD PERFORMANCE BY WARN® INDUSTRIES OFF-ROAD RECOVERY KIT M-1830-FPORR

Don't get stuck off-road without the essentials; this Ford Performance by WARN® Industries recovery kit is designed to assist in the recovery of a vehicle stuck in mud, sand or snow. This comprehensive recovery kit is sure to complement your off-road adventure. For use with winches up to 10,000 lbs capacity.

Includes:

- "Ford Performance by WARN® Industries" storage bag
- "Ford Performance," 2" x 22' blue recovery strap – rated to 14,400 lbs
- "Ford" branded winching gloves – size XL
- WARN® Industries 3/4" D-shackle – rated to 18,000 lbs
- Instruction manual



2015-2019 F-150 "FORD PERFORMANCE" SILL PLATE SET M-1613208-F15A



- Fits 2015-2019 F-150 SuperCrew
- Original equipment on 2017-2018 F-150 Raptor SuperCrew
- Brushed metal "Ford Performance" logo
- Durable black ABS construction
- Easy installation
- Set includes both the right and left sill plate



RAPTOR/F-150 ROCK SLIDER SIDE STEPS

M-16450-F15RA SUPERCREW
M-16450-F15RAB SUPERCAB

The rock slider side steps look as good as they are tough! Built using 0.120" wall American steel, they help protect your truck from abuse, rocks and debris during spirited off-road adventures. They also double as an entry step with included LED lighting.



M-16450-F15RAB shown

- Fits 2015-2019 F-150 SuperCrew/ SuperCab and 2017-2019 Raptor SuperCrew/SuperCab
- Durable hammer black powdercoat finish with a satin black powdercoat finish on the step surface
- "Ford Performance" logo cutouts
- LED lighting below step
- Bolt-on installation
- Installation hardware included

2015-2019 RAPTOR /F-150 RACE SIDE STEPS

M-16450-F15RAC SUPERCREW
M-16450-F15RAD SUPERCAB

Raptor/F-150 race side steps are designed to be strong and lightweight. Constructed from the best materials, these steps tuck up close to your truck to provide a smart, distinctive look. They protect your truck from abuse while offering help getting in, with a dimpled-hole deck surface that provides non-slip footing.



M-16450-F15RAC shown

- White LED lighting under the step helps you find your way in the dark.
- Fits 2015-2019 F-150 SuperCrew/SuperCab and 2017-2019 Raptor SuperCrew/ SuperCab
- Durable hammer black powdercoat finish
- LED lighting below step
- Bolt-on installation – mounts to the factory step mounting locations
- Black oxide stainless steel installation hardware included
- "Ford Performance" logo cutouts

SUPER DUTY® | F-150 | RAPTOR | RANGER (CONTINUED)
2017-2019 RAPTOR/F-150 RACE SERIES REAR CHASE RACK WITH LIGHT BAR ACTUATOR M-19007-A

Designed to provide you with additional light mounting options during nighttime off-road adventures. This tough chase rack features a light actuator kit that allows raising and lowering a front-facing 50" LED light bar while on-the-go! Light mount tabs for rear-facing 3" cube lights offer options to light up the area behind your truck too. This great looking and functional chase rack will make your truck stand out in the crowd!

- Fits 2017-2019 Raptor SuperCrew and SuperCab models, and 2015-2019 F-150 SuperCrew and SuperCab models
- Light Actuator allows raising and lowering a 50" LED light bar on-the-go
- Accommodates one 50" LED Light Bar on the front and 3" rear-facing LED cube lights on each side
- Includes Ford Performance Logo Cut-outs
- Retains the factory High-Mount Stop Light
- Made from 0.120" wall steel tubing and 0.125" thick aluminum panels
- Mig Welded
- Finished using a durable 3-stage black powdercoated finish
- Bolt-on installation
- Black oxide stainless steel hardware and wire harness is included



NOTE: LED Lighting is not included

2017-2019 RAPTOR/F-150 CHASE RACK/ROOF RACK M-19007-B

Built tough and provides your truck with the rugged utility and extra space you want - all in one smart, great looking package! The chase rack bolts to the bed rails for solid and secure installation.

The roof rack section is built from 0.125" thick aluminum to keep weight down and includes two locking tool storage boxes at the rear for secure storage. It also includes mounts for dual 50" LED light bars on the front and multiple mounts for 3" square LEDs on each side.

- Fits 2017-2019 Raptor SuperCrew and SuperCab models and 2015-2019 F-150 SuperCrew and SuperCab models
- Two locking tool storage boxes
- Accommodates up to two 50" LED Light Bars on the front and three 3" LED cube lights on each side
- Includes rear facing 3rd brake light and Ford Performance Cut-outs
- Made from 0.135" thick steel and 0.125" thick aluminum panels
- Mig Welded
- Finished using a durable 3-stage black powder coated finish
- Bolt-on installation
- Black oxide stainless steel hardware and wire harness is included



NOTE: LED Lighting is not included

2017-2019 RAPTOR CHASE RACK IN-BED TIRE CARRIER M-19007-BC

Fits 2017-2019 Raptor equipped with Raptor Chase Rack M-19007-A

- The Ford Performance Raptor Chase Rack In-Bed Tire Carrier is an add-on unit designed to work with Raptor Chase Rack/Roof Rack M-19007-B.
- It allows for storing up to a 40" tire on an angle, leaving room for storage underneath.
- Made of high-quality American steel, it shares the same level of fit and finish as the chase rack and will set your truck apart in the crowd!

NEW 2017-2019 SUPER DUTY CHASE RACK M-19007-SD

The Ford Performance Super Duty Chase Rack adds style and functionality to your truck and is easy to install. The tough hammer black powdercoated steel rack bolts together and provides a great base for mounting your accessories. Brackets for mounting a 50" light bar are included. This great looking and functional chase rack will make your truck stand out in the crowd!

- Fits 2017-2019 Super Duty Pickups
- Accommodates 50" RIGID® LED Light Bar (or similar)
- Can be used with or without installation of included 50" LED Light Bar brackets
- Features Ford Performance Logo on side panels
- Retains the factory High-Mount Stop Light
- Finished using a durable 3-stage black powdercoated finish
- Bolt-on installation (no drilling)
- Black oxide stainless steel hardware

NOTES: LED Lighting/wiring is not included

NEW F-150 / RAPTOR CHASE RACK M-19007-F15R

The Ford Performance F-150 Chase Rack adds style and functionality to your truck and is easy to install. The tough hammer black powdercoated steel rack bolts together and provides a great base for mounting your accessories. Brackets for mounting a 50" light bar are included. This great looking and functional chase rack will make your truck stand out in the crowd!

- Fits 2015-2020 F-150 and 2017-2020 F-150 Raptor
- Accommodates 50" RIGID® LED Light Bar (or similar)
- Can be used with or without installation of included 50" LED Light Bar brackets
- Features Ford Performance Logo on side panels
- Retains the factory High-Mount Stop Light
- Finished using a durable 3-stage black powder coated finish
- Bolt-on installation (no drilling)
- Black oxide stainless steel hardware

NOTES: LED Lighting/wiring is not included



NEW 2017-2019 RAPTOR SAE LED FOG LIGHT KIT M-15200-RFL

Ford Performance worked with one of the most recognized names in Off-Road lighting, RIGID®, to develop this Off-Road Fog Light Kit which works exclusively on the 2017-2019 Raptor. The kit allows you to mount RIGID's D-Series LED lights in the openings of the Raptor front bumper.



- The kit includes two RIGID D-Series Flood, two D-Series SAE, and two D-Series Spot (three lights per side – six lights total), a unique harness, high quality, stainless steel mounting brackets, and six light covers (three per side) – everything needed for an easy installation.
- Kit includes two “Ford Performance” branded lens covers and four “RIGID” branded lens covers which provide protection to the lens of the lights, while offering an alternative appearance.

NOTE: This Off-Road Fog Light Kit works only with 2017-2019 Raptors

WARNING: This part has been designed and is intended for off-highway application only. Installation on a vehicle intended for use on public roads may violate U.S., Canadian, state or provincial laws and regulations including those relating to emission requirements and motor vehicle safety standards. In addition, installation of this part may adversely affect the warranty coverage on your vehicle.

2017-2019 F-150 RAPTOR SKID PLATE KIT M-5018-F15RB

Get the undercarriage protection you need for your new Raptor with the same skid plates that were used on the 2017 Ford Raptor race truck. The Ford Performance Skid Plate Kit protects the transmission and transfer case from undercarriage rock damage. Made from powdercoated 3/16" thick aluminum and designed to bolt on and fit the truck perfectly.

- Fits 2017-2019 F-150 Raptor
- Protects the transmission and transfer case from rock damage
- Made from 3/16 thick powder coated aluminum plate
- Laser-cut Ford Performance Logos on the main cover
- Easy bolt on installation
- Same skid plates that were used on the 2017 Raptor Best in The Desert race truck that competed in the Baja 1000 and The Mint 400

Kit includes the following:

- Front Cover that protects the front differential and steering area
- Main Cover that protects the transmission and transmission cross member
- Rear Cover that protects rear exposed section of transfer case
- All needed brackets, cross members and hardware

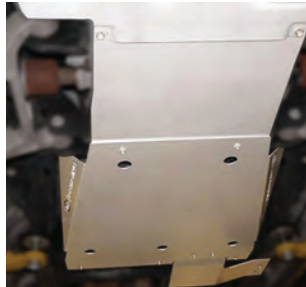

2015-2019 F-150 20" X 8.5" SIX SPOKE WHEEL – MATTE BLACK M-1007-P2085MB

- Fits 2015-2019 F-150
- Matte black paint finish, clearcoated to OEM standards
- Includes blue “Ford Oval” center cap
- Valve stem TPMS compatible
- Use with M-1180-B TPMS Sensor and Activation Tool Kit
- Also available as a four wheel set M-1007K-P20XB with a TPMS kit
- 20" x 8.5" wide
- 6-lug, 135 mm bolt circle
- 44 mm offset



- 160 mm backspacing

2017-2018 F-150 RAPTOR BEAD-LOCK WHEEL KIT M-1007-W1785B

- Fits 2017-2018 F-150 Raptor
- The bead-lock wheel kit includes everything needed to upgrade your base Raptor wheels to have performance off-road bead-locking capability
- Off-road proven in all of the 2016 Best in the Desert series racing events and in the 2016 Baja 1000
- Wheel is finished in a matte black paint finish, clearcoated to OEM standards
- 17" x 8.5" wide
- 6-lug, 135 mm bolt circle
- 34 mm offset
- 156.5 mm backspacing
- Use with M-1180-B TPMS Sensor and Tool Kit
- Shown with optional Ford Performance F-150 Lug Nut Kit, M-1012-FA



Kit includes:

- 17" forged aluminum bead-lock capable wheel
- Factory forged aluminum trim ring
- “Ford” center cap
- Ford Performance M-1021-F15RB Bead-Lock Ring Kit

NOTE: Bead-lock configuration is for off-road use only.

2015-2019 F-150 20" X 8.5" SIX SPOKE WHEEL SET WITH TPMS KIT – MATTE BLACK M-1007K-P20XB

- Fits 2015-2019 F-150
- Matte black paint finish, clearcoated to OEM standards
- Includes blue “Ford Oval” center caps
- Includes M-1180-B Sensor and Activation Tool Kit
- 6-lug, 135 mm bolt circle
- 44 mm offset
- 160 mm backspacing



WARNING: Cancer www.P65Warnings.ca.gov

2015-2019 F-150 LUG NUT KIT M-1012-FA

- Fits 2015-2019 F-150
- Fits 2017-2019 Raptor
- Fits M14 x 1.5 wheel stud
- Kit contains 6 lug nuts



NOTE: For use on alloy wheels only.

SUPER DUTY® | F-150 | RAPTOR | RANGER (CONTINUED)
NEW F-150 BLACK LUG NUT KIT
M-1012K-F15B

- Fits 2015-2019 F-150
- Fits 2019 Expedition and Navigator
- Ford Performance Parts Black Chrome Lug Nuts provide a unique look with a durable scratch and wear resistant OEM finish
- Fits M14 x 1.5 wheel stud
- Kit contains 24 Lug Nuts



NOTE: Hand installation and removal with non-marring lug nut sockets is strongly recommended to prevent surface damage to the black lug nuts.

NEW 2019 F-150 RAPTOR BEAD-LOCK WHEEL KIT
M-1007-DC1785A

- Fits: 2019 F-150 Raptor
- The Bead-Lock Wheel Kit includes everything needed to upgrade your base Raptor wheels to have performance off-road bead-locking capability
- Wheel and standard trim ring are finished in a magnetic grey paint finish, clear coated to OEM standards

Kit Includes:

- 17" Forged aluminum bead-lock capable wheel
- Factory forged aluminum trim ring
- Unique "FORD" Raptor center cap
- Ford Performance Bead-lock ring kit M-1021-RA1
- 17" x 8.5" wide
- 6-lug, 135 mm bolt circle
- 34 mm offset
- 156.5 mm backspacing
- Use with M-1180-B TPMS Sensor and Tool kit

NOTE: Bead-lock configuration is for off-road use only

2017-2018 RAPTOR BEAD LOCK WHEEL TRIM RING SETS

M-1021-F15BL Blue (set of 4)	M-1021-F15OR1 Orange (1 ring)
M-1021-F15BL1 Blue (1 ring)	M-1021-F15RD Red (set of 4)
M-1021-F15OR Orange (set of 4)	M-1021-F15RD1 Red (1 ring)

- Fits 2017-2018 Raptor with the factory bead-lock wheel option or Ford Performance Parts M-1007-W1785B Bead-Lock Wheel Kit
- Raptor bead-lock trim rings provide an easy way to customize your Raptor and give your bead-lock wheels a unique and awesome look!
- Forged aluminum and CNC machined
- Durable powdercoat finish
- Set includes four blue, orange or red powdercoated trim rings
- Easy installation

2013-2018 F-150 RAPTOR BEAD LOCK RING KIT

M-1021-F15RB	2017-2018
M-1021-F15RA	2013-2014

- Fits F-150 Raptor with factory bead-lock wheel option
- Includes forged aluminum bead-lock ring, 24 fasteners and mounting instructions
- Bead-lock configuration is for off-road use only

2019 RAPTOR BEAD LOCK RING KIT
M-1021-RA1

- Fits 2019 F-150 Raptor with factory bead-lock wheel option (64D)
- Includes forged aluminum bead-lock ring, 24 fasteners, and mounting instructions
- Bead-lock configuration is for off-road use only

NEW 2019 RANGER 2.3L FORD PERFORMANCE SPORT EXHAUST SYSTEM – SIDE EXIT TIPS

M-5200-RA23SB*	Dual Black-Chrome Tips
M-5200-RA23SC*	Dual Chrome Tips

- Fits 2019 Ranger 2.3L SuperCrew and SuperCab Models
- Ford Performance Ranger Sport exhaust systems are uniquely designed and tuned to provide an aggressive and throaty high performance sound that is sure to enhance your driving experience
- Features ultra-smooth mandrel bends, warp-free flanges and superior craftsmanship
- Dual side exit with black-chrome or bright chrome plated 4-inch stainless steel exhaust tips
- Manufactured in the USA from high quality 304 stainless steel
- System includes dual-exit Muffler, dual tailpipe assembly with welded-on tips and all clamps needed for installation
- Easy installation – uses existing exhaust hanger locations and hardware

M-5200-RA23SB shown
NEW RANGER FORD PERFORMANCE DIFFERENTIAL COVER KIT
M-4033-R

- Fits 2019 Ranger rear differential
- Rugged cast iron construction
- Ford Performance badge
- Rugged "hammered" finish powdercoat
- Includes new fasteners and gasket



NEW 2019 RANGER FOX "TUNED BY FORD PERFORMANCE" OFF-ROAD LEVELING SUSPENSION KIT M-18000-R

Our Fox "Tuned by Ford Performance" 2.0 Performance Series IFP (Internal Floating Piston) front and rear shock kits are loaded with the advanced technology and features you'd expect from Fox and are then taken to the next level through tuning by Ford Performance engineers. These proprietary kits are designed and tested to optimize ride and performance both off- and on-road, making them a great solution for the most discriminating performance enthusiasts.



Features include:

- Fits 2019 Ranger 4WD Models
- Levels truck front to rear
- Shocks feature precision impact extruded aluminum bodies that increase cooling capacity and are rust resistant
- Front coil-overs feature top quality racing coils selected to deliver the optimal spring rate
- Improves front approach angle: 34.8° vs. 28.7° stock
- Improves breakover angle: 23.8° vs. 21.5° stock
- Vehicle-specific upper front mounts include a composite bushing that isolates noise and vibration
- Locking, spring preload rings allow easy front ride height and preload adjustments
- Provides a comfortable on-road ride and predictable off-road handling in even the toughest conditions
- Easy bolt-in installation with no other modifications required

NEW 2019 RANGER OFF-ROAD FOG LIGHT KIT M-15200-RFOG

Ford Performance worked with one of the most recognized names in Off-Road lighting, RIGID® to develop this Off-Road Fog Light Kit which works exclusively on the 2019 Ranger.

The Kit allows you to change your factory fog light assemblies to use RIGID's D-Series Pro Spot LED lights in your Ranger's OEM fog light locations. This kit gives you everything you need to mount the lights for a clean, "from-the-factory" look. Made from high quality components, these complete assemblies are plug-and-play and completely reversible with no cutting or splicing. Utilizing factory modified bezels, stainless steel black powdercoated trim plates, and RIGID's D-Series lights and harness, these assemblies are sure to deliver an easy-to-install, high quality off-road light package.

- The kit includes the complete fog light assemblies for an easy installation
- Using a unique harness, this kit plugs into the factory fog light harness, allowing the use of the factory fog light switch
- Kit includes "Ford Performance" branded lens covers which provide protection to the lens of the lights, while offering an alternative appearance
- Assemblies come preassembled, ready to install and aim



NOTE: This Off-Road Fog Light Kit works only with 2019 Rangers with factory fog lights.

WARNING: This part has been designed and is intended for off-highway application only. Installation on a vehicle intended for use on public roads may violate U.S., Canadian, state or provincial laws and regulations including those relating to emission requirements and motor vehicle safety standards. In addition, installation of this part may adversely affect the warranty coverage on your vehicle.

*This component is eligible for the Ford Performance Parts Limited Warranty. See the Ford Performance Parts Limited Warranty on pages 217-225 for details.

NEW RANGER HOOD HINGE-MOUNTED OFF-ROAD LIGHT KIT M-15200-RHM

Ford Performance worked with one of the most recognized names in Off-Road lighting, RIGID®, to develop this hood hinge Off-Road Light Kit which works exclusively on the 2019 Ranger. The kit allows you to mount RIGID's D-SS-Series LED lights onto the Ranger's hood hinges, giving you two LED off-road lights at the base of the A-Pillars. The kit includes two RIGID D-SS-Series lights, two black powdercoated stainless steel brackets, a unique harness with toggle switch, and "Ford Performance" branded lens covers.

NOTE: This Off-Road Hood Hinge Light Kit works only with 2019 Rangers.

WARNING: This part has been designed and is intended for off-highway application only. Installation on a vehicle intended for use on public roads may violate U.S., Canadian, state or provincial laws and regulations including those relating to emission requirements and motor vehicle safety standards. In addition, installation of this part may adversely affect the warranty coverage on your vehicle.



NEW 2019 RANGER FORD PERFORMANCE CHASE RACK M-19007-R



Rack adds style and functionality to your truck and is easy to install. The tough hammer black powdercoated steel rack bolts together and provides a great base for mounting your accessories. Brackets for mounting a 40" light bar are included. This great looking and functional chase rack will make your truck stand out in the crowd!

- Fits 2019 Ranger SuperCrew and SuperCab models
- Accommodates Ford Performance M-15200K-R 40" RIGID® LED Light Bar (or similar)
- Can be used with or without installation of included 40" LED Light Bar brackets
- Features Ford Performance Logo on side panels
- Retains the factory High-Mount Stop Light
- Finished using a durable 3-stage black powdercoated finish
- Bolt-on installation (no drilling)
- Black oxide stainless steel hardware
- Recommended to use with Ford VKB3Z-99501A42-N Tonneau Cover. If alternative Tonneau Cover is selected, modification will be necessary

NOTES:

- LED Lighting/wiring is not included
- Installation on trucks equipped with a drop-in bedliner will require bedliner modifications



NEW 2019 RANGER OFF-ROAD BUMPER M-17757-R1F

Ford Performance teamed up with off-road experts, ARB, to develop this winch-capable off-road bumper that offers the highest degree of vehicle integration, protection and functionality for 2019 Ranger.

Features Include:

- Welded all steel construction
- Rugged black textured powdercoat finish
- Accommodates OEM Ranger fog lights or RIGID's 2x2 off-road pod lamps in fog light openings



NOTE: Tow hooks required. For Ranger not originally equipped with tow hooks, see M-18954-RA or M-18954-RAB

NEW OFF-ROAD UNDER BODY/ROCK LIGHT KIT – WHITE
M-15200-RUN



Ford Performance worked with one of the most recognized names in Off-Road lighting – RIGID® – to offer Off-Road Light Kits which work with Ford vehicles. These lights are mounted in the wheel well or other strategic locations to enable off-road vehicles to illuminate trails as well as difficult, rocky terrain.



This kit contains:

- (4) RIGID® LED Rock Lights (White light)
- 15' leads to each light (4)
- Power distribution block, switch, and light mounts
- RIGID® Rock Lights contain a high quality black aluminum housing with a durable polycarbonate lens

NOTES:

- Warning–this part has been designed and is intended for off-highway application only
- Installation on a vehicle intended for use on public roads may violate U.S., Canadian, state or provincial laws and regulations including those relating to emission requirements and motor vehicle safety standards
- Installation of this part may adversely affect the warranty coverage on your vehicle

NEW 2019 RANGER 40" RIGID® LED LIGHT BAR KIT
M-15200K-R

Ford Performance worked with one of the most recognized names in Off-Road lighting – RIGID® – to develop this Off-Road Light Kit exclusively for 2019 Ranger equipped with a Ford Performance M-19007-R Chase Rack.

- This kit contains RIGID® Radiance Plus 40" light bar, unique harness, switch, and lens covers
- RIGID® Radiance Plus light bars include a high quality black aluminum housing, polycarbonate lens, black exposed circuit board, and forward facing optics that combine the attributes of a spot and flood beam pattern in a broad package
- Independently controlled (switchable) white back-lighting sets the appearance of this light bar apart from others
- The switch and unique harness aid in the installation of this package on a Ranger
- Included black lens covers both protect the lens of the light, while offering an alternative appearance.

NOTES:

- Warning – this part has been designed and is intended for off-highway application only.
- Installation on a vehicle intended for use on public roads may violate U.S., Canadian, state or provincial laws and regulations including those relating to emission requirements and motor vehicle safety standards.
- Installation of this part may adversely affect the warranty coverage on your vehicle.



NEW 2019 RANGER TOW HOOKS (PAIR)



- M-18954-RA Red
- M-18954-RAB Blue

Quickly and easily add a bold look and unique style to the front of any 2019 Ranger truck! These kits feature a pair of steel, powdercoated tow hooks in "Ford Performance" red or blue colors.

- Fits all 2019 Ranger SuperCrew and SuperCab models
- Works on 4x4 or 4x2 trucks
- Durable, unique red or blue powdercoated finish
- Sold in pairs

NOTE: Provisions for skid plates are not used on 4x2 models



NEW 2019 RANGER RAPTOR 17" X 8.5" – DYNO GRAY WHEEL

- M-1007-RGR1785OR Single Wheel
- M-1007K-RGR1785OR 4 Wheels w/TPMS Kit

- Fits 2019 Ranger 4WD Models
- Originally developed for the "Rest of World" Ford Ranger Raptor – wheels are now available in North America exclusively through Ford Performance Parts
- Premium OEM aluminum wheels with matte Dyno Gray finish and clear coated to OEM standards
- M-1007K-RGR1785OR includes four Ranger TPMS Sensors and Activaton Tool
- Includes "FORD" Raptor/Ranger style Center Cap(s)
- 17" x 8.5" wide



- 6-lug, 139.7 mm bolt circle
- 55 mm offset
- 177.5 mm backspacing

INSTALLATION NOTE: Use tape weights only for balancing. Flange weights are not recommended due to clearance requirements.

NEW RAPTOR/RANGER WHEEL CENTER CAP SET



M-1096K-RA

- Fits 2017-2019 Raptor
- Fits 2019 Ranger with Ford Performance wheel
- Sold as a set of four
- As included with 2019 Ranger Wheel M-1007-RGR1785OR
- As included with 2017-2018 Raptor Bead-Lock Wheel Kit M-1007-W1785B



NEW 2005-2019 FORD SUPER DUTY 20" X 8" WHEEL KIT WITH TPMS TOOL

M-1007K-SU2008EB

- Fits 2005 - 2019 F-Super Duty F-250 and F-350 Single Rear Wheel Models
- 20" x 8" Painted High Gloss Black Premium Aluminum Wheels
- OEM Quality - as originally offered on the 2019 F-250 & F-350 Super Duty Lariat Sport Package
- Includes two open and two closed "FORD" center caps painted high gloss black to match the wheels
- Includes four TPMS sensors and activation tool kit for use with 2017 - 2019 MY F-Super Duty applications
- 20" X 8.0"
- 8-lug 170 mm bolt circle



NEW 2018-2019 F-150 5.0L SUPERCHARGER KIT
M-6066-F150SCK



This new F-150 Supercharger has been developed by Ford Performance in partnership with Roush Performance, utilizing engineering expertise from both companies. Ford Performance and Roush are known for high-quality work, a vast support network, and having the utmost knowledge of Ford powertrains with a working relationship that goes back 50 years.

The R2650 Supercharger features new TVS Technology. The new Twin Vortices Series features new four-lobe rotors and high-flow inlet and outlet ports that greatly enhance thermal efficiency, enabling greater volumetric capacity at higher revolutions per minute (RPM). The Ford Performance Supercharger Kit is warranty friendly and rated at 650 horsepower. This new kit has been developed specifically for 5.0L V8 equipped F-150s.

- Fits 2018-2019 F-150 with 5.0L V8
- Produces 650 HP and 610 lb.-ft. of torque
- Kit comes complete with all hardware for installation
- Exclusive calibration 50 state emissions legal with CARB EO (D-418-33)

Kit Includes:

- 2.65L Twin Vortices (TVS) Supercharger Assembly
- Lower Intake Manifold with integral air-to-liquid intercooler
- 87 mm electric throttle body
- Complete Air Induction System (airbox, filter, and clean air tube)
- Fuel rails
- Complete air-to-liquid intercooler system includes pump, heat exchanger, and reservoir
- 47 lb/hr fuel injectors (M-9593-LU47)
- 3-year/36,000-mile Limited Powertrain Warranty included when installed by Ford dealer or an Automotive Service Excellence (ASE)-certified technician

NOTE: Powertrain calibrations are developed and supported for U.S. and Canadian vehicles only. Federal and state laws prohibit any person from installing aftermarket add-on or modified parts prior to the sale of a new motor vehicle.



FORD PERFORMANCE ENGINES

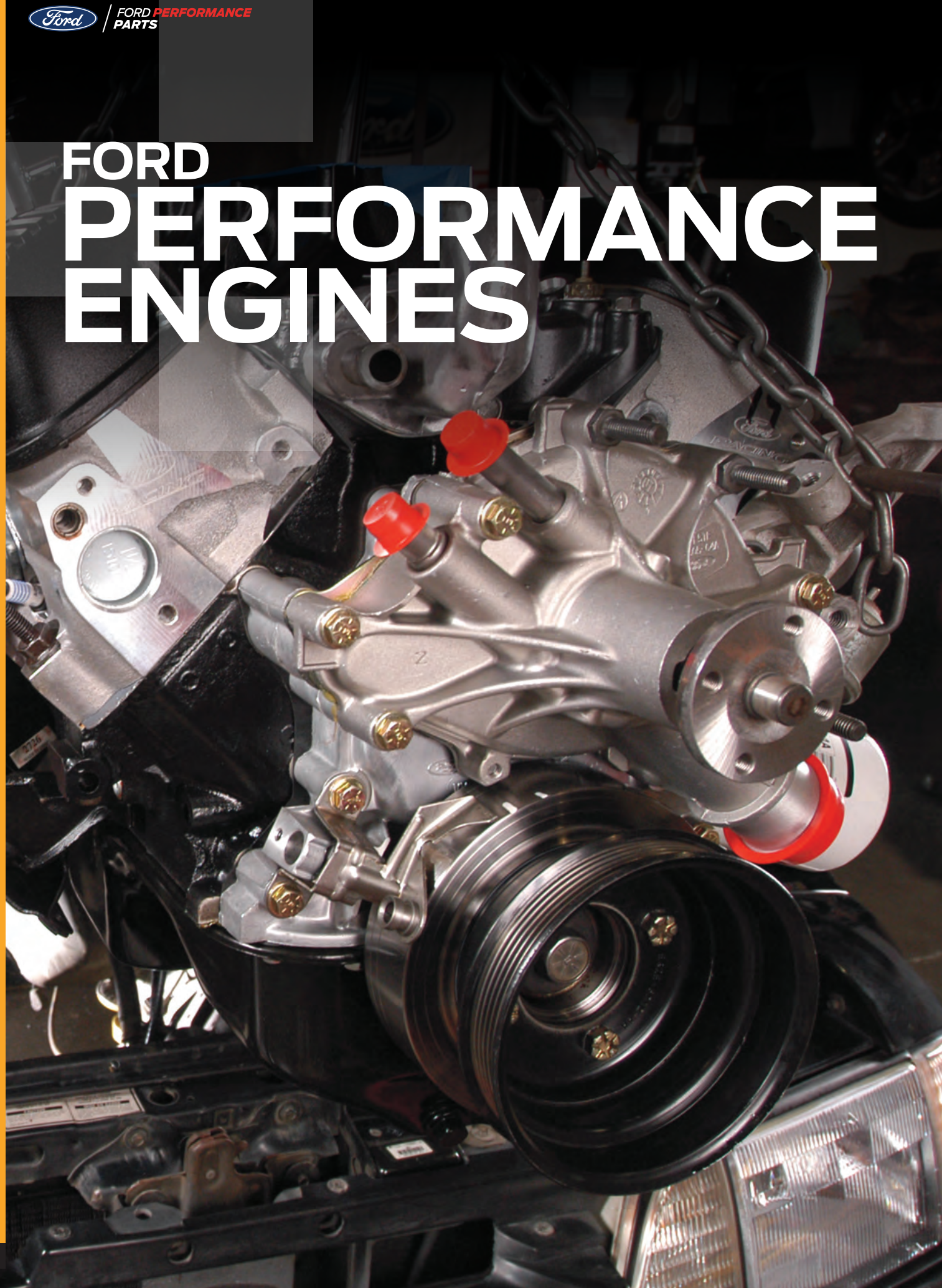

COYOTE MODULAR AND COMPONENTS

NEW GEN 3 5.0L POWER MODULE

M-9000-PMCM3* w/Tremec 6-speed manual transmission
 M-9000-PMCA3* w/10R80 10-speed automatic transmission

Complete Modern Powertrain Solution for Any Ford!

- NOW AVAILABLE WITH 2018-2019 Mustang GT 5.0L 460 HP Coyote Engine!
- Complete Engine Controller and Wiring Harness (Control Pack)

Next generation 5.0L power all in one complete powertrain kit. The crew at Ford Performance have spec'd out a kit to simplify the swap of our newest 5.0L Coyote engine into just about any Ford vehicle. The Coyote Power Module teams the Mustang GT 460 horsepower 5.0L Coyote V8 with a state of the art Tremec 6-speed manual or 10R80 10-speed automatic transmission - and all the electronics and hardware to finish the installation. The engine features advances like Direct and Port Fuel Injection, Twin Independent Variable Camshaft Timing, and a lightweight plasma transferred wire arc spray aluminum engine block. The Coyote Power Module simplifies both the shopping and build experience by kitting up the right parts that are matched to deliver potent performance with civilized drivability. The engine Control Pack is truly plug and play and simplifies conversions to a modern electronically fuel injected V8 high performance engine. Both modules include:

- 2018-2019 Mustang GT 5.0L Coyote Engine
- 460 Horsepower @ 7,000 rpm
- 420 lb.-ft. Torque @ 4,600 rpm
- 12.0:1 Compression ratio
- Aluminum block
- BOSS 302 Alternator Kit - M-8600-M50BALT
- Installation hardware
- Runs on premium pump gas
- Mustang GT 409 stainless-steel tubular exhaust manifold for the RIGHT SIDE ONLY

Manual Transmission Module

- Control Pack PCM and installation kit is tunable for power upgrades - M-6017-M50B
- M-11000-C50 starter and Starter Index Plate
- Steel Quicktime Bellhousing
- Roller Pilot Bearing - M-7600-B
- Tremec 6-Speed Transmission 2.66 1st gear - M-7003-M6266
- Clutch Fork / throw-out bearing
- Clutch Kit M-7560-T46
- Billet flywheel M-6375-G46A

NOTE: Engine will be fitted with dual mass flywheel installed. Included is billet flywheel, to be installed on engine before installation into vehicle

2011-2019 5.0L COYOTE STREET ROD CAST IRON EXHAUST MANIFOLDS

M-9430-SR50A

- Fits 2011-2019 5.0L Coyote engine
- From 2015-2017 Ford F-150 5.0L Coyote truck program
- Great for street rod builds or other Coyote swap projects where cast iron exhaust manifolds are desired

**Automatic Transmission Module**

- M-6017-M50BA Control Pack PCM and installation kit is tunable for power upgrades
- M-11000-C50A starter and Starter Index Plate
- 2018-2019 Mustang GT 10R80 10 speed automatic transmission, flexplate, and torque converter
- 2018-2019 Mustang GT 10R80 shifter

COYOTE MODULAR (CONTINUED)

NEW GEN 3 5.0L COYOTE 460 HP MUSTANG CRATE ENGINE

M-6007-M50C*

M-6007-M50CAUTO* Automatic Transmission Version



M-6007-M50C shown

The Ford Performance all-aluminum 2018 5.0L Coyote crate engine is a modern 5.0L 32-valve DOHC V8 that uses advanced features like direct and port fuel injection, Twin Independent Variable Camshaft Timing (Ti-VCT), high-flow cylinder heads, and heightened compression ratio to deliver 460 horsepower @ 7000 rpm and 420+ lb-ft of torque @ 4600 rpm (with premium fuel). The lightweight plasma transferred wire arc spray aluminum cylinder block features cross-bolted main bearing caps and thick main bearing bulkheads for bottom-end strength, optimized oil drainback and windage control helps improve high-rpm performance.

- 460 horsepower, 420+ lb-ft of torque
- 12.0:1 compression ratio
- Hypereutectic aluminum pistons
- Sintered steel connecting rods as used on BOSS 302 Mustang
- Forged steel crankshaft
- Aluminum block that features plasma transferred wire arc spray weld liner coating
- Longer, 12 mm head bolts for higher clamp load
- 10 qt capacity oil pan
- Tuned composite intake manifold provides efficient air delivery and weight savings
- 80 mm single bore "drive by wire," electronic throttle body with variable runner control
- High-flow aluminum cylinder heads, dual overhead camshaft (DOHC), four valves per cylinder, variable intake and exhaust camshaft timing
- Mustang GT 409 stainless-steel tubular exhaust manifold on the RIGHT SIDE ONLY
- Includes manual transmission engine harness and dual mass flywheel. For engine equipped with automatic transmission engine harness and flexplate, see M-6007-M50CAUTO (coming soon)
- Engine mount bosses and bellhousing mount pattern common to 4.6L modular engines
- Vehicle harness and PCM not included
- Use Ford Performance M-6017-M50B Control Pack, which includes wiring, PCM and installation kit, designed for project car installation
- Does not include alternator. For alternator kit see M-8600-M50BALT
- 5.0L Coyote air conditioning kit available, see M-8600-M50AC
- 5.0L Mustang motor mount kit available, see M-6038-M50
- 5.0L Mustang engine cover kit available, see M-9680-M50B
- Photo and specs may vary
- Engine weight: 445 lbs

WARNING: Cancer www.P65Warnings.ca.gov



GEN 3 5.0L COYOTE ALUMINATOR CRATE ENGINE

M-6007-A50SCB* 9.5:1 Compression Ratio
 M-6007-A50NAB* 12.0:1 Compression Ratio

The Ford Performance 5.0L Coyote Aluminator crate engine is a modern 5.0L 32-valve DOHC V8 that uses advanced features like direct and port fuel injection, Twin Independent Variable Camshaft Timing (Ti-VCT) and high-flow cylinder heads to deliver big power.



M-6007-A50NAB shown

Unlike the factory 5.0L engine, the Aluminator SC is built with low compression forged pistons and H-beam connecting rods to meet the demands of forced induction.

- Fits 2018-2019 Mustang GT
- 5.0L (302 cu in)
- 9.5:1 compression ratio for supercharged applications (nominal)
- 12:1 compression ratio for naturally aspirated applications
- Mahle® hard anodized forged pistons with Graphal® low friction coating
- Manley® H-beam connecting rods with ARP® 2000 bolts
- Mustang GT forged steel crankshaft
- Uses production Mustang GT aluminum cylinder block
- Longer, 12 mm head bolts for higher clamp load
- Large rear sump oil pan with 10 qt capacity features optimized oil drainback and windage tray to control oil and improve high-rpm performance
- Tuned composite Mustang GT intake manifold with production “drive by wire” throttle body
- Four-valve-per-cylinder aluminum heads with roller-finger followers reduce friction
- Mustang GT production camshafts
- Includes Ford Performance colder, heat range zero (0) spark plugs for supercharging – M-12405-M50
- Includes CM-6731-FL820 “Ford Racing” High-Performance Oil Filter
- Includes M-6600-M52 Billet Steel Gerotor Oil Pump
- Vehicle harness and PCM not included. Use Ford Performance wiring, PCM and installation kit M-6017-M50B designed for street rod/project car installation
- Engine mount bosses and bellhousing mount pattern common to 4.6L modular engines
- Engine does not include engine harness or flywheel/flexplate
- Does not include alternator. For alternator kit see M-8600-M50BALT
- Does not include exhaust manifolds

NOTE: Due to 9.5:1 compression ratio on M-6007-A50SCB, custom tuning is required for optimum performance.

COYOTE MODULAR (CONTINUED)



GEN 2 5.0L COYOTE ALUMINATOR SC CRATE ENGINE M-6007-A50SCA*

The Ford Performance 5.0L Coyote Aluminator crate engine is a modern 5.0L 32-valve DOHC V8 that uses advanced features like Twin Independent Variable Camshaft Timing (Ti-VCT) to deliver big power.

Unlike the factory 5.0L engine, the Aluminator is built with low compression forged pistons and H-beam connecting rods to meet the demands of forced induction.

- Fits 2015-2017 Mustang GT
- 5.0L (302 cubic inches)
- 9.5:1 compression ratio for supercharged applications (nominal)
- Mahle® hard anodized forged pistons with Graphal® low-friction coating
- Manley® H-beam connecting rods with ARP® 2000 bolts
- Mustang GT forged steel crankshaft
- Uses production Mustang GT aluminum cylinder block
- Large rear sump oil pan with 8 qt capacity features optimized oil drainback and windage tray to control oil and improve high-rpm performance
- Tuned composite Mustang GT intake manifold with production "drive by wire" 80 mm throttle body
- Four-valve-per-cylinder aluminum heads with roller-finger followers reduce friction
- Mustang GT production camshafts
- Intake: 13 mm lift/260° duration
- Exhaust: 13 mm lift/263° duration
- Heads feature M-6513-M50BR BOSS 302 Valve Springs
- Includes Ford Performance colder, heat range zero (0) spark plugs for supercharging, Part No. M-12405-M50
- Includes Ford Performance M-6731-FL820 Oil Filter
- Includes M-6600-50CJ Billet Steel Gerotor Oil Pump
- Vehicle harness and PCM not included. Use Ford Performance wiring, M-6017-504V PCM and Installation Kit designed for street rod/project car installation. Can also be equipped with automatic engine harness and then used in conjunction with automatic transmission controls pack – see M-6017-M50A for more information
- Engine does not include engine harness or flywheel/flexplate
- Does not include alternator; for alternator kit, see M-8600-M50BALT
- Engine mount bosses and bellhousing mount pattern common to 4.6L modular engines.

NOTE: Due to 9.5:1 compression ratio, custom tuning is required for optimum performance

- Includes Ford Performance M-9680-M50A 5.0L Mustang Engine Cover Kit (not pictured)
- Does not include exhaust manifolds

NOTE: In order for low oil sensor to function in 2015-2016 Mustang, reuse existing oil pan or replace with BR3Z-6675-A Pan, available at any Ford dealer.



GEN 2 5.0L COYOTE ALUMINATOR NA CRATE ENGINE

M-6007-A50NAA*

The Ford Performance 5.0L Coyote Aluminator crate engine is a modern 5.0L 32-valve DOHC V8 that uses advanced features like Twin Independent Variable Camshaft Timing (Ti-VCT) to deliver big power.



Unlike the factory 5.0L engine, the Aluminator is built with low compression forged pistons and H-beam connecting rods to meet the demands of forced induction.

This crate engine is used (and abused) in Justin Pawlak's Formula Drift Mustang!

- Fits 2015-2017 Mustang GT
- 5.0L (302 cubic inches)
- 11:1 compression ratio
- Mahle® hard anodized forged pistons with Graphal® low-friction coating
- Manley® H-beam connecting rods with ARP® 2000 bolts
- Mustang GT forged steel crankshaft
- Uses production Mustang GT aluminum cylinder block
- Large rear sump oil pan with 8 qt capacity features optimized oil drainback and windage tray to control oil and improve high-rpm performance
- Tuned composite Mustang GT intake manifold with production "drive by wire" 80 mm throttle body
- Four-valve-per-cylinder aluminum heads with roller-finger followers reduce friction
- Mustang GT production camshafts
- Intake: 13 mm lift/260° duration
- Exhaust: 13 mm lift/263° duration
- Heads feature M-6513-M50BR BOSS 302 Valve Springs
- Includes Ford Performance colder, heat range zero (0) spark plugs for supercharging, Part No. M-12405-M50
- Includes Ford Performance M-6731-FL820 Oil Filter
- Includes M-6600-50CJ Billet Steel Gerotor Oil Pump
- Vehicle harness and PCM not included. Use Ford Performance wiring, M-6017-504V PCM and Installation Kit designed for street rod/project car installation. Can also be equipped with automatic engine harness and then used in conjunction with automatic transmission controls pack – see M-6017-M50A for more information
- Engine does not include engine harness or flywheel/flexplate
- Does not include alternator; for alternator kit, see M-8600-M50BALT
- Engine mount bosses and bellhousing mount pattern common to 4.6L modular engines.

NOTE:

- Includes Ford Performance M-9680-M50A 5.0L Mustang Engine Cover Kit (not pictured)
- Does not include exhaust manifolds

NOTE: In order for low oil sensor to function in 2015-2016 Mustang, reuse existing oil pan or replace with BR3Z-6675-A Pan, available at any Ford dealer.



COYOTE MODULAR (CONTINUED)



5.2L ALUMINATOR 5.2 XS CRATE ENGINE

M-6007-A52XS*

Ford Performance has taken the technology and hardware developed for the Shelby GT350 Mustang and has created our ultimate naturally aspirated, 5.2L cross-plane crankshaft crate engine. With a rating of 580 hp, the new Aluminator 5.2 XS is the most powerful naturally aspirated modular crate engine ever built by Ford Performance. This is the worthy successor of our previous rendition – the “A50XS.”



Every Aluminator is hand-assembled by the same technicians who build the Mustang Cobra Jet drag racing engines. Premium aftermarket components are used to ensure durability, like unique Manley® connecting rods with ARP® rod bolts and Mahle® forged pistons. Unique components developed specifically for the Cobra Jet racing program are used, including Cobra Jet short runner – high-rpm intake manifold, 1517 CFM dual 65 mm CJ throttle body and competition high-rpm pulse ring.

Ford Performance engineers developed a balanced combination of high-end, 580 hp and strong mid-range torque with the Cobra Jet intake manifold, unique camshafts and fully CNC-ported GT350 cylinder heads.

Designed to work with 2015-2017 Mustang GT electronics – custom calibration required!

- 580 hp
- 445 lb-ft torque
- 5.2L (317 cubic inches)
- 12:1 compression ratio
- Mahle® hard-anodized forged pistons with Graphal® low-friction coating
- Unique Manley® H-beam connecting rods with ARP® 2000 bolts
- Unique Ford Performance M-6303-M52 Forged Steel Cross-Plane Crankshaft
- Uses Ford Performance M-6010-M52B Shelby GT350 Cylinder Block
- Ford Performance M-6675-M52 Shelby GT350 Oil Pan which features integrated windage and slosh baffles as well as an integrated oil pickup
- Ford Performance M-9424-M50CJ Cobra Jet Tuned Intake (will not clear production 2015-2017 hood without modification). Please contact Techline for more information
- Ford Performance M-9926-CJ65 Dual 65 mm Bore Throttle Body
- Four-valve-per-cylinder Shelby GT350 fully CNC-ported aluminum heads with roller-finger camshaft followers
- Unique Ford Performance M-6550-M52 Camshafts

Specifications:

- Intake camshaft – 14 mm lift/270° duration
- Exhaust camshaft – 14 mm lift/270° duration
- Low leak-rate Variable Cam Timing (VCT) phasers
- Robust primary timing chains as used on Shelby GT350R
- Ford Performance M-9593-LU47 47 lb Fuel Injectors
- Ford Performance M-12A227-CJ13 High RPM Pulse Ring
- Unique Ford Performance blue coil covers with added unique badging. This coil cover is not available anywhere other than the Aluminator 5.2 XS!
- Ford Performance M-12405-M50A Zero (0) Heat Range Spark Plugs
- Ford Performance M-6731-FL820 Oil Filter
- M-8600-M50BALTA 200 amp alternator and Front Engine Accessory Drive (FEAD) kit as used on the Cobra Jet race car
- Vehicle harness and PCM not included. Use Ford Performance M-6017-504V Control Pack which contains wiring, PCM and installation kit – designed for street rod/project car installation with a manual transmission. For automatic transmission version, please see M-6017-M50A Control Pack. Custom calibration required with either control pack!
- Engine does not include engine harness or flywheel/flexplate
- Engine mount bosses and bellhousing mount pattern common to 4.6L modular engines
- Headers not included
- Assembly plant lift brackets not included
- Premium unleaded fuel only!

NOTE: Custom PCM calibration required when installing crate engine in all vehicles, including 2015-2017 Mustang.

⚠ WARNING: Cancer www.P65Warnings.ca.gov

NEW CONTROL PACK - 2018 COYOTE 5.0L MANUAL TRANSMISSION
M-6017-M50B

Take the complexity and mystery out of wiring a late model, 2018 5.0L Mustang Coyote engine!

- Designed to run Ford Performance M-6007-M50C, M-6007-A50NAB and M-6007-A50SCB 5.0L Mustang Coyote engines
- Will also work with 2018-2019 5.0L Mustang Coyote engines with manual transmission
- NOTE:** Not for use with 2018 F-150 Engines
- Includes PCM with Ford Performance calibration
- Includes Electronic Throttle Control accelerator pedal which eliminates throttle cable routing problems
- Unique control pack harness replaces stock body harness and is designed for custom vehicle builds
- Features OBD-II diagnostic port to assist in vehicle calibration upload and problem diagnosis
- Includes power distribution module, air box, air inlet tube, MAF sensor, upper and lower radiator hoses and HEGO sensors
- PCM with Ford Performance calibration requires return type fuel system, will not work with returnless fuel system
- For 2011-2014 engines use controls pack M-6017-A504VA
- For 2015-2017 manual transmission version control pack use M-6017-504V
- For 2015-2017 automatic transmission version control pack (which works in conjunction with 6R80 transmission) use M-6017-M50A



NOTES: Supercharged versions, modified engines, and modified applications require custom calibration. Installation of this PCM in a 2018 Mustang GT will result in a no-start condition.

NEW CONTROL PACK - 2011-2014 COYOTE 5.0L 4V MANUAL TRANS WITH SPEED DIAL
M-6017-A504VB

Take the complexity and mystery out of wiring a late model 5.0L 4V Ti-VCT engine!

Replaces M-6017-A504VA Control Pack – includes wiring for M-4209ADPT-AC Speed-dial Speedometer Adjuster to pick up transmission output speed.

- Designed to run 2011-2014 5.0L 4V Coyote engines M-6007-M50 and M-6007-A50NA 5.0L with manual transmission
- M-6007-A50SC, M-6007-A50XS, M-6007-M50B (BOSS 302) and F-150 truck engines require modifications. Call the Ford Performance Techline at (800)367-3788 for more information
- Includes PCM with Ford Performance calibration. Supercharged, M-6007-A50SC, M-6007-A50XS, M-6007-M50B (BOSS 302) and F-150 truck engines require custom calibration
- Includes electronic throttle control accelerator pedal, eliminating throttle cable routing problems
- Unique control pack harness replaces stock body harness and is designed for custom vehicle builds
- Features OBD-II diagnostic port to assist in vehicle calibration upload and problem diagnosis
- Includes power distribution module, air-box, air inlet tube, MAF sensor, upper and lower radiator hoses, PCV hoses and HEGO sensors
- PCM with Ford Performance calibration requires return-type fuel system. Will not work with returnless fuel system



NOTE: Installation of this PCM in a 2011-2014 Mustang GT will result in a no-start condition.

*This component is eligible for the Ford Performance Parts Limited Warranty. See the Ford Performance Parts Limited Warranty on pages 217-225 for details.

COYOTE MODULAR (CONTINUED)

NEW GEN 3 5.0L COYOTE LONG BLOCK

M-6006-M50C*

This long block assembly is from the Ford Performance all-aluminum 2018-2019 5.0L Coyote crate engine.



M-6006-M50BOSS shown

This engine is a modern 5.0L 32-valve DOHC V8 that uses advanced features like Direct and Port Fuel Injection, Twin Independent Variable Camshaft Timing (Ti-VCT), high-flow cylinder heads, and heightened compression ratio. The lightweight plasma transferred wire arc spray aluminum cylinder block features cross-bolted main bearing caps and thick main bearing bulkheads for bottom-end strength, optimized oil drainback and windage control to improve high-rpm performance.

- 12.0:1 Compression ratio
- Hypereutectic aluminum pistons
- Sintered steel connecting rods as used on BOSS 302 Mustang
- Forged steel crankshaft
- Aluminum block which features plasma transferred wire arc spray weld liner coating
- Longer, 12 mm head bolts for higher clamp load
- 10 qt capacity oil pan
- High-flow aluminum cylinder heads, dual overhead camshaft (DOHC), four valves per cylinder, variable intake and exhaust camshaft timing
- Engine mount bosses and bell housing mount pattern common to 4.6L modular engines

This long block assembly does not include:

- Intake manifold/throttle body
- Fuel rails/fuel injectors
- Water pump pulley
- Alternator
- Exhaust manifolds
- Flywheel/flexplate
- Engine wiring/PCM
- Photo and specs may vary
- Engine weight: 445 lbs.



GEN 1 5.0L COYOTE LONG BLOCK M-6006-M50A1*

The M-6006-M50A1 Long Block has been developed for the customer that needs a Coyote that will run in a "Gen 1", 2011-2014 Mustang or run with a "Gen 1" engine control system.



This long block offers a performance improvement in 2011-2014 Mustangs due to the performance enhancing updates/components noted below:

- Larger intake valves than GEN 1
- Larger exhaust valves than GEN 1
- Revised intake camshafts from GEN 1
- Revised exhaust camshafts from GEN 1
- Stiffer valve springs to ensure that the valves close completely at high rpm
- New cylinder-head casting, including revised ports that provide a straighter path to the valves for less-restrictive intake and exhaust flow and combustion chamber modifications to accommodate larger valves
- Redesigned piston tops with deeper cutouts to clear the new larger valves
- Rebalanced forged crankshaft that supports higher-rpm operation
- 11.0:1 Compression ratio
- Hypereutectic aluminum pistons
- Forged connecting rods
- Forged steel crankshaft
- Aluminum block
- 8 qt. capacity oil pan
- Aluminum cylinder heads, DOHC, four valves per cylinder, Variable intake and exhaust camshaft timing
- Engine mount bosses and bell housing mount pattern common to 4.6L modular engines
- Engine weight: 444 lbs
- Photo and specs may vary

Many of the above improvements to the GEN 2, 2015-2017 Coyote focus on allowing it to breathe better. The improvements, many of which are derived from the lessons learned in developing the special edition 2012-2013 Mustang BOSS 302, allow for better breathing, especially at higher engine speeds.

⚠ WARNING: Cancer www.P65Warnings.ca.gov

This long block does not include the following:

- Intake manifold and throttle body
- Fuel rails and fuel injectors
- Water pump pulley
- Ignition coils, see Ford Performance Ignition Coils
- Exhaust manifolds
- Flywheel/Flex plate, see M-12000-M50 or M-12000-M50A
- Engine wiring harness or PCM, use M-6017-A504VA for street rod application
- Alternator-Ford Performance alternator kit available, see M-8600-M50BALT

NOTE: Long block is compatible with engine harness (VCT harnesses) built after 2/27/2012, see M-12508-M50 if your engine is currently equipped with early VCT solenoids and engine harness

NOTE: Custom calibration required, not included

NOTE: For more information on 5.0L Coyote engines, please see-Inside the Development of the Ford Performance 5.0L Coyote Long Block, GEN 1 Crate Engine and Coyote Crate Engine Technical Reference Guide at our website: www.performanceparts.ford.com

COYOTE MODULAR (CONTINUED)
5.0L GEN 3 COYOTE ALUMINATOR SHORT BLOCK
M-6009-A50NAB NA Short Block 12.0:1 Ratio

M-6009-A50SCB SC Short Block 9.5:1 Ratio

Just like the fully built up engines, Aluminator Short Blocks are hand assembled and use Manley® connecting rods with ARP® rod bolts and Mahle® forged pistons. Two versions are available – 9.5:1 and 12.0:1 compression ratio.

M-6009-A50NAB

M-6009-A50SCB

These Aluminator Short Blocks serve as a strong foundation for the enthusiast that wants to spec and finish a 3rd Gen Coyote build to his or her particular application and needs.

Ford Performance Engineers have taken care of the toughest part of building a new engine by designing a strong and durable Short Block that offers a wide range of power possibilities. Every Ford Performance Aluminator Short Block is precision internal balanced and hand assembled in the U.S. with performance clearances.

Ford Performance offers a number of components to finish the build including the simple to install Controls Pack to get it up and running in just about any vehicle – from Early Model Mustangs to resto-rods to classic muscle cars to street rods.

Specs: M-6009-A50NAB Aluminator Short Block

- 5.0L - 302 cubic inches
- 12.0:1 compression ratio (nominal)
- For 9.5:1 compression ratio version see-M-6009-A50SCB
- Mahle® hard anodized forged pistons with Grafal® low friction coating
- Manley® H-beam connecting rods with ARP2000 bolts
- 2018-2019 (Gen 3) Ford Performance lightweight plasma transferred wire arc spray aluminum cylinder block features cross-bolted main bearing caps and thick main bearing bulkheads for bottom-end strength, optimized oil drainback and windage control to improve high-rpm performance.
- High Performance billet steel oil pump gears
- 2018-2019 Coyote Head Changing kit recommended M-6067-M5018 (Gen 3 head gaskets required)
- Assembled and ready for your 5.0L heads, cams, and timing set
- Modified heads and aftermarket cams require checking piston to valve clearance

NOTE: Fits 2015-2017 5.0L cylinder heads, 2018-2019 5.0L cylinder heads, 2015+ 5.2L cylinder heads

NOTE: Installation of 5.2L heads require checking piston to valve clearance

Photo and specs may vary

Specs: M-6009-A50SCB Aluminator Short Block

- 5.0L - 302 cubic inches
- 9.5:1 compression ratio (nominal)
- For 12.0:1 compression ratio version see-M-6009-A50NAB
- Mahle® hard anodized forged pistons with Grafal® low friction coating
- Manley® H-beam connecting rods with ARP2000 bolts
- 2018-2019 (Gen 3) Ford Performance lightweight plasma transferred wire arc spray aluminum cylinder block features cross-bolted main bearing caps and thick main bearing bulkheads for bottom-end strength, optimized oil drainback and windage control to improve high-rpm performance.
- High Performance billet steel oil pump gears
- 2018-2019 Coyote Head Changing kit recommended M-6067-M5018 (Gen 3 head gaskets required)
- Assembled and ready for your 5.0L or 5.2L heads, cams, and timing set
- Modified heads and aftermarket cams require checking piston to valve clearance

NOTE: Fits 2015-2017 5.0L cylinder heads, 2018-2019 5.0L cylinder heads, 2015+ 5.2L cylinder heads

NOTE: Installation of 5.2L cylinder heads require checking piston to valve clearance

Photo and specs may vary

NEW 5.0L GEN 2 COYOTE ALUMINATOR SHORT BLOCK

M-6009-A50NAA NA Short Block 11.0:1 Ratio
 M-6009-A50SCA SC Short Block 9.5:1 Ratio

Just like the fully built-up engines, Aluminator short blocks are hand assembled and use Manley® connecting rods with ARP® rod bolts and Mahle® forged pistons. Two versions are available – 9.5:1 and 11.0:1 compression ratio.

These Aluminator short blocks serve as a strong foundation for the enthusiast who wants to spec and finish a Coyote build to his or her particular application and needs.

Ford Performance engineers have taken care of the toughest part of building a new engine by designing a strong and durable short block that offers a wide range of power possibilities. Every Ford Performance Aluminator short block is precision internal balanced and hand-assembled in the U.S. with performance clearances.

Ford Performance offers a number of components to finish the build, including the simple-to-install control pack to get it up and running in just about any vehicle – from early model Mustang to resto-rods to classic muscle cars to street rods.

Specs: M-6009-A50SCA Aluminator Short Block

- 5.0L 302 cubic inches
- 9.5:1 compression ratio (nominal)
- For 11.0:1 compression ratio version, see M-6009-A50NAA
- Mahle® hard anodized forged pistons with Graphal® low-friction coating
- Manley® H-beam connecting rods with ARP® 2000 bolts
- 2015-2017 (GEN 2) production aluminum cylinder block features cross-bolted main bearing caps and thick main bearing bulkheads for bottom-end strength
- Ford Performance M-6600-50CJ High-Performance Billet Steel Gerotor Oil Pump and Pickup Tube
- Photo and specs may vary

Specs: M-6009-A50NAA Aluminator Short Block

- 5.0L 302 cubic inches
- 11.0:1 compression ratio (nominal)
- For 9.5:1 compression ratio version, see M-6009-A50SCA
- Mahle® hard anodized forged pistons with Graphal® low-friction coating
- Manley® H-beam connecting rods with ARP® 2000 bolts
- 2015-2017 (GEN 2) production aluminum cylinder block features cross-bolted main bearing caps and thick main bearing bulkheads for bottom-end strength
- Ford Performance M-6600-50CJ High-Performance Billet Steel Gerotor Oil Pump and Pickup Tube
- This short block includes the GEN 2 oil filter adapter
- Assembled and ready for your 5.0L heads, cams and timing set
- Modified heads and cams larger than the M-6550-M50BINT/M-6550-M50BEXH require checking piston-to-valve clearance

NOTE: Installation of 5.2L heads require piston modification for proper piston-to-valve clearance

Photo and specs may vary



⚠ WARNING: Cancer www.P65Warnings.ca.gov

M-6009-A50SCA



⚠ WARNING: Cancer www.P65Warnings.ca.gov

M-6009-A50NAA

COYOTE MODULAR (CONTINUED)
NEW 5.2L COYOTE ALUMINUM ENGINE BLOCK

M-6010-M52B GEN 3
M-6010-M52A GEN 2

Upgraded version of previous Ford Performance M-6010-M52 and M-6010-M52A 5.2L Coyote Aluminum Cylinder Blocks.

Specs: M-6010-M52B GEN 3 ENGINE BLOCK

- Features higher flow oil squirters to provide added piston cooling
- Rod bolt path is clearance machined in crancase of block
- Improved high-performance casting of the Coyote block with improvements to support higher horsepower engine builds
- Utilizes Longer (187mm) 12 mm cylinder head bolts to provide greater clamping force (requires longer Head Bolt Kit - M-6067-M501280, or M-6067-M52B head changing kit)
- Improved crankcase windage
- 94.0 mm bore
- Water jacket below cylinder bore has been updated to add more material for strength
- The intake side of the bore at the deck surface includes a cast-in brace to improve strength of the cylinder wall and head gasket sealing
- Block features plasma transferred wire arc spray weld liner coating
- Liner coating provides improved durability and heat transfer, reduced friction, and a weight savings compared to previous 5.0L Mustang GT aluminum blocks
- Cylinder liner coating does not require unique piston rings or piston material
- Cylinder bores are finish-honed and ready to assemble
- All block features are finish-machined including head deck and crank bore
- Cross-bolted nodular iron main bearing caps
- Block has provisions for piston oil squirters
- Includes plugs and dowels, and oil squirters
- Uses 12 mm cylinder head bolts

Specs: M-6010-M52A GEN 2 ENGINE BLOCK (Shown above)

Improved high-performance casting of the Coyote block with improvements to support higher horsepower engine builds.

- Utilizes longer (187 mm) 12 mm cylinder head bolts to provide greater clamping force (requires longer Head Bolt Kit - M-6067-M501280, or M-6067-M52B head changing kit)
- Improved crankcase windage
- 94.0 mm bore
- Water jacket below cylinder bore has been updated to add more material for strength
- The intake side of the bore at the deck surface includes a cast-in brace to improve strength of the cylinder wall and head gasket sealing
- Block features plasma transferred wire arc spray weld liner coating
- Liner coating provides improved durability and heat transfer, reduced friction, and a weight savings compared to previous 5.0L Mustang GT aluminum blocks
- Cylinder liner coating does not require unique piston rings or piston material
- Cylinder bores are finish-honed and ready to assemble
- All block features are finish-machined including head deck and crank bore
- Cross-bolted nodular iron main bearing caps
- Uses 12 mm cylinder head bolts
- Block has provisions for piston oil squirters
- Includes plugs and dowels, and oil squirters

NEW 5.0L COYOTE PRODUCTION ENGINE BLOCK

M-6010-M504VC GEN 3
M-6010-M504V GEN 1

Specs: M-6010-M504VC GEN 3 ENGINE BLOCK

Original equipment for the 2018 Mustang GT 5.0L.

- 93.0 mm bore
- Block features plasma transferred wire arc spray weld liner coating Liner coating provides improved durability and heat transfer, reduced friction, and a weight savings compared to previous Mustang GT aluminum block
- Cylinder bores are finish-honed and ready to assemble
- All block features are finish-machined including head deck and crank bore
- Cross-bolted nodular iron main bearing caps Uses 12mm cylinder head bolts
- Block has provisions for piston oil squirters (included)
- Includes plugs and dowels

Specs: M-6010-M504V GEN 1 ENGINE BLOCK

Mustang GT 5.0L 4V Coyote production aluminum block.

- Fits 2011-2014 Mustang; will not fit 2015
- Low-pressure cast 319 aluminum
- Pressed-in thin-wall iron liners
- 92.2 mm bore size
- Cross-bolted nodular iron main bearing caps
- Block features 11 mm cylinder head bolts (2011-2012 engine builds using this block will require 11 mm head bolts)
- Block has provisions for engine oil squirters
- Includes dowels and plugs



M-6010-M504VC



M-6010-M504V

5.0L COYOTE ALUMINUM PERFORMANCE BLOCK M-6010-M50R

Special casting of the 5.0L Coyote block with improvements to support higher horsepower engine builds.

- Water jacket below cylinder bore has been updated to add more material for strength
- The intake side of the bore at the deck surface includes a cast-in brace to improve strength of the cylinder wall and head gasket sealing
- 1/4" drain plug provision on right side of block for coolant draining
- Low-pressure cast 319 aluminum
- Pressed-in thin-wall iron liners
- 92.2 mm bore size
- Cross-bolted nodular iron main bearing caps
- Uses 11 mm cylinder head bolts
- This block is compatible with GEN 1 (2011-2014) and GEN 2 (2015-2017) cylinder heads
- Note that the head gasket must match the cylinder head
- Must use GEN 1 oil filter adapter
- Block has provisions for piston oil squirters
- Includes plugs and dowels

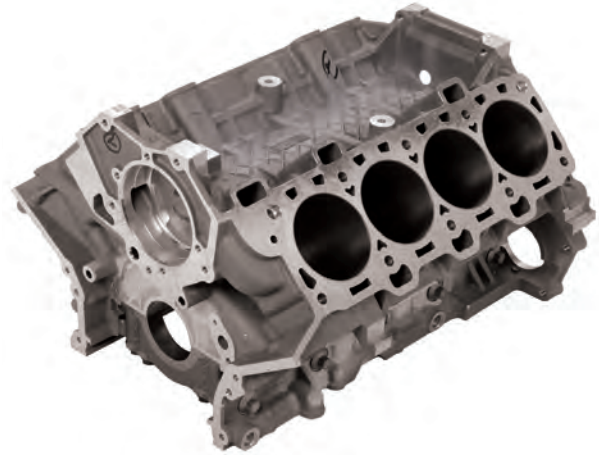

NEW MUSTANG SHELBY GT500 5.4L PRODUCTION ALUMINUM CYLINDER BLOCK M-6010-M54A

Original equipment for the 2011-2012 Mustang Shelby GT500.

- Approximately a 100 lb weight savings over the cast iron 5.4L block
- Design based on M-6010-GT block with improved oil drainbacks
- Six-bolt main bearing caps for high-performance durability
- Block features Plasma Transferred Wire Arc (PTWA) liner coating, a process that applies a 150-micron composite coating that contains nanoparticles on the internal surfaces of engine cylinder bores, replacing cast-iron liners typically used in aluminum engine blocks
- Liner coating provides improved durability and heat transfer, reduced friction, and a weight savings compared to the Ford GT aluminum block
- Cylinder bores are finish honed 90.2mm bore, ready to assemble
- All block features are finish machined including head deck and crank bore
- Cylinder liner coating does not require unique piston rings or piston material



MODULAR AND COYOTE ENGINE SHIPPING AND STORAGE CRADLE M-6038-M

- Fits all modular 4.6L-5.8L and all Coyote 5.0L and 5.2L engines
- Does not fit M-6010-BOSS50 Block
- Fabricated metal shipping and storage rack
- Cradle base has four 1/2" holes to bolt the cradle to a pallet or for coasters
- Black powdercoat
- Includes bolts
- This is the same shipping cradle used by Ford Performance on select Aluminator engines
- Made in the USA



COYOTE MODULAR (CONTINUED)

5.0L COYOTE BLOCK HARDWARE KIT 2011-2019 M-6026-A50A

Hardware kit for use in 2011-2019 5.0L Coyote engine builds.

Kit includes:

- Main cap bolts
- Piston cooling nozzles
- .75" cup plug
- 13.84 mm cup plug
- 14 mm cup plug
- Transmission dowels
- Front/rear cover dowels
- Cylinder head dowels
- Timing chain guide dowels



5.0L COYOTE MOTOR MOUNT KIT M-6038-M50

- Fits 2011-2019 5.0L Mustang GT and 2015-2019 5.2L GT350, A52XS engines
- Coyote engine mount kit for engine swaps
- Includes cast aluminum engine brackets, engine mounts and hardware



5.0L COYOTE MUSTANG FORGED CRANK M-6303-M50B

- Finish machined-forged steel crankshaft as used in the production 5.0L Coyote Mustang engines
- 92.7 mm stroke
- Balance is compatible with the 2015-2017 Coyote Mustang connecting rod and piston assembly
- Requires balancing if used with non-production rod and piston assembly



COYOTE CRANKSHAFT RAW FORGING M-6303-M50RF

- Raw crankshaft forging for the 5.0L Coyote engine
- This crankshaft has no machining
- Will accommodate strokes of 92.7 mm to 95.7 mm with a standard journal size, or larger with a smaller rod journal size



COYOTE 5.2L FORGED CRANKSHAFT M-6303-M52

- Finish machined cross plane forged steel crankshaft for use with the M-6010-M52, M-6010-M52A, M-6010-M52B Coyote Blocks
- 93 mm stroke
- Standard main and rod journal sizes
- Will require balancing



NEW 5.0L/5.2L HIGH STRENGTH FORGED STEEL CRANKSHAFT SPROCKET M-6306-M50A

This crankshaft sprocket is designed for race applications. This forged steel crankshaft sprocket is approximately 5x stronger than the factory powdered metal sprocket found on 2015-2017 5.0L engines and offers enthusiasts peace of mind. The factory powdered metal sprocket works effectively in stock applications but when additional horsepower, RPM, and/or the stress caused by belt mounted power adders or accessories are added-this sprocket can help to avoid a costly rebuild.

Fits:

- 2015-2017 Mustang GT 5.0L
- 2015-2018 Mustang GT350 5.2L
- 2015-2018 F-150 5.0L
- Produced by OEM manufacturer to minimum allowable tolerances
- Complements billet oil pump gears found here [M-6600-M50A](#)



5.2L / 5.0L MAIN BOLT KIT M-6345-M52

- Fits 2011-2018 5.2L GT350 and 5.0L Coyote blocks
- Complete set of production main cap and side bolts
- These are one-time use torque-to-yield bolts



5.0L TI-VCT BILLET STEEL GEROTOR OIL PUMP M-6600-50CJ

- Fits all 2011-2017 5.0L Ti-VCT engine applications
- Oil pump assembly with billet steel gerotor set
- Produced by OEM manufacturer to minimum allowable tolerances
- Pump assembly is pressure and flow tested with OEM procedure
- Recommended for race and power adder applications
- Used on 2013-2014 Cobra Jet engines and Ford Performance Aluminator crate engines



2011-2014 5.0L 4V TI-VCT OIL LINE ADAPTOR M-6881-M50

- Fits 2011-2014 5.0L Coyote engines
- Blue anodized billet aluminum oil line adaptor replaces oil filter adapter
- Allows installation of remote mounted oil filter and oil cooler
- Designed for -10 AN lines with O-ring port fittings
- Includes adapter-to-engine block O-rings and mounting bolts
- Can be used with M-6007-M50, M-6007-A50NA, M-6007-A50SC, M-6007-A50XS crate engines when stock oil filter requires relocation
- Recommended for street car applications



WARNING: Your selection of fittings and filter adapter may restrict oil flow, causing engine damage.

5.0L COYOTE OIL PUMP INSTALLATION KIT M-6600-A50PKIT

- Fits 2011-2017 5.0L Coyote Mustang GT and F-150 engines
- This kit is intended to be used when installing an oil pump on a 5.0L Coyote engine

Kit includes:

- Timing cover gaskets and seals
- Oil pan gaskets
- Damper bolt
- Damper seal
- 2011-2014 valve cover gaskets (8.5mm tall)

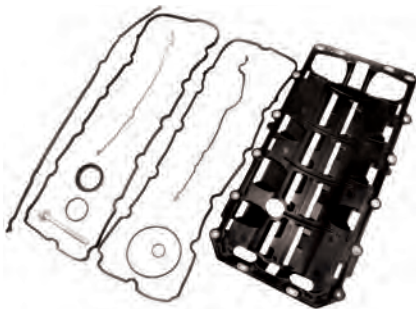

5.0L/5.2L COYOTE LOW VOLUME OIL PUMP M-6600-50

This low volume oil pump is designed for race applications. This pump reduces engine oil pressure, to decrease engine load. When used in competitive applications, a difference in oil pressure can promote engine efficiency, and can increase the overall performance of a vehicle.



- Fits 2011-2019 5.0L Mustang engines
- Fits 2011-2019 5.0L F-150 engines
- Fits 2015-2019 Mustang GT350 5.2L

- Includes:**
- Oil pump
 - Attachment hardware

NOTE: For use with 5.2L engines, use 5.0L pickup tube. Pump does not contain billet oil pump gears

MUSTANG BOSS 302 ENGINE OIL COOLER M-6642-MB

- Original equipment on 2012-2013 Mustang BOSS 302. Fits 2011-2014 Mustang GT with 5.0L 4V Ti-VCT engine
- Engine-mounted oil cooler
- Water-to-oil type cooler
- Kit includes BOSS 302 radiator hose with integral oil cooler fitting
- Uses M-6731-FL820 Ford Performance High-Performance Oil Filter



2017 GEN 2 5.0L COYOTE OIL PAN KIT M-6675-M50A1

The perfect complement to a Ford Performance Aluminator engine install, this oil pan kit enables enthusiasts to install a Gen 2 Aluminator engine into a 2015-2016 Mustang 5.0L and not have to worry about a "Low Oil Level" malfunction indicator light illuminating.

- Fits 2011-2017 5.0L engines

Kit includes:

- 5.0L oil pan
- Attachment hardware
- Gasket with integrated windage tray
- Jumper harness which disables low oil level sensor

NOTE: This pan defeats the low oil level sensor in 2015-2016 Mustang 5.0L. To maintain functionality, reuse existing oil pan, or purchase BR3Z-6675-A from a Ford dealer.



NEW GEN 3 ENGINE MANUAL TRANSMISSION UPFIT KIT M-12000-M50B

- Fits 2018-2019 GEN 3 Coyote engines
- Kit includes the parts to upfit a Coyote Engine for use with a manual transmission

Kit includes the OEM production parts:

- Pilot Bearing Assembly (1C3Z-7600-AB)
- Flywheel (BR3Z-6375-D)
- Manual Coyote 5.0 Flywheel Bolts (BR3Z-6379-A)
- Engine Harness (HU5Z-12A581-E)



COYOTE MODULAR (CONTINUED)
**COYOTE ENGINE MANUAL TRANSMISSION UPFIT KIT
M-12000-M50**

Fits 2015-2017 GEN 2 Coyote engines. Kit includes the parts to upfit a Coyote engine for use with a manual transmission.

Kit includes the OEM production parts:

- Pilot bearing assembly (1C3Z-7600-AB)
- Flywheel (BR3Z-6375-D)
- Manual Coyote 5.0 flywheel bolts (BR3Z-6379-A)
- Engine harness (HU5Z-12A581-E)

**COYOTE ENGINE AUTOMATIC TRANSMISSION UPFIT KIT
M-12000-M50A**

Fits 2015-2017 GEN 2 Coyote engines. Kit includes the parts to upfit a Coyote engine for use with a 6R80 automatic transmission.

Kit includes the OEM production parts:

- Flexplate bolts (AL3Z-6379-BA)
- Flexplate (BL3Z-6375-A)
- Engine harness (HU5Z-12A581-D)

**5.0L/5.2L BILLET STEEL GEROTOR OIL PUMP GEAR SET
M-6600-M50A**

This gear set is designed for race applications. These billet oil pump gear sets can be installed into a factory housing and offer enthusiasts peace of mind. The stock powdered metal oil pump gears work effectively in stock applications, but when additional horsepower, rpm, and/or the stress caused by belt mounted power adders or other aftermarket setups are added, these billet gears can help avoid a costly rebuild.

- Fits 2011-2019 Mustang GT 5.0L oil pump
- Fits 2015-2019 Mustang GT350 5.2L oil pump
- Produced by OEM manufacturer to minimum allowable tolerances
- Requires installation in factory oil pump
- For complete gerotor oil pumps with billet gear sets installed, see M-6600-50CJ or M-6600-M52
- Works well with M-6600-A50PKIT 5.0L Coyote Oil Pump Installation Kit



NOTE: Does not fit stock 2011-2018 F-150 5.0L oil pump. For 2011-2017 F-150 5.0L applications, use the M-6600-50CJ oil pump, for 2018 F-150 5.0L, use the M-6600-M52 oil pump.

**COYOTE/GT350 PRIMARY TIMING CHAIN SET
M-6004-GT350PC**

Upgrade the primary timing chains of your 5.0L Coyote engine by swapping them out for the GT350 5.2L primary timing chains! These chains offer 10% greater strength over 5.0L Coyote timing chains. Oriented for racing applications.

- Fits 2015-2017 Mustang GT 5.0L
- Original equipment on 2015-2019 Mustang GT350R and GT350R 5.2L
- Set includes two GT350 primary timing chains

**2015-2017 5.0L / 5.2L COYOTE HIGH-PERFORMANCE
CAM PHASER
M-6004-A50R**

Variable cam timing (VCT) phasers require proper oil pressure to function correctly. It is inherent that all cam phasers have a certain oil leak rate. These high-performance cam phasers have a much lower leak rate than stock, allowing better control of the phasers at higher engine speeds and loads. These cam phasers are oriented for racing applications.



- Fits 2015-2017 Mustang GT 5.0L
- Original equipment on 2015-2019 Mustang GT350R 5.2L
- Includes 2 intake cam and 2 exhaust cam phasers

**2010-2019 3.5L ECOBOOST® COLD SPARK PLUG SET
M-12405-35T**

- Fits 2011-2019 F-150 3.5L EcoBoost®
- Fits 2010-2019 Taurus SHO 3.5L EcoBoost®
- Fits 2010-2019 Flex 3.5L EcoBoost®
- For use in engines with higher-than-stock cylinder combustion pressures
- One heat range colder than stock spark plug
- Sold in sets of 6
- Spark plugs gapped to 0.031" (0.8 mm)

**NEW COYOTE 5.0L/5.2L ROAD RACE OIL PAN
M-6675-M52RR**

- Fits 2011-2017 5.0L engines and 2015-2019 5.2L engines
- As used on Shelby FP350S race car
- Internal baffle and trap door system designed for road race applications
- Baffle design optimized based on Shelby FP350S development at famous road course tracks including VIR (Virginia International Raceway)
- 12 quart capacity
- Black powdercoated steel pan
- Pipe plug fitting for oil temperature gauge

NOTE:

- Does not include pickup tube
- For 5.0L applications use M-6622-M50RR pickup tube
- For 5.2L applications use M-6622-M52RR pickup tube



2011-2017 5.0L COYOTE 4V TI-VCT RACE OIL PAN M-6675-M50BR

- Fits 2011-2017 Mustang 5.0L Coyote Ti-VCT engine
- Used on Mustang BOSS 302R, BOSS 302S and 2013 Cobra Jet Mustang engine
- Internal baffle system designed for road race applications
- 12 qt capacity
- Includes oil pickup tube
- Black powdercoated
- Pipe plug fitting for oil temperature gauge



5.2L COYOTE GT350 OIL PAN AND PUMP KIT M-6675-M52

- Fits all 5.2L, and Gen 1 and Gen 2 5.0L Coyote engines
- Includes the production GT350 high-output oil pump, oil pan, high-pressure oil pressure sending unit and hardware
- This unique composite oil pan includes integrated windage and slosh baffles and the oil pickup integrated into the floor of the pan
- Used on Ford Performance M-6007-A52XS Engine



302 ENGINE-UNIVERSAL OIL DIPSTICK/TUBE M-6622-302

- As used on Ford Performance engines, this dipstick is a universal fit for engines which use a Canton, or Canton-style race oil pan
- Attaches via 1/4" NPT (female) bung on oil pan, (male 1/4" NPT fitting on tube)
- Includes dipstick tube and dipstick
- Can be bent to fit depending on application
- Note-shortening the length of tube is necessitated in some applications for correct oil capacity reading



NEW 5.0L COYOTE STYLE ROAD RACE OIL PUMP PICK UP TUBE M-6622-M50RR

This unique oil pump pickup tube utilizes a bolt-on style attachment which works with 2011-2017 (Gen 1 & Gen 2) 5.0L engines, when using Ford Performance oil pan.

- Fits: 2011-2017 5.0L engines with M-6675-M52RR Ford Performance Road Race Oil Pan



NEW OIL SUMP PICKUP TUBE M-6622-M52RR

As used on Shelby FP350S road race car, this unique oil pump pickup tube utilizes a grommet-style attachment which works with 5.2L and 2018+ (Gen 3) 5.0L engines when using Ford Performance oil pan.

Fits:

- 2015-2018 5.2L engines with M-6675-M52RR Ford Performance Road Race Oil Pan
- 2018-2019 5.0L engines with M-6675-M52RR Ford Performance Road Race Oil Pan



COYOTE GEN 2 OIL FILTER ADAPTER KIT M-6880-M501

- Oil filter adapter for use on the 2015-2017 5.0L Coyote M-6010-M504VB Block
- Includes "Ford Racing" CM-6731-FL820 Oil Filter and adapter fasteners



2015-2017 5.0L COYOTE OIL LINE ADAPTOR M-6881-M50A

- Fits 2015-2017 5.0L Coyote engines
- Blue anodized billet aluminum oil line adaptor replaces oil filter adapter
- Allows installation of remote mounted oil filter and oil cooler
- Includes two -12 AN (male) fittings & O-rings
- Includes adapter-to-engine block O-ring and mounting bolts

WARNING: Your selection of fittings and filter adapter may restrict oil flow, causing engine damage.



COYOTE MODULAR (CONTINUED)

NEW 2018 5.0L 4V TI-VCT MUSTANG COYOTE CAMSHAFT DRIVE KIT
M-6004-A5018

Camshaft drive kit for the 2018, GEN 3 5.0L Coyote engine

- Fits 2018 5.0L 4V Ti-VCT Mustang Coyote engine

Kit includes new production:

- Tensioner arms
- Chain guides
- Primary and secondary timing chains
- Primary and secondary timing chain tensioners
- Camshaft VCT phasers and bolts
- Forged steel crankshaft sprocket
- Dowel pin and fasteners
- For 2011-2014 see M-6004-A504
- For 2015-2017 see M-6004-A5015



2015-2017 5.0L 4V TI-VCT MUSTANG COYOTE CAMSHAFT DRIVE KIT
M-6004-A5015

Camshaft drive kit for the 2015-2017, Gen 2 5.0L Coyote engine.

- Fits 2015-2017 5.0L 4V Ti-VCT Mustang Coyote engine (For 2011-2014, see M-6004-A504, for 2018 see M-6004-A5018)

Kit includes new production:

- Tensioner arms
- Chain guides
- Primary and secondary timing chains
- Primary and secondary timing chain tensioners
- Camshaft VCT phasers and bolts
- Crankshaft sprocket
- Includes dowel pin and fasteners



2011-2014 5.0L 4V TI-VCT MUSTANG COYOTE CAMSHAFT DRIVE KIT

M-6004-A504

Camshaft drive kit for the 2011-2014 Gen 1 5.0L 4V Ti-VCT Mustang Coyote engine.

- Fits 2011-2014 5.0L 4V Ti-VCT Mustang Coyote engine

Kit includes new production:

- Tensioner arms
- Chain guides
- Primary and secondary timing chains
- BOSS primary timing chain tensioners
- Secondary timing chain tensioners
- Camshaft VCT phasers and bolts
- Crankshaft sprocket
- Includes dowel pin and fasteners

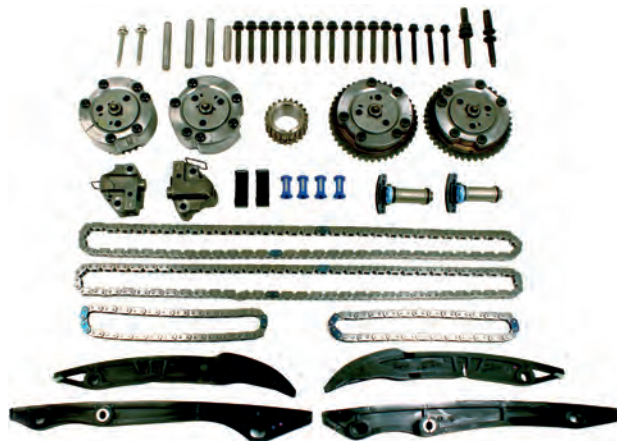

2012-2013 BOSS 302 EXHAUST CAM SET FOR COYOTE 5.0L

M-6550-M50BEXH

- Higher lift and longer duration for increased engine performance
- 13 mm lift/2900 duration (stock 11 mm lift/2630 duration)
- Compatible with M-6049-M50BR and M-6050-M50BR Mustang BOSS 302 cylinder head
- Will work with Mustang GT 5.0L 4V Ti-VCT cylinder head with modification for rocker arm clearance
- Requires use of BOSS 302 M-6513-M50BR Valve Spring Kit
- The cams are used on the 2013 Cobra Jet naturally aspirated engine
- Use with long tube headers for optimum performance gains
- Custom calibration required
- Sold as a pair of camshafts



WARNING: Cancer www.P65Warnings.ca.gov

2012-2013 BOSS 302 INTAKE CAM SET FOR COYOTE 5.0L

M-6550-M50BINT

- Higher lift and longer duration for increased engine performance
- 13 mm lift/2630 duration vs. 12 mm lift/2600 duration on Mustang GT 5.0L engine
- Compatible with M-6049-M50BR and M-6050-M50BR Mustang BOSS 302 Cylinder Head
- Check cam follower roller to cylinder head clearance with base 2011-2014 Mustang GT 5.0L 4V Ti-VCT cylinder head
- Recommend use of BOSS 302 M-6513-M50BR Valve Spring Kit
- The cams are used on the 2013 Cobra Jet naturally aspirated engine
- Custom calibration required
- Sold as a pair of camshafts



WARNING: Cancer www.P65Warnings.ca.gov

GEN 2 COYOTE 5.2L HIGH PERFORMANCE CAMS M-6550-M52

- Intake and exhaust camshaft set for use in the 2015-2017 5.2L cylinder heads with 2015-2017 (Gen 2) 5.0L cam phasers, timing chains and engine control system
- 14 mm lift/2700 duration – intake and exhaust
- Must use the 5.0L Gen 2 cam phasers and chains and crank sprocket
- These cams are to be used with the standard 5.0L Coyote firing order
- Custom calibration required



WARNING: Cancer www.P65Warnings.ca.gov

GEN 1 COYOTE 5.2L HIGH PERFORMANCE CAMS M-6550-M52A

- Intake and exhaust camshaft set for use in the 2015-2017 5.2L cylinder heads with 2011-2014 (Gen 1) 5.0L cam phasers, timing chains and engine control system
- 14 mm lift/2700 duration – intake and exhaust
- Must use the 5.0L Gen 1 cam phasers, timing chains and crank sprocket
- Phasers must be limited to 200 advance maximum via calibration or mechanical limiters
- Must use the 5.2L M-6564-M52 Roller Finger Followers
- These cams are to be used with the standard 5.0L Coyote firing order
- Custom calibration required



WARNING: Cancer www.P65Warnings.ca.gov

NEW 2018 GEN 3 MUSTANG COYOTE 5.0L CYLINDER HEAD

M-6049-M50B Right Hand
M-6050-M50B Left Hand

Production 2018 Mustang GT 5.0L Gen 3 aluminum cylinder head.

Improved flow compared to the 2011-2014 (Gen 1) and 2015-2017 (Gen 2) cylinder heads.

- Finish machined cylinder head is ready to install
- 205 cc intake port volume
- 55.0 cc chamber volume
- 32 mm exhaust valve
- 37.7 mm intake valve
- Includes intake and exhaust valves, valve springs and retainers
- Does not include camshafts, rocker arms or lash adjusters



M-6049-M50B



M-6050-M50B

NOTE: Will not fit 2011-2017 5.0L Coyote engines.

NEW 5.2L GEN 2 CYLINDER HEAD

M-6049-M52A Right Hand
M-6050-M52A Left Hand

Upgraded version of Ford Performance M-6049-M52 5.2L cylinder head.

Improved high-performance 5.2L head castings provide added strength and increased size of central cooling passages, to support higher horsepower engine builds.

- Fully CNC ported intake ports, exhaust ports and combustion chamber
- Larger port sizing than the 2015-2017 5.0L Coyote cylinder heads
- 38.3mm intake valve and 32.5mm exhaust valve
- 2015-2017 5.0L Coyote valve sizes are 37.3mm intake, 31.8mm exhaust
- New valvetrain geometry allows for higher valve lift
- Lightweight hollow-stem intake valves and sodium-filled exhaust valves
- Loaded head assembly minus camshafts, rocker arms and lash adjusters
- To use on 5.0L Coyote requires unique camshaft due to valvetrain geometry, see M-6550-M52 or M-6550-M52A
- Requires 5.2L rocker arms and lash adjusters, see M-6564-M52
- Requires M-6067-M52B head changing kit
- Installation of 5.2L heads on 5.0L engine requires piston modification for proper piston to valve clearance

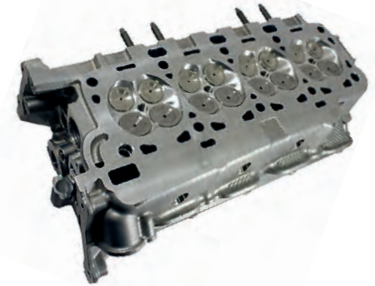

M-6049-M52A



M-6050-M52A

COYOTE 5.2L GT350 CYLINDER HEAD

M-6049-M52 Right Hand (shown)
M-6050-M52 Left Hand

Production cylinder head for the 5.2L GT350.

- Fully CNC-ported intake ports, exhaust ports and combustion chamber
- Larger port sizing than the 2015-2017 5.0L Coyote cylinder heads
- 38.3 mm intake valve and 32.5 mm exhaust valve
- 2015-2017 5.0L Coyote valve sizes are 37.3 mm intake, 31.8 mm exhaust
- New valvetrain geometry allows for higher valve lift
- Lightweight hollow-stem intake valves and sodium-filled exhaust valves
- Loaded head assembly minus camshafts, rocker arms and lash adjusters
- To use on 5.0L Coyote requires unique camshaft due to valvetrain geometry (M-6550-M52 or M-6550-M52A)
- Installation of 5.2L heads on 5.0L engine requires piston modification for proper piston-to-valve clearance
- Requires 5.2L M-6564-M52 Rocker Arms and lash adjusters



COYOTE MODULAR (CONTINUED)

NEW GT350 CYLINDER HEAD SEMI FINISHED

M-6049-M52X Right Hand
M-6050-M52X Left Hand (shown)

Semi Finished GT350 5.2L Coyote Cylinder Head.

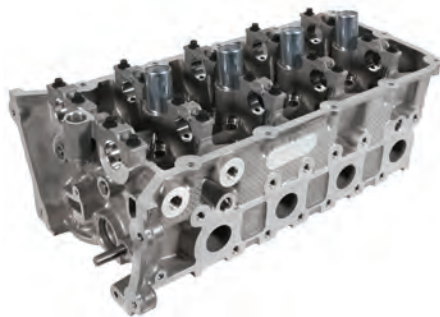

- Requires finish machining and assembly
- CNC intake port machining is deleted
- CNC exhaust port machining is deleted
- Valve guide machining is complete but the valve guides are not installed
- Valve seat insert machining is complete but the seats are not installed
- Includes spark plug tubes, dowels and other hardware

NEW 5.0L / 5.2L COYOTE 12MM LONG HEAD BOLT KIT
M-6067-M501280

- Fits Ford Performance M-6010-M52A 5.2L Coyote Aluminum Engine Block
- Fits 2018 GEN 3 5.0L engines
- These longer (187mm), 12mm head bolts provide greater clamping force than previous 5.0L and 5.2L bolts
- Kit includes 20 high strength torque to yield bolts
- For complete Head Changing Kit for 5.2L applications, see M-6067-M52B



NOTE: Does not fit 2015-2018 5.2L or Ford Performance M-6010-M52 Engine Blocks

NEW 5.2L GEN 2 HEAD CHANGING KIT
M-6067-M52B



Head changing kit allows installation of 5.2L Coyote cylinder heads on 5.2L block – see tech notes below.

- Fits Ford Performance M-6010-M52B GEN 3 and M-6010-M52A GEN 2 5.2L Coyote Aluminum Engine Blocks
- Includes multi-layer steel head gaskets
- Includes increased length, 12mm head bolts provide greater clamping force than previous 5.2L bolts
- Kit includes 20 high strength torque to yield bolts
- 187 mm long



NOTE: Does not fit 2015-2018 5.2L or Ford Performance M-6010-M52 Engine Blocks, see M-6067-M52 (131 mm long)

NEW 2018-2019 5.0L COYOTE HEAD CHANGING KIT – 12MM HEAD BOLTS

M-6067-M5018

- Fits 2018-2019 Mustang 5.0L Coyote cylinder head



Kit includes:

- Multilayer steel head gaskets
- High-strength torque-to-yield 12 mm head bolts

NOTE: 2018 Coyote head gasket is unique and will not interchange with 2011-2017 engines.

2015-2017 5.0L COYOTE HEAD CHANGING KIT – 11 MM HEAD BOLTS

M-6067-M50

- Fits 2015-2017 Mustang 5.0L Coyote cylinder head
- Note that 2015-2017 Coyote head gasket is unique and will not interchange with 2011-2014 engines



Kit includes:

- Multilayer steel head gaskets
- High-strength torque-to-yield 11 mm head bolts

5.0L COYOTE HEAD CHANGING KIT – 5.2L HEAD ON 5.0L BLOCK

M-6067-M5052

This head changing kit is to be used to install the 5.2L GT350 Coyote cylinder head on a standard 2015-2017 5.0L Coyote block.

- Note that 2015-2017 Coyote head gasket is unique and will not interchange with 2013-2014 engines



Kit includes:

- Multilayer steel head gaskets
- High-strength torque-to-yield 11 mm head bolts

BOSS 302R HEAD CHANGING KIT

M-6067-M50BR 12 MM
M-6067-M50BR11 11 MM

- Fits 2012 5.0L BOSS 302R Ti-VCT cylinder head and base 2011-2012 5.0L Ti-VCT cylinder head
- Improved sealing for high cylinder pressure

Kit includes:

- Multilayer steel head gaskets
- High-strength 12 or 11 mm torque-to-yield head bolts



WARNING: Cancer www.P65Warnings.ca.gov

5.2L COYOTE HEAD CHANGING KIT M-6067-M52

Head changing kit allows installation of 5.2L Coyote cylinder head on a 5.2L block:

- Fits Ford Performance M-6010-M52 5.2L Coyote Aluminum Engine Block
- Includes multi-layer steel Left and Right head gaskets
- Includes high strength, torque to yield 12 mm head bolts
- Kit includes 20 head bolts
- 131 mm long

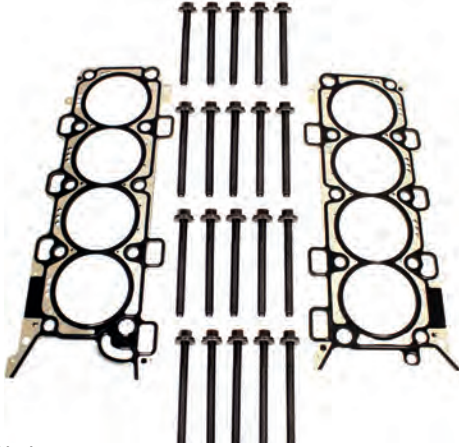

NOTE: Does not fit M-6010-M52A GEN 2 5.2L Coyote Aluminum Engine Block or M-6010-M52B GEN 3 5.2L Coyote Aluminum Engine block, see M-6067-M52B (187 mm long).

NEW 5.0L/5.2L ALUMINUM CAM COVER – PAIR M-6067-M52S

All production camshaft covers include foil tape along the cylinder head mating surface which offer limited protection from exhaust manifold heat; these aluminum camshaft covers allow much greater heat dissipation and protection from exhaust manifold heat.

- Fits 2011-2017 5.0L engines
- Fits 2015-2019 5.2L engines
- Aluminum covers can also be powdercoated to customize your vehicle
- Kit includes camshaft covers, camshaft cover gaskets, VCT solenoid grommets, fasteners
- Retains factory coil cover provisions, F-150 engines will require M-6067B-F150 camshaft cover ball stud kit to install coil covers
- Retains oil separator drain back port which can be used with air/oil separator kits



5.0L COYOTE LASH ADJUSTER ASSEMBLY KIT M-6500-M50

- Fits 2011-2018 5.0L Coyote engines
- Full engine set of 32 camshaft lash adjusters
- Use with M-6564-M50 Follower Kit for 5.0L heads, and M-6564-M52 Follower Kit for 5.2L heads



WARNING: Cancer www.P65Warnings.ca.gov

EXHAUST VALVE LIGHTWEIGHT 5.2L COYOTE – QTY 8 M-6505-M52

- Fits 5.2L Coyote cylinder heads
- Production lightweight exhaust valves
- 32.5 mm diameter
- For reference GEN 2 Coyote is 31.8 mm



INTAKE VALVE LIGHTWEIGHT 5.2L COYOTE – QTY 8 M-6507-M52

- Fits 5.2L Coyote cylinder heads
- Production lightweight intake valves
- 38.3 mm diameter
- For reference GEN 2 Coyote is 37.3 mm



BOSS 302R VALVE SPRING KIT M-6513-M50BR

Valve spring used on 2012-2013 Mustang BOSS 302 engine.

- Higher seat pressure than base valve spring
- 300 N closed 700 N open BOSS 302
- 265 N closed 650 N open Mustang GT
- Installed height 40 mm, same as Mustang GT
- 8000 rpm compatible
- Use with cams up to 13 mm lift
- Can be used on base 5.0L Ti-VCT head
- Sold in sets of 16



5.2L COYOTE VALVE SPRING KIT M-6513-M52

- Fits 5.2L Coyote cylinder heads
- This is the production 5.2L valve spring and hardware
- Will fit not 5.0L Coyote cylinder heads

Kit includes the following:

- 9L8E-6514-AA Valve Spring Retainer – Qty 32
- F53E-6518-AB Valve Spring Retainer Key – Qty 64
- GR3E-6513-AA Intake Valve Spring (Blue) – Qty 16
- GR3E-6513-BA Exhaust Valve Spring (Orange) – Qty 16
- GR3E-6A517-AA Valve Stem Seal – Qty 32



COYOTE MODULAR (CONTINUED)
**5.0L COYOTE ROLLER FINGER FOLLOWER KIT
M-6564-M50**

- Fits 2011-2017 5.0L Coyote engines
- Full engine set of 32 camshaft roller finger followers



WARNING: Cancer www.P65Warnings.ca.gov

**5.2L COYOTE ROLLER FINGER FOLLOWER KIT
M-6564-M52**

- Fits 2015-2017 5.2L Coyote engines
- Full engine set of 32 camshaft roller finger followers



WARNING: Cancer www.P65Warnings.ca.gov

**5.0L COYOTE BOSS 302 TIMING CHAIN TENSIONERS
M-6266-M50B**

- Fits 2011-2019 5.0L Coyote engines
- Designed for improved timing chain durability in high rpm applications
- Used on 2013 Mustang Cobra Jet engine program
- Includes a pair of primary chain tensioners and bolts

**BOSS 302 INTAKE MANIFOLD
M-9424-M50BR**

- Fits 2011-2014 Mustang GT with manual transmission
- Original equipment on Mustang BOSS 302, 302S and 302R race cars
- Made from lightweight composite material
- Short runners for optimum flow at high rpm
- Includes unique "Ford Racing" intake badging
- O-ring intake gaskets included
- M-9444-M50B BOSS 302 Intake Manifold Install Kit is recommended and includes the necessary production components to complete the installation. Minor wiring harness modifications required
- Calibration is necessary to prevent engine damage! Calibration not included!



NOTE: BOSS inlet tube does not have provisions for aspirator tube hook up common to automatic equipped 2011-2014 Mustang GT.

**GT350 5.2L COYOTE INTAKE MANIFOLD
M-9424-M52**

- GT350 intake manifold assembly with Charge Motion Control Valves – CMCV
- Requires GT350 87 mm M-9926-M52 Throttle Body
- Intake is tuned for 7500 rpm peak power



NOTE: Will fit 2015-2019 5.0L Coyote engines. Requires custom calibration. Calibration not included.

**FORD PERFORMANCE COBRA JET 5.0L INTAKE MANIFOLD
M-9424-M50CJA**

The legendary Cobra Jet intake manifold returns with an all-new look! Featuring an all-new lid design, this intake manifold has a new provision to wear the exclusive "Ford Performance" badge proudly.

Developed and based on the naturally aspirated Cobra Jet race car, this intake manifold is one of the most popular modifications to 5.0L Coyote-equipped racers for enthusiasts.

- Fits 2011-2014 Mustang GT with manual transmission and 2012-2013 Mustang BOSS 302
- Fits 2015-2019 Mustang GT with manual transmission and with modifications including but not limited to hood clearancing (modification to stock hood), and/or aftermarket hood and/or lower engine mounts
- Significant power increase over M-9424-M50BR Ford Performance BOSS 302 intake manifold, with no loss of torque
- Made from lightweight composite material
- Runners are tuned for 7750 rpm peak power
- Total intake volume 635 cubic inches
- Designed and tested to 20+ psi
- Intake gaskets included
- Compatible with production Mustang GT 5.0L fuel rail

NOTES:

- Requires Ford Performance throttle body M-9926-CJ65, M-9926-MSVT or M-9926-SCJ
- Requires Ford Performance M-9444-M50B Installation Kit for installation on Mustang GT 5.0L (inlet hose included in installation kit is not used)
- Requires Ford Performance M-9603-M50CJ Cobra Jet Cold Air Kit or equivalent to mate to oval throttle body
- Cobra Jet inlet tube does not have provisions for aspirator tube hook up found on automatic transmission-equipped Mustang GT
- Intake manifold is not compatible with original equipment or Ford Performance strut tower braces
- Nitrous oxide not recommended for use with this intake manifold
- Calibration (not included) is necessary to prevent engine damage!



BOSS 302 INTAKE MANIFOLD INSTALL KIT M-9444-M50B

This kit includes the necessary production Mustang BOSS 302 hardware to complete the installation of M-9424-M50BR Intake Manifold on a 2011-2014 Mustang GT 5.0L 4V Ti-VCT engine.

Kit Includes:

- Fuel vapor hose
- Fuel vapor fuse bracket and fasteners
- Fuel line
- Air inlet tube assembly – throttle body to air-box



NOTE: BOSS inlet tube does not have provisions for aspirator tube hook up common to automatic transmission equipped 2011-2014 Mustang GT.

PERFORMANCE 5.0L COYOTE COLD SPARK PLUG SET M-12405-M50A

- Recommended for use with 2011-2014 Mustang GT 5.0L Coyote M-6066-MGT525D and M-6066-MGT624D Supercharger Kit
- Recommended for use with 2011-2017 Mustang GT vehicles running aftermarket superchargers
- One heat range colder than the stock 2011-2017 Mustang GT 5.0L 4V Ti-VCT engine spark plugs
- As used on the 2016 Cobra Jet engine
- Similar performance to M-12405-M50, but with more robust construction for race applications
- 0.035 plug gap for supercharged applications recommended
- Sold in set of 8



5.0L COYOTE FRONT COVER FOR SUPERCHARGED APPLICATIONS M-6059-M50SC

- Fits 2011-2017 5.0L Coyote engines
- Front cover modified for use with a Ford Performance supercharger



5.0L COYOTE COIL COVER - BOSS 302 M-6067-50B302

- Fits 2012-2013 Mustang BOSS 302
- Fits 2011-2017 Mustang 5.0L 4V Ti-VCT Coyote engine
- Fits 2011-2017 F-150 5.0L 4V Ti-VCT Coyote engine with use of M-6067B-F150
- Fits 2015-2018 Shelby GT350 5.2L
- Premium die-cast aluminum
- Blue powdercoat finish with laser-etched "BOSS 302" logo
- Made in the USA



5.0L COYOTE COIL COVER – FORD PERFORMANCE LOGO M-6067-50FP Black

M-6067-50FP Blue
M-6067-50FPB Black

- Fits 2011-2017 Mustang 5.0L 4V Ti-VCT Coyote engine
- Fits 2011-2017 F-150 5.0L 4V Ti-VCT Coyote engine with use of M-6067B-F150
- Fits 2015-2018 Shelby GT350 5.2L
- Premium die-cast aluminum
- Powdercoat finish with laser-etched "Ford Performance" logo



5.0L COYOTE TIMING/FRONT COVER AND CAM COVER KIT M-6580-M50

This kit provides the front and top end sealing components for 2011-2017 5.0L 4V Ti-VCT Coyote engine build projects.

Kit includes these parts:

- Oil fill cap – Qty 1
- LH crankcase vent fitting – Qty 1
- RH crankcase vent fitting – Qty 1
- Idler pulley – Qty 1
- Idler pulley bolt – Qty 1
- Damper bolt – Qty 1
- Damper washer – Qty 1
- Dipstick and tube – Qty 1
- Cam cover RH – Qty 1
- Cam cover LH – Qty 1
- Front cover – Qty 1
- Front cover bolt & washer – Qty 5
- Front cover stud – Qty 2
- Front main seal – Qty 1
- Water pump and front cover bolt – Qty 8
- M6 x 22 mm oil pan bolt – Qty 4



MUSTANG 5.0L COYOTE COIL COVERS

M-6067-50BK Black Powdercoat
M-6067-50C Chrome

- Fits 2011-2017 Mustang 4V 5.0L Ti-VCT Coyote engine
- Fits 2011-2017 F-150 4V 5.0L Ti-VCT Coyote engine with use of M-6067B-F150
- Fits 2015-2019 Shelby GT350 5.2L
- Premium die-cast aluminum
- Laser-etched "Ford Racing" logo
- Made in the USA



COYOTE MODULAR (CONTINUED)
5.0L COYOTE CAM COVER BALL STUD KIT
M-6067B-F150

- Fits 2011-2017 Coyote engines w/o factory ball studs
- Allows for coil cover attachment on all 2011-2017 5.0 4V F-150 Coyote engines
- OEM quality, steel ball studs
- Kit of 6 ball studs (1 kit required per engine)

5.0L COYOTE "POWERED BY FORD" COIL COVERS
M-6P067-M50B Blue
M-6P067-M50BL Black

- Fits 2011-2017 5.0L Coyote Mustang GT
- Fits 2011-2017 5.0L F-150 4V 5.0L Ti-VCT Coyote engine with use of M-6067B-F150
- Fits 2015-2019 Shelby GT350 5.2L
- "POWERED BY FORD" script
- Made from composite material

BOSS INTAKE MANIFOLD/COYOTE ENGINE DRESS-UP KIT
M-9680-BOSS

Directly from the 2012-2013 Mustang BOSS 302, this kit is designed to finish off the look of any Coyote-powered vehicle equipped with a BOSS 302 intake manifold.

- Fits 2011-2017 Coyote 5.0L Ti-VCT engines
- Cleans up engine bay by covering fuel rail, injectors and wiring
- Foam isolators help to block out injector noise while dressing up engine bay
- OEM parts off of 2012-2013 BOSS 302 Mustang

Kit includes:

- Driver-side isolator
- Passenger-side isolator
- Purge canister (PCV) bracket
- Hardware

2011-2014 5.0L COYOTE GEN 1 ENGINE COVER KIT
M-9680-M50

Original equipment on manual transmission 2011-2014 Mustang GT 5.0L Ti-VCT Coyote engine.

- Intake cover includes "5.0" emblem and "32V Ti-VCT" script
- Coil covers include "POWERED BY FORD" script
- Perfect add-on for 2011-2014 5.0L Ti-VCT Coyote crate engine install

2015-2017 MUSTANG GT COYOTE ENGINE COVER KIT
M-9680-M50A

- Original equipment on manual transmission 2015-2017 Mustang GT 5.0L 4V Ti-VCT Coyote engine
- Intake cover includes "5.0" emblem
- Coil covers include "POWERED BY FORD" script
- Both covers are molded in silver/gray
- Perfect add-on for all Mustang and other cars powered by the 5.0L 4V Ti-VCT Coyote M-6007-M50A and M-6007-M50AAUTO Crate Engine

NOTE: Does not include strut tower brace shown in part image.

HIGH-TORQUE MINI STARTER – COYOTE & MODULAR ENGINES
M-11000-C50

- Fits 5.0L Coyote, 4.6L, 5.4L and 5.8L modular RWD with automatic and manual transmissions
- Compact construction, great for header clearance
- Weighs approximately 6 lbs
- Comes with starter cables
- Must use diode protected fenderwell solenoid when used in non-production applications. Call the Ford Performance Techline at (800)367-3788 for more details



NOTE: Does not work with 6R80 or 10R80 transmissions

EARLY 5.0L COYOTE ENGINE IGNITION COIL SET (8)
M-12029-M50C

- Fits all 2011-2/23/16 Mustang GT and F-150 5.0L 4V Ti-VCT Coyote engines
- This is a set of 8 OEM production ignition coils and bolts for a 5.0L Coyote engine

NOTE: Does not fit engines built after 2/23/16 due to electrical connector change, including crate engines



LATE 5.0L COYOTE ENGINE IGNITION COIL SET (8)
M-12029-M50E

- Fits all 2/24/16 and later-built Mustang GT and F-150 5.0L 4V Ti-VCT Coyote engines. For vehicles and harnesses built prior to 2/24/16, see Part No. M-12029-M50C
- This is a set of 8 OEM production ignition coils and bolts for a 5.0L Coyote engine



NOTE: Does not fit engines built 2/23/16 and prior due to electrical connector change, including crate engines. These coils only work with the latest level wiring harness (GR3T prefix).

5.0L COYOTE HIGH RPM COMPETITION PULSE RING
M-12A227-CJ13

- Fits 2011-2017 5.0L Coyote engines
- Ignition pulse ring modified to support higher rpm engine builds
- Extends rpm range from 7700 to 8100 rpm
- Developed for the 2013 Cobra Jet program



5.0L COYOTE AUTOMATIC TRANSMISSION FLEXPATE AND BOLTS
M-6375-A50C

- Production automatic transmission flexplate for the Mustang 5.0L Coyote with 6R80 transmission
- Includes 8 one-time use torque-to-yield flexplate to crankshaft bolts



- Replacement bolts also available – M-6379-M50A

MUSTANG BOSS 302 ALTERNATOR KIT
M-8600-M50BALT

This kit includes special high-performance components as used on the production 2012-2013 Mustang BOSS 302 and is designed to operate at higher rpm.

This kit fits Mustang 5.0L Coyote engine and features:

- High-performance BOSS Alternator with 1-way clutch to prevent belt hop-off during upshifts
- Higher tension belt tensioner
- Larger pulley to slow the armature speed, reduce drag and reduce parasitic hp loss
- Also fits M-6007-M50A, M-6007-M50AAUTO, M-6007-A50NAA, M-6007-A50SCA and M-6007-A50XS Ford Performance crate engines
- Kit includes OEM Mustang BOSS 302 alternator, tensioner, idler pulley, belt and mounting hardware



HIGH OUTPUT ALTERNATOR KIT COYOTE 5.0L
M-8600-M50ALTA

This kit includes special high output alternator used on 2018-2019 Mustang GT with heated/cooled seats. This kit fits Mustang 5.0L Coyote engine and features:

- High-output Mustang GT Alternator
- Higher tension belt tensioner
- 200 amp output
- Also fits M-6007-M50A, M-6007-M50C, M-6007-M50AAUTO, M-6007-M50CAUTO, M-6007-A50NAA, M-6007-A50NAB, M-6007-A50SCA, M-6007-A50SCB Ford Performance crate engines
- Kit includes OEM high output Mustang GT alternator, tensioner, idler pulley, belt and mounting hardware



ELECTRIC WATER PUMP KIT FOR COYOTE 5.0L
M-8501-M50CJ16

- As used on 2016 Cobra Jet race car

Kit includes:

- Electric water pump
- Wiring pigtail for pump
- Block side outlet plate
- Requires custom hoses and mounting bracket for installation
- For off-road use only



HIGH PERFORMANCE INTERCOOLER PUMP KIT – COBRA JET – GT500
M-8501-M58

- Ideal for high-performance supercharged applications using air-to-liquid intercooler
- Original equipment on 2016 Cobra Jet race car and 2013-2014 GT500
- Kit includes pump, wiring pigtail, mounting bracket and fasteners



MUSTANG SHELBY GT500 INTERCOOLER PUMP
M-8501-MSVT

- Production 2007-2012 Mustang Shelby GT500 intercooler coolant circulation pump
- Used to circulate water through supercharger intercooler and heat exchanger
- Inlet and outlet hose connection diameter is 19 mm / 3/4"
- Can be used in many coolant pumping applications
- Includes rubber isolated mounting bracket



COYOTE MODULAR (CONTINUED)
NEW 2011-2019 5.0L / 5.2L COYOTE 4-BOLT WATER PUMP M-8501-M50

Replacement water pump kit for 2011-2018 5.0L and 2015-2018 5.2L engines. Pump kit is comprised of OEM components with minimum allowable tolerances to promote longevity. This kit is only available for a limited time!

Includes:

- Water pump
- Water pump pulley
- Attachment hardware (4 bolt pulley-to-pump attachment)
- As used on previous Ford Performance "Aluminator" engine builds.

NEW 5.2L GEN 2 WATER PUMP KIT M-8501-M52A

Performance water pump kit for 2011-2019 5.0L and 2015-2019 5.2L engines. Pump delivers 30% improvement in flow over standard pump. Kit is comprised of OEM components with minimum allowable tolerances to promote longevity. Includes:



- Water Pump
- Water Pump Pulley
- Attachment Hardware (4 bolt pulley-to-pump attachment)

BOSS 302R 5.0L POWER STEERING PUMP BRACKET M-8511-M50BR

- Bracket allows power steering pump to be mounted to 2011-2017 5.0L Coyote engine
- Allows power steering pump from 2005-2010 Mustang GT to be used
- Power steering pump mounts in position of factory A/C compressor

5.0L COYOTE AIR CONDITIONING KIT M-8600-M50AC

This kit includes 2015-2017 Mustang GT AC compressor, lines and drive belt for custom engine installations.

Fits 2011-2017 5.0L 4V Ti-VCT Coyote engines and 2015-2017 Mustang GT

Kit includes:

- A/C compressor
- A/C compressor clutch/pulley
- 5.0L FEAD belt
- A/C high-pressure line
- A/C low-pressure line
- Fasteners

2005-2014 MUSTANG PERFORMANCE COOLING FAN M-8C607-MSVT

- Fits 2005-2014 Mustang GT and 2007-2014 Mustang Shelby GT500
- Original equipment cooling fan on 2013-2014 Mustang Shelby GT500
- Added cooling capacity for performance applications

NEW 5.0L COYOTE HIGH STRENGTH VCT SOLENOIDS M-6297-M50A

With a stronger mounting provision, these variable cam timing (VCT) solenoids are more robust for racing applications and offer increased strength over OEM solenoids for the following applications:

- Fits 2011-2017 5.0L Mustang engines
- Fits 2011-2017 5.0L F-150 engines
- Fits 2015-2018 5.2L Mustang GT350 engines
- Includes four solenoids per kit

NEW 5.2L CYLINDER HEAD VALVE TRAIN KIT M-6505-FP350S

Comprehensive cylinder head valve train kit which provides robust upgrades to 5.2L cylinder heads. These components were fully developed for and used on Ford Performance FP350S road race car, capable of race duty, and 8,250 rpm.

Includes:

- 16 Solid steel, 1.51 in intake valves
- 16 Solid steel, 1.28 in exhaust valves
- 32 Stiffer, unique valve springs from PAC®
- 64 Valve spring keepers/keys
- 32 Titanium valve spring retainers
- 32 Valve stem seals



NOTE: Titanium valve spring retainers require routine replacement, normally after after each race season.

NEW 5.2L OIL SQUIRTER BLOCK OFF KIT M-6868-M50

These oil squirter block-off plugs are typically used in race applications such as drag racing, where the reduction of engine oil windage can be a competitive advantage when piston temperatures are maintained.

- Fits 2015-2019 5.2L engine blocks
- Set of eight, complete for one engine block



MODULAR AND COMPONENTS

5.3L MODULAR STROKER SHORT BLOCK

M-6009-B53

Build BIG modular power. The Ford Performance 5.3L Modular Stroker short block is a great way to build modular power – from mild to wild – naturally aspirated or supercharged – 2-valve, 3-valve or 4-valve.

Ford Performance engineers have taken care of the toughest part of building a new engine by designing a strong and durable short block that offers a wide range of power possibilities. Ford Performance uses only its best parts, starting with the BOSS modular block, and adding forged Eagle® steel crankshaft, forged Eagle® H-beam connecting rods with floating piston pins, and forged Mahle® pistons. Bored and stroked to 5.3 liters, this short block is precision internal balanced and ready to be finished to your specific application.

- Engine type: 4.6L based modular short block
- Displacement: 5.3L/323 cubic inches
- Bore x stroke: 3.701" bore x 3.750" stroke
- Block: Ford Performance M-6010-BOSS50 Cast Iron Performance Block
- Crankshaft: Eagle® 3.750" stroke forged steel crankshaft with 8-bolt flywheel pattern
- Connecting rods: Eagle® 5.850" forged steel H-beam rods with ARP® 2000 bolts
- Pistons: Mahle® forged aluminum pistons with a dish that is compatible with 2-, 3- or 4-valve heads
- New high-pressure oil pump
- Neutral balance rotating assembly
- Designed for 2-, 3- or 4-valve cylinder head combinations (piston-to-valve check required depending on camshaft)
- Assembled and ready for your heads, cam and timing set

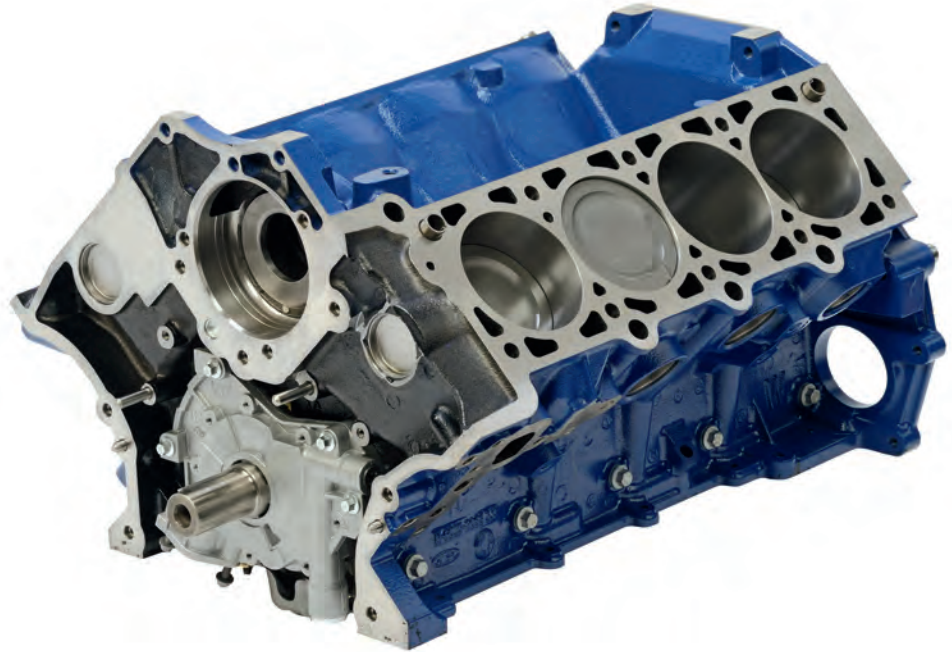

NOTE: 2005-2010 Mustang 3V applications will need motor mount adapter Part No. M-6031-BOSS50.

WARNING: Cancer www.P65Warnings.ca.gov

5.0L CAST IRON MODULAR BOSS ENGINE BLOCK

M-6010-BOSS50

The BOSS 5.0 block is a 4.6L deck height, 94 mm cylinder bore cast iron block. The block uses a proprietary iron mix to yield the strongest possible casting strength with the least porosity and greatest consistency.

NOTE: The BOSS 5.0L modular block does not have a finish milled head deck surface and the cylinder bores are rough honed.

- Siamese 94 mm bore
- 17 mm main web minimal thickness
- 4-bolt main with interference fit nodular iron-machined caps
- Increased main web window size for improved crankcase breathing
- Head gaskets for 3V applications use M-6067-3V50; for all others, contact Cometic® Gasket
- For installation in 2005-2010 Mustang, use M-6031-BOSS50 Engine Mount Brackets
- Weighs approximately 165 lbs

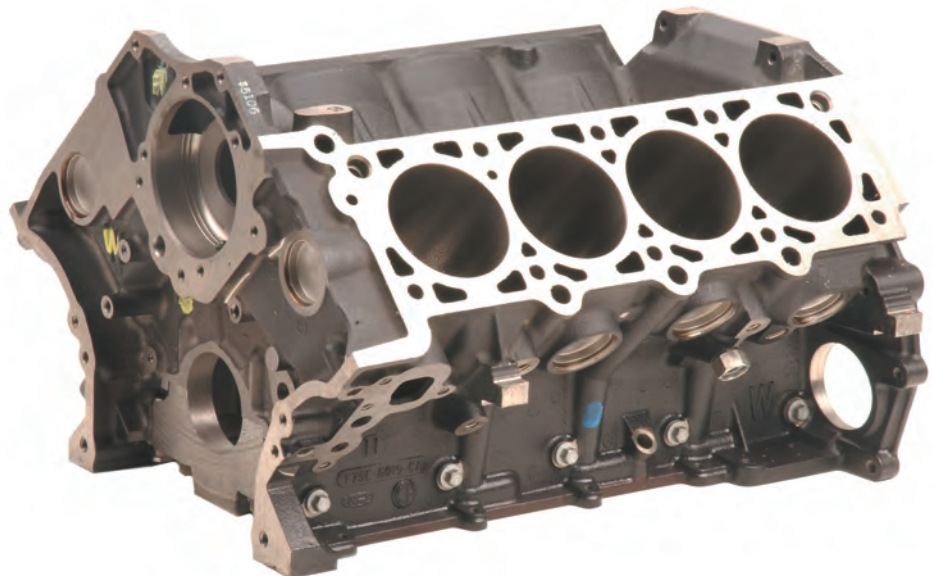

MODULAR AND COMPONENTS (CONTINUED)
ENGINE MOUNT BRACKET KIT
M-6031-BOSS50

Designed to install the M-6010-BOSS50 Block in a 2005-2010 Mustang.

Kit includes:

- Aluminum engine mounting brackets
- Adapter plates
- Hardware

4.6 LITER ALUMINUM BLOCK PLUG AND DOWEL KIT
M-6026-A46

Kit includes all necessary dowels, drain plugs and cup plugs for rebuilding a production 4.6L aluminum block.

Kit includes:

- 376099-S Plug Cup .075" – Qty 4
- 391186-S101 Threaded Drain Plug – Qty 2
- F75E-18B402-AA Water Heater Tube – Qty 1
- N806435-S Cup Plug – Qty 1
- N807198-SMOD Shortened Dowel N807198-S – Qty 2
- N808315-S Cup Plug (38.3 DIA) – Qty 1
- W701228-S Front/Rear Cover Dowels – Qty 4
- W704594-S300 Cylinder Head Dowels – Qty 4

PLUG AND DOWEL KIT
M-6026-C146

Kit includes all necessary dowels, drain plugs and cup plugs for rebuilding M-6010-BOSS50 and M-6010-D46 Block.

- 391186-S101 Threaded Drain Plug – Qty 2
- F75E-18B402-AA Water Heater Tube – Qty 1
- N806040-S Solid Dowels – Qty 2
- N806435-S Cup Plug – Qty 2
- N807198-SMOD Shortened Dowel N807198-S – Qty 2
- N807198-S Transmission Dowel – Qty 1
- N808315-S Cup Plug (38.3 DIA) – Qty 10
- W701228-S Front/Rear Cover Dowels – Qty 4
- W704594-S300 Cylinder Head Dowels – Qty 4

4.6L 3V ALUMINUM BLOCK MAIN CAP BOLT KIT
M-6345-A46

Fits 2005-2010 4.6L 3V aluminum cylinder blocks and M-6010-A46NA Ford Performance block.

Kit contains all main bolts for one block.

Kit includes:

- M9 x 32 mm cross bolts – Qty 10
- M10 x 102.5 mm main cap inner w/stud bolts – Qty 10
- M8 x 80 mm main cap outer bolts – Qty 10
- M10 x 91 mm main cap inner bolts – Qty 6
- Bolts are torque-to-yield and must be replaced after each use

4.6L HIGH VOLUME OIL PUMP AND PICKUP TUBE
M-6600-D46

- Fits 1996-2004 Mustang 4.6L 2V
- Stock replacement oil pump and pickup tube for 1996-2004 Mustang SVT 4.6L 4V
- Increases flow on 4.6L 2V engines

4.6L 2V CAMSHAFT DRIVE KIT
M-6004-462V

Camshaft drive kit for the 4.6L 2-valve aluminum or cast iron block.

- Fits 2001 and newer 4.6L 2V engines
- Will fit earlier 2V engines (1991-2000), requires RH chain guide dowel pin hole to be drilled and tapped for a reducing thread insert with 6M x 1.00 internal threads

Kit includes new production:

- Tensioner arms
- Chain guides
- Cover gaskets and front seal
- Primary timing chains
- Chain tensioners
- Camshaft sprockets, spacers, bolts and washers
- Crankshaft sprocket
- Crank position trigger wheel
- Includes fasteners



4.6L 3V CAMSHAFT DRIVE KIT M-6004-463V

Camshaft drive kit for the 4.6L 3V aluminum and iron block.

- Fits 2005-2010 engines

Kit includes new production:

- Tensioner arms
- Chain guides
- Cover gaskets and front seal
- Primary timing chains
- Primary chain tensioners
- Camshaft sprockets, spacers, bolts and washers
- Crankshaft sprocket
- Crank position trigger wheel
- Includes fasteners



4.6L 4V CAMSHAFT DRIVE KIT M-6004-A464

Camshaft drive kit for the 4.6L 4-valve aluminum block.

- Fits 1996-2004 4.6L 4V engines
- Will not fit 1993-1998 camshafts

Kit includes new production:

- Tensioner arms
- Chain guides
- Front cover gaskets and front main seal
- Primary and secondary timing chains
- Primary and secondary timing chain tensioners
- Camshaft sprockets, spacers, bolts and washers
- Crankshaft sprocket
- Crank position trigger wheel
- Includes fasteners



5.4L 4V MUSTANG SVT CAMSHAFT DRIVE KIT M-6004-54SVT

Camshaft drive kit for the Mustang SVT 5.4L 4-valve engine with an aluminum or cast iron block.

- Fits: 2007-2013 5.4L 4V Shelby GT500
- Includes reduced diameter camshaft sprockets used on Shelby GT500

Kit includes new production:

- Tensioner arms
- Chain guides
- Primary and secondary timing chains
- Primary and secondary timing chain tensioner
- Camshaft sprockets, spacers, bolts and washers
- Crankshaft sprocket and diamond-coated washer
- Crank position trigger wheel
- Includes fasteners

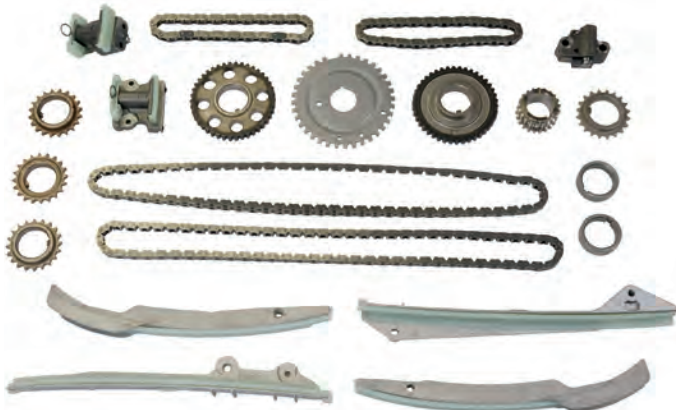

5.4L 4V CAMSHAFT DRIVE KIT M-6004-A544

Camshaft drive kit for the 5.4L 4V. Standard equipment on Ford GT 5.4L 4V engine. Recommended for high horsepower and/or high rpm applications.

- Fits both 5.4L 4V aluminum and cast iron block engines
- Larger diameter cam gears not compatible with Shelby GT500 cam covers

Kit includes new production:

- Tensioner arms
- Chain guides
- Primary and secondary timing chains
- Primary and secondary composite timing chain tensioners
- Camshaft sprockets, spacers, bolts and washers
- Crankshaft sprocket and diamond-coated washer
- Crank position trigger wheel
- Includes fasteners

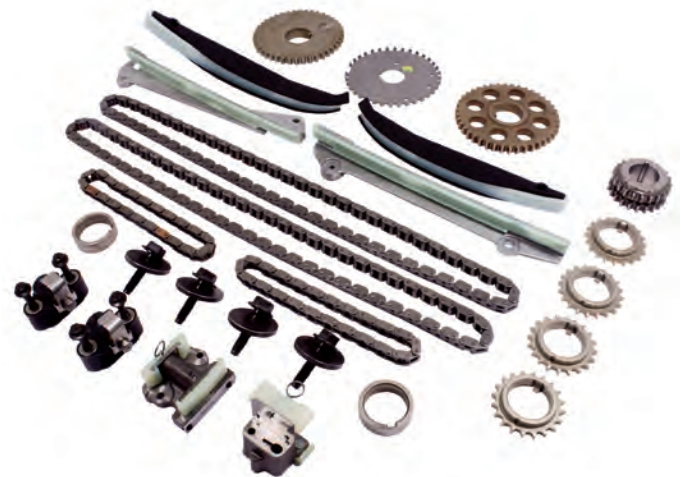

MODULAR AND COMPONENTS (CONTINUED)

5.4L/5.8L TIMING COVER FOR S/C APPLICATIONS M-6059-MSK

5.4L and 5.8L front timing cover for supercharged applications.

- Fits 2007-2014 Mustang GT500

Includes:

- 5.4L/5.8L front timing cover
- 5.4L/5.8L front crankshaft seal
- Attachment hardware



4.6L 3V HEAD CHANGING KIT M-6067-3V46

- Fits 4.6L 3V modular engine with standard 90.2 mm bore
- Highly recommended when installing M-6049-N3VPA and M-6050-N3VPA CNC ported cylinder heads and M-6049-N3V and M-6050-N3V production cylinder heads
- Kit includes multilayer steel head gaskets and high-strength torque-to-yield cylinder head bolts



5.0L 3V HEAD CHANGING KIT M-6067-3V50

- Fits M-6010-BOSS50 5.0L modular engine block with 94 mm bore and 3V cylinder heads
- Kit includes multilayer steel head gaskets and high-strength torque-to-yield head bolts



4.6L 2V SOHC HEAD CHANGING KIT M-6067-D46

Contains all components necessary for changing cylinder heads on 1996-2004 Mustang 4.6L 2V SOHC engine (may fit other make and model years 4.6L 2V SOHC engines)

- Kit includes multilayer steel head gaskets, exhaust manifold gaskets and high-strength torque-to-yield head bolts
- Includes spacers that make this task significantly easier to remove and replace heads while on the car
- Highly recommended when installing M-6049-P46 and M-6050-P46 cylinder heads



5.8L 4V S/C HEAD CHANGING KIT M-6067-M58

- Fits 2013-2014 Mustang Shelby GT500 5.8L 4V engine
- Kit includes multilayer steel head gasket and torque-to-yield head bolts
- Improved sealing for high cylinder pressure applications

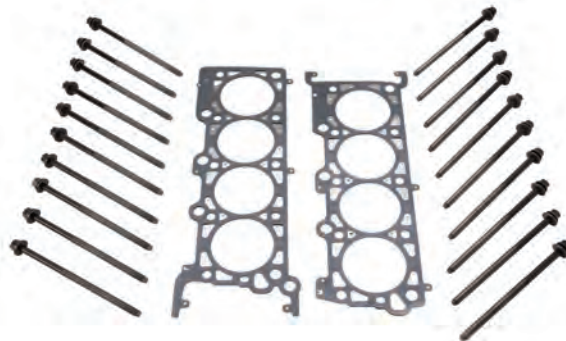

5.4L 4V S/C HEAD CHANGING KIT M-6067-MSVT

- Fits 5.4L DOHC engines
- Original equipment on 2007-2011 Mustang SVT and 2008 Mustang FR500CJ race car
- Improved sealing for high cylinder pressure applications
- Kit includes multilayer steel head gaskets and high-strength torque-to-yield head bolts

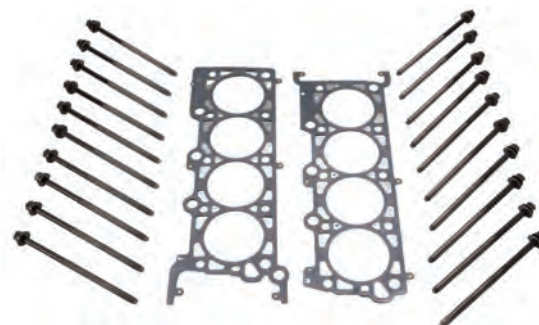

4.6L 4V HEAD CHANGING KIT

M-6067-T46

Contains all components necessary for changing cylinder heads on 1996-2004 4.6L 4V Mustang naturally aspirated engines (not supercharged)

- Kit includes multilayer steel head gaskets and high-strength torque-to-yield head bolts
- Includes spacers that make this task significantly easier to remove and replace heads while on the car
- Highly recommended when installing heads on 4.6L 4V



5.4L 4V STEEL TIMING CHAIN TENSIONER KIT

M-6266-54ST

- Fits 5.4L 4V engines
- Production steel primary right and left timing chain tensioners
- Includes Part No. F6AZ-6L266-DA and F6AZ-6L266-CA (1 of each Part No.)
- 1 kit required per engine



4.6L 3V CAMSHAFT BOLT

M-6279-463V

- Fits 2005-2010 4.6L 3V engines
- Kit includes two (2) bolts
- Torque-to-yield design

Torque information:

- Stage 1: Tighten to 40 Nm (30 lb-ft)
- Stage 2: Tighten an additional 90°



FORD GT AND 5.4L GT500 LASH ADJUSTERS

M-6500-GT

- Unique lash adjusters fit Ford GT and Mustang SVT 5.4L DOHC cylinder heads
- Includes 16 intake and 16 exhaust lash adjusters



MODULAR 3V ROCKER ARM AND LASH ADJUSTER KIT

M-6529-3V

- Fits 4.6L 3V cylinder heads
- Original production part as used on 2005-2010 Mustang GT
- Sold in engine sets (24 rocker arms and 24 lash adjusters)



MUSTANG SVT 5.4L MODULAR ROCKER ARM SET

M-6529-MSVT

- Original equipment on Ford GT 5.4L engine
- Recommended upgrade for all years 4.6L/5.4L, 4V and 2V engines
- 4 grams lighter, stiffer, and better engagement on lash adjuster over 4.6L DOHC rocker arms
- Lightest and strongest modular finger follower available for modular 4.6L/5.4L, 4V and 2V engines
- Sold in a set of 16



MODULAR AND COMPONENTS (CONTINUED)

2005-2010 MUSTANG GT HIGH LIFT HOT ROD CAM SET M-6550-3V

Give any 3-valve 4.6L or 5.4L a “lopey” idle reminiscent of 1960s muscle cars!

- Engineered for naturally aspirated and supercharged applications
- Excellent upgrade for the 2005-2010 Mustang GT 4.6L 3V engine
- Increases lift from the stock 11 mm/0.433" to 12 mm/0.472"
- Intake/exhaust duration of 2210/2400 (@ 0.050" lift), lobe separation of 1100
- Compatible with production valve springs, followers and lash adjusters up to 6800 rpm
- Must be used with long tube headers to achieve a significant power gain
- M-9424-463V 4.6L High-flow Intake and M-9926-3V Throttle Body recommended
- Works well with Ford Performance M-9926-3V 62 mm Throttle Body, M-9424-463V 4.6L High-flow Intake and ported cylinder heads
- Approximately 50 hp gain with the stock intake manifold and Ford Performance M-6049-N3VOA/M-6050-N3VPA CNC heads at 6500 rpm. These cylinder heads are for reference only, and no longer produced by Ford Performance
- **Custom Calibration required! Calibration not included!** Recommended WOT cam timing values included in instructions



WARNING: Cancer www.P65Warnings.ca.gov

4.6L 3V PERFORMANCE INTAKE MANIFOLD M-9424-463V

- Fits 2005-2010 4.6L 3V Mustang engines
- Works well with Ford Performance M-6550-3V Hot Rod Camshafts, M-6049-N3VPA High-Performance CNC-Ported 3V Cylinder Heads and Ford Performance M-9926-3V 62 mm Throttle Body
- Lightweight composite construction (same material as OE intake manifold)
- Manifold works well with forced induction
- Designed and tested to 20+ psi
- Less heat soak than aluminum intakes
- High-flow runners and open plenum design, fits under factory Mustang hood
- MAP sensor mounting boss for speed-density applications
- Includes intake manifold gaskets
- **Calibration required! Calibration not included!**
- Does not fit with Ford Performance strut tower braces



NOTE: Throttle body not included.

1996-2010 MUSTANG A/C ELIMINATOR KIT M-19216-D46

- Fits 1996-2010 Mustang with 4.6L SOHC/DOHC engines
- Cast aluminum idler pulley bracket replaces the air conditioning compressor
- For 1994-1995 Mustang and 1991-1993 Thunderbird with 5.0L engine, see M-19216-A50
- Removes weight from the front of car for better weight distribution for racing
- Bolts included
- Uses stock belt



4.6L PERFORMANCE IMPROVEMENT (PI) INTAKE MANIFOLD M-9424-P46

- Production composite intake manifold used on 2001-2004 4.6L SOHC 2V Mustang GT
- Manifold fits 1999-2004 performance improvement (PI) head ports
- For off-road use only; can be used on 1996-1998 engines with performance improvement (PI) heads, custom calibration required
- Additional modifications and parts required
- Requires 4C3Z-9439-CA Intake Gasket Set available from your local Ford dealer

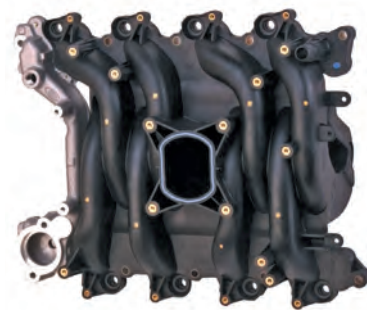

EXHAUST MANIFOLD GASKETS RACE QUALITY (SOLD IN PAIRS)

PART NUMBER	CYLINDER HEAD APPLICATION
M-9448-A462	4.6L SOHC
M-9448-A463V	4.6L/5.4L 3V
M-9448-A464	4.6L DOHC



M-9448-A462



M-9448-A463V

M-9448-A464

9MM SPARK PLUG WIRE SETS - "FORD RACING"

Wire-wound custom ignition wire sets feature low resistance for minimum spark loss. Silicone insulation and boots withstand high temperatures and voltage loss for minimum cross-fire and are highly resistant to fuels, oils and solvents. Long-life, tough stainless steel terminals for post-type distributor caps.

Includes coil wire for socket-type coil and "Ford Racing" identification. Cylinder number appears on each wire.

Spark plug wires feature high-quality 9 mm wire available in two colors: blue and red.

PART NUMBER	APPLICATION	WIRE COLOR	END CONFIG
M-12259-C462	4.6L 2V Mustang	Blue	45° Long Boot
M-12259-C464	4.6L 4V Mustang	Blue	45° Long Boot
M-12259-R462	4.6L 2V Mustang	Red	45° Long Boot
M-12259-R464	4.6L 4V Mustang	Red	45° Long Boot
M-12259-T462	4.6L 2V F-150 Truck	Blue	45° Long Boot



M-12259-R462/Mustang 4.6L SOHC 9 mm Wire Set



M-12259-C464/Mustang 4.6L SOHC 9 mm Wire Set

4.6L/5.4L 3V IGNITION COIL SET M-12029-3V

- Fits Mustang 4.6L and 5.4L 3V engines with 12 mm spark plugs. Does not fit 3V heads with "High Thread" design spark plugs
- Direct replacement for 4.6L and 5.4L 3V engines equipped with 8L3E coils
- Required when installing Ford Performance heads M-6049-463VP3, M-6049-N3V, M-6049-N3VPA and M-6050-463VP3, M-6050-N3V, M-6050-N3VPA on 2005-2007 and early 2008 Mustang GT originally equipped with "High Thread" design heads
- Engines with late-style 12 mm spark plugs can be identified by coil engineering number 8L3E. Engines with early-style 16 mm "High Thread" design spark plugs can be identified by coil engineering number 3L3E
- One engine set of stock replacement coils



2007-2014 MUSTANG SVT 4V IGNITION COIL SET M-12029-4V



- Fits 2007-2012 Shelby GT500 5.4L DOHC and 2013-2014 Shelby GT500 5.8L DOHC
- One engine set of stock replacement coils



3V COLD SPARK PLUG SET (12 MM THREAD) M-12405-3V12MM

- Fits 2008 and newer 3V heads requiring the 12 mm thread
- For use in engines with higher than stock cylinder combustion pressures or sustained high rpm
- One heat range colder than the stock Mustang GT and 5.4L 3V truck engine spark plugs
- Sold in engine sets of 8
- Use M-12405-3V0 Spark Plugs for early-style 2005-2008 3V heads



NOTES:

- 2008 engines with late-style 12 mm spark plugs can be identified by coil engineering number 8L3E.
- 2005-2008 engines with early-style 16 mm "High Thread" design spark plugs can be identified by coil engineering number 3L3E.
- All 2009-2010 engines use 12 mm spark plugs.

MODULAR AND COMPONENTS (CONTINUED)
3V COLD SPARK PLUG (16 MM THREAD)
M-12405-3V0A

- This part supersedes Ford Performance M-12405-3V0
- Fits 2005-2008 3V heads requiring the 16 mm thread
- For use in engines with higher-than-stock cylinder combustion pressures or sustained high rpm
- Unique design is proprietary to Ford 3-valve engines
- One heat range colder than the stock Mustang GT plug
- Two heat ranges colder than the stock 5.4L 3V truck engine plug
- Sold in sets of 8
- Use M-12405-3V12MM spark plugs for 2008 and newer 3V heads



NOTE: 2008 engines with late style 12 mm spark plugs can be identified by coil engineering number 8L3E.

NOTE: 2005-2008 engines with early style 16 mm "high thread" design spark plugs can be identified by coil engineering number 3L3E part number.

NOTE: All 2009-2010 engines use 12 mm spark plugs.

2007-2014 MUSTANG SVT COIL COVERS
M-6067-C

- Original equipment on the 2007-2014 Mustang SVT
- Fits most 4.6L/5.4L/5.8L DOHC engines with coil-on-plug ignition

4.6L/5.4L 4V "FORD RACING" CAST COIL COVERS
M-6067-D

- Fits most 4.6L/5.4L DOHC engines with coil-on-plug ignition
- Polished die-cast aluminum
- Features two-color "Ford Racing" logo

"FORD RACING" COATED 3-VALVE CAM COVERS
M-6582-FR3VBL Blue Powdercoated
M-6582-FR3VBLK Black Powdercoated

- Fits 2005-2010 3-valve 4.6L/5.4L engines
- Die-cast
- Powdercoat finish
- Laser-etched "Ford Racing" logo
- Includes cam cover gaskets, VCT solenoid grommet and fasteners
- 50-state street legal when installed with appropriate closed PCV hardware

2005-2010 MUSTANG GT INTAKE SHROUD
M-6949-3V

- Original equipment on 2007-2010 Mustang GT
- Fits 2005-2010 Mustang GT
- May require 2007 Mustang throttle body studs (W712289 S437) and nuts (W520411 S437) from Ford dealer
- Will not fit with Ford Performance M-20201-S197 Strut Tower Brace or with Ford Performance superchargers



NEW 2.3L 310HP MUSTANG ECOBOOST® ENGINE KIT
M-6007-23TA*

Ford Performance offers the high tech, 2018 Mustang 2.3L EcoBoost® turbocharged engine as a crate engine kit.

With turbocharging, direct injection and twin independent variable cam timing (Ti-VCT), this kind of performance comes standard with a dose of adrenaline.

The swap possibilities are almost endless; from early street rods, kit cars, most generations of Mustang, to just about any other vehicle build.

The Ford Performance Control Pack helps make for an easy plug-and-play installation (available separately).

- 2.3L EcoBoost® engine as used in the 2018 Mustang
- 310HP/350 lb.-ft. Torque @ 3,000 rpm (with 93 octane fuel)
- Designed for traditional rear drive installations

Engine kit includes:

- Engine
- Production turbocharger
- Starter and mounting hardware
- Alternator and mounting hardware
- Engine harness (not installed, must be used with Ford Performance Control Pack)
- Throttle body (not installed, must be used with Ford Performance Control Pack)
- Engine kit uses Ford Performance M-6017-23T Control Pack (not included)



*This component is eligible for the Ford Performance Parts Limited Warranty. See the Ford Performance Parts Limited Warranty on pages 217-225 for details.

ECOBOOST® (CONTINUED)

2.3L ECOBOOST® MUSTANG ENGINE BLOCK M-6010-23T

- Production Mustang 2.3L EcoBoost® cylinder block
- Includes plugs, dowels and other production hardware for buildup

Also available for an EcoBoost® engine build are:

- M-6303-23EB 2.3L EcoBoost® Crankshaft
- M-6049-M23 2.3L Mustang EcoBoost® Cylinder Head



2015-2018 MUSTANG 2.3L ECOBOOST® CYLINDER HEAD M-6049-M23

- Fits 2015-2018 Mustang EcoBoost® engines
- This is the production IEP (integrated exhaust port) cylinder head
- Includes water jacket plugs and valve seals
- Does not include valves, valve springs, retainers, valve locks or tappets
- Same cylinder head used in Brad Gusler's NMRA 1/4 mile record setting EcoBoost® Mustang



2.3L ECOBOOST® BALANCE SHAFT BLOCK-OFF PLUG M-6026-23BSBP

- Fits 2.0L and 2.3L EcoBoost® engines
- Allows for removal of the balance shaft
- 20 lb decrease in rotating mass in the engine
- Increases oil volume to the upper end of the engine



2015-2018 2.3L ECOBOOST® HIGH PERFORMANCE CAMS M-6250-23EBH

- Fits 2015-2018 Mustang 2.3L EcoBoost® engines
- These cams provide more lift and duration
- Intake cam lift increased from 7.9 mm to 9.0 mm and duration increased 4° to 240° (total degrees)
- Exhaust cam lift increased from 7.4 mm to 7.8 mm and duration increased 16° to 240° (total degrees)
- Cams will work with stock pistons
- No valve spring change is required



WARNING: Cancer www.P65Warnings.ca.gov

2015-2018 2.3L ECOBOOST® CRANKSHAFT M-6303-23EB

- Production crankshaft as used in the 2015-2018 2.3L EcoBoost® Mustang
- Forged steel construction ready for installation

Also available for an EcoBoost® engine build are:

- M-6010-23EB 2.3L EcoBoost® Cylinder Block
- M-6049-M23 2.3L Mustang EcoBoost® Cylinder Head



Actions speak louder than words.

AGREED.

For more than 35 years Ford Performance Parts has been producing and developing performance parts with enthusiasts in mind. Whether you are building from the ground up or working to get that extra tenth of a second, Ford Performance delivers the products you need. We're proud to offer crate engines and performance components that are designed and engineered to rigorous Ford Performance standards. They have earned their right to wear the Ford Oval.



PERFORMANCEPARTS.FORD.COM

PUSHROD ENGINES AND COMPONENTS



X2347D STREET CRUISER-DRESSED CRATE ENGINE WITH X2 HEADS

M-6007-X2347DF* Front Sump Pan

M-6007-X2347DR* Rear Sump Pan

New X2347 crate engine features the newest cylinder head from Ford Performance, the "X2". The most popular crate engine size just got better and easier thanks to the engineers at Ford Performance.



M-6007-X2347DF shown

The proven 347 stroker combination has been optimized for street cruising with a perfectly matched cam – cylinder head – intake manifold and carburetor combination that runs on pump gas. It takes the guesswork and installation issues out of the way with a complete intake and distributor package that has been developed and tested by Ford Performance Engineers. To dress out the X2347D, The Ford Performance Engineers spec'd parts from some of the best in the aftermarket like Holley®, Edelbrock® and MSD®.

The X2347D is hand assembled with all new parts including Ford Performance "X2" heads and internals from some of the best aftermarket performance parts manufacturers. The BOSS 302 block is bored .030" oversize and fitted with Mahle® forged pistons. The rotating assembly is all SCAT® forged steel – with I beam rods fitted with ARP® rod bolts and full floating pins.

The camshaft is what really makes the X2347D a perfect street cruiser – the intake and exhaust lobes have fast opening ramps to keep port velocity high. The engine idles happily at 800 RPM and pulls 19 inches of vacuum. That translates into snappy acceleration at low engine speeds – and power that pulls strong to 6,000 RPM. New Ford Performance aluminum X2 heads top off the engine. Completing the street tuned package is an Edelbrock Performer RPM® Air-Gap intake and Holley Street Avenger® carburetor. An MSD® Billet Distributor and "Ford Racing" spark plug wires finish the package.

X2347D is a perfect carbureted replacement engine for a vintage muscle car, late model project, truck or street rod. Unlike the imitators, no other crate engine has the Blue Oval heritage and Ford Performance Engineering and Technical support.

360 Horsepower/400 lb.-ft. of Torque

- Engine type: 302 based small block Ford
- Displacement (cu in): 347
- Bore x stroke (in): 4.030" bore x 3.400" stroke
- Block: BOSS 302 8.2" deck - M-6010-BOSS302
- Crankshaft: SCAT® Forged Steel
- Connecting rods: SCAT® forged steel I-beam connecting rods
- Pistons: Forged Mahle® w/ floating wrist pins
- Cylinder Heads: Ford Performance aluminum, 64 cc chamber - M-6049-X2
- Valve size (in): 1.94 intake 1.54 exhaust
- Compression ratio: 9.6:1 Edelbrock Performer RPM® Air Gap Manifold (PN 7521)
- Holley Street Avenger® 570 CFM Carburetor with vacuum secondaries, 4-corner idle and Electric Choke (PN 83570)
- Rocker arms: Roller Rockers 1.6:1 ratio
- Valve covers: "Ford Racing" black satin aluminum M-6582-A301R
- MSD® billet distributor (MSD Part No. 8598)
- "Ford Racing" 9 MM Black Spark Plug Wires - M-12259-M301
- Camshaft type: Hydraulic Roller. Comp Cams® .533" lift intake and exhaust 206° duration intake and exhaust @ .050" lift
- Firing order 1-3-7-2-6-5-4-8 (5.0L HO and 351W order)
- Double roller timing chain set - M-6268-A302
- Vibration Damper: Ford Racing SFI Approved
- Oil pan: high performance front sump 7 quart capacity and windage tray/scrapper
- Recommended fuel: Unleaded premium
- Maximum recommended rpm: 6,000 RPM
- Balanced: Internal. Use neutral balance flywheel

 **WARNING: Cancer** www.P65Warnings.ca.gov

302 CI 340 HP BOSS CRATE ENGINE WITH "E" CAM M-6007-X2302E

New X2302 crate engine features the newest cylinder head from Ford Performance, the "X2", packaged with the legendary E camshaft – for use with auto or manual transmission.



Utilizing all forged internals, the X2302E crate engine is an excellent value and a solid foundation for any performance combination, including forced induction. These crate engines feature race-quality components at competitive pricing.

- 302 cu in
- 340 hp
- 9.0:1 compression ratio (nominal)
- BOSS 4-bolt main block M-6010-BOSS302
- Hydraulic roller camshaft M-6250-E303, .498" lift intake and exhaust, duration at .050" is 220 degrees intake and exhaust
- M-6268-A302 Double Roller Timing Chain Set
- Can be used in kit cars, street rods, Mustang, Fox-bodied cars, and trucks (Rear sump pan fits most Fox-bodied cars)
- Ford Performance aluminum cylinder heads – M-6049-X2
- Does not include intake manifold or distributor (MSD® distributor part no: M8598 recommended)
- Forged pistons
- Forged steel connecting rods
- Forged steel crankshaft
- Roller rocker arms
- Built with all NEW parts

NOTE: Results attained using Edelbrock® Performer AirGap intake and 570 CFM carburetor.

⚠ WARNING: Cancer www.P65Warnings.ca.gov

INSTALLATION NOTES: Some or all of the following items may need to be changed from your original engine or modified for proper installation:

- Depending on your application, a different timing cover, water pump, oil pan and pickup may be required
- Timing cover will work with most standard rotation water pumps
- Engine has a rear sump oil pan and pickup, standard rotation timing cover, reverse rotation water pump and non-EFI valve covers
- Fuel pump eccentric M-6287-B302 installed, allows use of mechanical fuel pump
- Valve covers M-6582-W351PR should fit most non-EFI applications. Optional valve covers sold separately
- The damper M-6316-D302 may require a spacer for pulley alignment
- Flywheel included – M-6375-D302B, will work for most 157-tooth manual transmission applications. For other transmissions use the proper neutral balance flywheel
- Intake manifold not included
- Includes intake gaskets M-9439-A50 as well as pilot bearing
- Firing order 1-3-7-2-6-5-4-8 (5.0L HO and 351W firing order)
- Steel distributor gear required
- Shipping weight approximately 525 lbs

Photo and specs may vary.

PUSHROD ENGINES / COMPONENTS (CONTINUED)

347CI 350HP CRATE ENGINE-SEALED RACING "X2" CYLINDER HEAD M-6007-S347JR2



Ford Sealed Racing Engines are built to professional racing series standards and deliver reliable lasting performance.

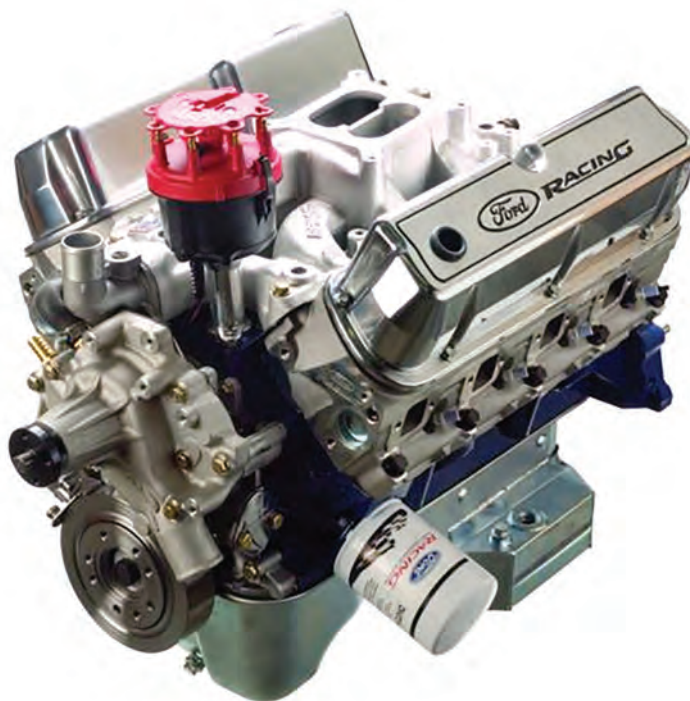

These aren't built from repackaged production parts, but real racing parts like Forged Crank, Rods and Pistons with full floating piston pins. Based on the Ford Performance BOSS 302 block these engines deliver reliable and consistent performance lap after lap. S347JR has been approved for use in the American Canadian Tour (ACT) Late Model series.

Built for asphalt and circle track racing series that require a sealed or "crate" racing engine.

- 347 cubic inches - 4.030" bore - 3.400" stroke
- Ford Performance BOSS 302 race block M-6010-BOSS302
- 350 hp @ 5500 rpm - 400 lb-ft of torque @ 4000 rpm with headers, and 2V 500 CFM Holley carburetor (not included)
- 10.5:1 Compression ratio (nominal)
- SCAT® forged crankshaft
- SCAT® forged steel cap screw connecting rods
- Forged Mahle® pistons with floating pin
- Comp Cams 35-410-8 Hydraulic roller camshaft .533" lift intake and exhaust, duration at .050" is 206 degrees intake and exhaust
- Double roller timing chain set M-6268-A302
- High-performance 7 quart rear sump circle track oil pan
- MSD® billet distributor
- ARP® Head Studs
- Ford Performance aluminum "X2" cylinder heads M-6049-X2 with 1.94" intake valves and 1.54" exhaust valves
- PAC® 1219X ovate beehive valve springs
- 1.60:1 ratio roller rocker arms M-6564-B351
- Edelbrock® Performer RPM Air-Gap dual plane aluminum intake manifold
- Edelbrock® water pump

- MSD® billet distributor
- High volume oil pump M-6600-D2
- Ford Performance polished aluminum valve covers M-6582-CT2
- High-performance SFI Approved vibration damper M-6316-D302
- Engine weight as equipped is 414 lbs. (includes 7 quarts of oil)
- Engine is sealed for circle track competition where rules allow
- Competes against GMPP "603" crate engine
- Engine is internally balanced, "0" balance flywheel required
- Flywheel not included

INSTALLATION NOTES: See engine installation and tuning tips below. Some or all of the following items may need to be changed from your original engine or modified for proper installation:

This engine has a rear sump performance oil pan and pickup, regular rotation timing cover and regular rotation water pump, and non-EFI valve covers.

- The timing chain cover will work with most regular rotation water pumps
- Fuel pump eccentric M-6287-B302 installed, allows use of mechanical fuel pump
- A standard rotation water pump is installed on the engine. Other applications may require different water pumps and timing chain covers
- The damper M-6316-D302 may require a spacer for pulley alignment
- Ford Performance flywheel M-6375-D302B is not included but will work for most 157-tooth manual transmission applications. For other transmission applications use the proper "0" balance flywheel
- Firing order 1-3-7-2-6-5-4-8 (5.0L HO and 351W order)
- Built with current available parts. Photo and specs may vary
- Shipping weight approximately 475 lbs

⚠ WARNING: Cancer www.P65Warnings.ca.gov

347 CUBIC INCH 415 HP SEALED RACING ENGINE

M-6007-D347SR

M-6007-D347SR7 7 MM Valves



Ford Sealed Racing Engines are built to professional racing series standards and deliver reliable lasting performance. These aren't built from repackaged production parts, but real racing parts like Forged Crank, Rods and Pistons with full floating piston pins. Each engine is assembled by hand with racing clearances. Built with the Ford Performance BOSS 302 block these engines deliver reliable and consistent performance lap after lap.



- Built for asphalt and dirt circle track racing series that require a sealed racing engine
- 347 cubic inches - 4.030" bore - 3.400" stroke
- BOSS 302 race block
- 415 hp @ 6000 rpm 400 lb-ft @ 4900 rpm (with headers, and a 650 CFM Holley carburetor not included)
- 10:1 Compression ratio (nominal)
- SCAT® forged crankshaft
- SCAT® forged steel cap screw connecting rods
- Mahle® forged pistons with floating pins
- Hydraulic roller camshaft M-6250-F303, .528" lift intake and exhaust, duration at .050" is 226 degrees intake and exhaust
- Double roller timing chain set M-6268-A302
- High-performance 7 quart rear sump circle track oil pan
- Ford Performance aluminum "Z" cylinder heads M-6049-Z304DA with 2.02" intake valves and 1.60" exhaust valves
- PAC® 1219X ovate beehive valve springs
- 1.65:1 ratio roller rocker arms
- Edelbrock® Victor Jr. intake manifold M-9424-D302
- Edelbrock® Water Pump
- SFI approved vibration damper
- MSD® billet distributor
- ARP® Head Studs
- Ford Racing polished aluminum Circle Track valve covers M-6582-CT2
- Ford Performance M-6600-D2 High volume oil pump
- Engine is sealed for circle track competition where rules allow

- Engine weight as equipped is 431 lbs. (includes 7 quarts of oil)
- Competes directly with the GMPP® "604" crate engine
- Engine is internally balanced, "0" balance flywheel required
- Flywheel is not included

INSTALLATION NOTES: See engine installation and tuning tips. Some or all of the following items may need to be changed from your original engine or modified for proper installation:

- This engine has a rear sump performance oil pan and pickup, regular rotation timing cover and regular rotation water pump, and non-EFI valve covers. Depending on your application, a different timing cover, water pump, performance oil pan and pickup may be required. See installation notes
- Fuel pump eccentric M-6287-B302 installed, allows use of mechanical fuel pump
- A standard rotation water pump is installed on the engine. Other applications may require different water pumps and timing chain covers
- Damper M-6316-D302, may require a spacer for pulley alignment
- Ford Performance flywheel M-6375-D302B not included but will work for most 157-tooth manual transmission applications
- Firing order 1-3-7-2-6-5-4-8 (5.0L HO and 351W order)
- Built with current available parts
- Photo and specs may vary
- Shipping weight approximately 475 lbs
- Race Application-no warranty

⚠ WARNING: Cancer www.P65Warnings.ca.gov

PUSHROD ENGINES / COMPONENTS (CONTINUED)



363 CUBIC INCH 500 HP BOSS CRATE ENGINE – “Z2” HEADS

- M-6007-Z2363FT* Front Sump Pan
- M-6007-Z2363RT* Rear Sump Pan



M-6007-Z2363FT shown

New Z2 cylinder heads with “Velocity Vane.”

- 507 hp on pump gas – in a 302-sized package
- Built with our best new parts
- Uses standard SBF headers and accessory mounts
- From the guys who know Ford Performance Best – Ford Performance engineers

507 hp @ 6500 rpm* 450 lb-ft torque @ 5100 rpm*

- Engine type: 302-based small block Ford
- Displacement: 363 cu in
- Bore x stroke: 4.125" bore x 3.400" stroke
- Block: BOSS 302 8.2 deck M-6010-BOSS302
- Crankshaft: SCAT® forged steel
- Connecting rods: SCAT® forged steel I-beam connecting rods and ARP® bolts
- Pistons: Forged Mahle® w/floating wrist pins
- Camshaft type: Hydraulic roller
- Camshaft lift: .580"/.602"
- Camshaft duration (@.050 in): 232°/240°
- Cylinder heads: Ford Performance M-6049-Z2 Aluminum “Z2” Cylinder Heads
- Valve size: 2.05" intake, 1.60" exhaust
- Valve springs: PAC® 1219X Ovate Beehive™
- Compression ratio: 10.2:1 (nominal)
- Rocker arms: Roller rockers – 1.65:1 ratio
- Vibration damper: Ford Performance SFI approved
- Valve covers: “Ford Racing” cast aluminum 302-139
- Oil pan: high performance, 7 qt capacity and windage tray/scrapper
- Water pump: Edelbrock® high performance
- Includes Ford Performance M-9439-A50 intake manifold gaskets
- Does not include distributor, intake and flywheel
- Required fuel: Premium unleaded
- Built with current available parts. Photo and specs may vary
- Engine installation tuning tips at performanceparts.ford.com

***NOTE:** Results obtained using Edelbrock® Super Victor intake manifold and 750 CFM carburetor. This combination does not fit all applications.

⚠ WARNING: Cancer www.P65Warnings.ca.gov

427 CUBIC INCH 535 HP CRATE ENGINE – “Z2” HEADS

M-6007-Z2427FFT* Front Sump Pan
M-6007-Z2427FRT* Rear Sump Pan



The company that created the famous 427 FE engine offers a modern version of the legendary motor. Built on the Ford Performance BOSS 351 block, the 427 crate engine is engineered and built for driveability and durability while delivering big power. Ideal for Ford projects requiring 500+ horsepower in a reliable small block package. Now equipped with Ford Performance “Z2” cylinder heads – these heads promote excellent power throughout the rpm range while retaining OEM exhaust and accessory mounting locations when compared to other aftermarket cylinder heads.



M-6007-Z2427FFT shown

535 hp @ 5600 rpm*

545 lb-ft torque @ 4500 rpm*

- Engine type: 351-based small block Ford
- Displacement: 427 cu in
- Bore x stroke: 4.125" bore x 4.00" stroke
- Block: BOSS 351 9.5 deck
- Crankshaft: SCAT® forged steel
- Connecting rods: SCAT® forged steel H-beam connecting rods and ARP® bolts
- Pistons: Forged Mahle® w/floating wrist pin
- Camshaft type: Hydraulic roller
- Camshaft lift: .594"/.618"
- Camshaft duration – intake/exhaust (@.050"): 242°/248°
- Cylinder heads: Ford Performance M-6049-Z2 Aluminum “Z2” Cylinder Heads
- Valve size: 2.05" intake, 1.60" exhaust
- Valve springs: PAC® 1219X Ovate Beehive™
- Compression ratio: 10.5:1 (nominal)
- Rocker arms: Roller rockers
- Rocker arm ratio: 1.65:1
- M-6316-D302 Vibration Damper – Ford Performance SFI approved
- Valve covers: Satin black, aluminum with “Ford Racing” script – 302-135
- Oil pan: Steel with deep sump pan with windage tray/scrapper
- Water pump: included long type – standard rotation
- Distributor: not included. MSD® distributor – Part No. 85840 recommended (distributor modifications for intake clearance necessary)
- Recommended fuel: Premium unleaded
- Ignition timing: 32° at 4000 rpm

- Maximum recommended rpm: 5600 rpm
- Balanced: Internally balanced – use neutral balance flywheel (not included)
- Recommended intake: Edelbrock® Part No. 2924 Super Victor® (not included)
- Front sump pan fits most kits cars without Mustang II suspension
- New block, oil and water pumps, performance oil pan and high-performance harmonic balancer
- Can be used in kit cars, street rods, Mustang, cars and trucks
- Water pump included – standard rotation
- Depending on your application, a different timing cover, water pump, performance oil pan and pickup may be required
- Engine has a performance deep sump oil pan and pickup, standard rotation timing cover, standard rotation water pump and non-EFI valve covers
- Timing cover will work with most standard rotation water pumps
- M-6287-B302 Fuel Pump Eccentric installed, allows use of mechanical fuel pump
- Valve covers should fit most non-EFI applications. Optional valve covers sold separately
- M-6316-D302 Damper may require a spacer for pulley alignment
- Intake manifold not included
- Includes intake gaskets and pilot bearing
- Firing order 1-3-7-2-6-5-4-8 (5.0L HO and 351W firing order)
- Steel distributor gear required
- Shipping weight approximately 570 lbs
- Built with current available parts. Photo and specs may vary
- Engine installation tuning tips at performanceparts.ford.com

***NOTE:** Results attained using Edelbrock® Super Victor intake manifold and 770 CFM carburetor.

PUSHROD ENGINES / COMPONENTS (CONTINUED)



460 CUBIC INCH 575 HP BOSS CRATE ENGINE

M-6007-Z460FFT* Front Sump Pan

M-6007-Z460FRT* Rear Sump Pan

Ford Performance has taken its BOSS block to the max with the biggest small block Windsor crate engine ever – the Z460. With 575 horsepower and 575 lb-ft of torque, Z460 packs a pump-gas-fueled punch that works well on the street and on the track.

The foundation of Z460 is the legendary Ford Performance BOSS block topped off with high-port/high-flow “Z” heads. Premium components from the best aftermarket companies are used throughout the engine, like a SCAT® forged steel crankshaft, SCAT® forged H-beam connecting rods, forged Mahle® pistons and Clevite® bearings. Every Ford Performance Z460 engine is hand assembled in the U.S. with performance clearances.



M-6007-Z460FRT

575 hp @ 5500 rpm

575 lb-ft torque @ 4700 rpm

- Engine type: 351-based small block Ford
- Displacement: 460 cu in
- Bore x stroke: 4.150" bore x 4.250" stroke
- Block: BOSS 351 9.5" deck
- Crankshaft: SCAT® forged steel
- Connecting rods: SCAT® forged steel H-beam 6.125" length connecting rods
- Pistons: Forged Mahle® w/floating wrist pin
- Camshaft type: Hydraulic roller
- Camshaft lift: .594"/.618"
- Camshaft duration (@.050 in): 242°/248°
- Cylinder heads: Ford Performance M-6049-Z304DA Aluminum “Z” Cylinder Heads
- Valve size: 2.02" intake, 1.60" exhaust
- Compression ratio: 10.0:1 (nominal)
- Rocker arm ratio: 1.65:1
- M-6316-D302 Vibration Damper: Ford Performance – SFI approved
- Valve covers: Ford Performance 302-137 cast aluminum gray crinkle, “Ford Racing” logo
- Oil pan: Steel with deep front (9 qt) or rear sump (7 qt) pan with louvered windage tray and crankshaft scraper – 9 qt capacity
- Ford Performance M-8501-G351 Water Pump: included, long-type – standard rotation
- Includes Ford Performance M-9439-A50 Intake Manifold Gaskets
- Distributor: not included. Steel distributor gear required
- Required fuel: Premium unleaded
- Ignition timing: 32° at 4000 rpm

- Maximum recommended rpm: 5600 rpm
- Balanced: Internal. Use neutral balance flywheel
- Recommended intake: Edelbrock® Part No. 2924 Super Victor® (not included)
- New block, oil pump, water pump, performance oil pan and high-performance harmonic balancer
- Engine power ratings achieved with Edelbrock® Super Victor® intake, Holley® 850 CFM carburetor, long tube headers

INSTALLATION NOTES: Some or all of the following items may need to be changed from your original engine or modified for proper installation:

- Depending on your application, a different timing cover, water pump, performance oil pan and pickup may be required
- Engine has a performance sump oil pan and pickup, standard rotation timing cover, standard rotation water pump and non-EFI valve covers
- Timing cover will work with most standard rotation water pumps
- M-6287-B302 Fuel Pump Eccentric installed, allows use of mechanical fuel pump
- Valve covers should fit most non-EFI applications. Optional valve covers sold separately
- M-6316-D302 Damper may require a spacer for pulley alignment
- Flywheel not included, use proper neutral balance flywheel
- Intake manifold not included
- Includes intake gaskets and pilot bearing
- Firing order 1-3-7-2-6-5-4-8 (5.0L HO and 351W firing order)
- Steel distributor gear required
- Exhaust port raised 5/8" may require custom headers
- Shipping weight approximately 570 lbs
- Built with current available parts. Photo and specs may vary
- Engine installation tuning tips at performanceparts.ford.com

347 CUBIC INCH BOSS SHORT BLOCK M-6009-347



The Ford Performance 347 short block lets you build it your way by adding your choice of heads, cam, intake and oil pan. It's a perfect foundation to build a powerful 8.2" deck engine for your vintage muscle car, street rod, Fox body or late model Mustang. This is the same short block used in the 347 sealed racing crate engines, M-6007-D347SR and M-6007-S347JR. Nothing but our best parts are used inside, including: forged crankshaft, forged I-beam connecting rods with floating piston pins and the BOSS 302 block.

- Engine type: 302 based small block Ford
- Displacement: 347 cu in
- Bore x stroke: 4.030" bore x 3.400" stroke
- Block: M-6010-BOSS302 BOSS 4-Bolt Main Block 8.2" deck height
- Piston-to-deck height: .010" below deck (nominal)
- Crankshaft: SCAT® forged steel: 3.400" stroke
- Connecting rods: SCAT® forged steel I-beam connecting rods with floating pin and ARP® bolts
- Pistons: Mahle® forged aluminum, 1.5 mm, 1.5 mm, 3.00 mm rings, valve reliefs for X306, X307, Z304DA, Z304P, N351, and other inline valve Windsor cylinder heads. 6 cc valve pockets. Check piston-to-valve clearance
- Hydraulic roller camshaft compatible
- Internally balanced. Requires "O" balance flywheel and damper
- Recommended cylinder head fasteners M-6065-BOSS Head Bolts or M-6014-BOSS Studs depending on application
- Most aftermarket performance cylinder heads are compatible with this short block. Ford Performance short blocks are built with pistons designed for 20 degree valve angle heads and will fit stock or most spread valve guide center lines
- Works well with Ford Performance cylinder heads M-6049-Z2 and M-6049-X2
- Designed for M-6049-X306/X307/Z304DA/Z304P and N351 cylinder heads. Not designed for production 302/351W or M-6049-Y302/Y303/X302/X303/X304/X305 cylinder heads

- Assembled and ready for your heads, cam and timing chain set
- Requires M-6051-CP331 or M-6051-S331 head gaskets
- High-performance M-6316-D302 Harmonic Balancer is recommended
- High-volume M-6600-D2 Oil Pump recommended
- 302 bolt pattern, oil pan and timing cover
- Built with all NEW PARTS
- Photo and specs may vary



WARNING: Cancer www.P65Warnings.ca.gov

363 CUBIC INCH BOSS SHORT BLOCK M-6009-363



The Ford Performance Z363 short block lets you build it your way by adding your choice of heads, cam, intake and oil pan. It's a perfect foundation to build a powerful 8.2" deck engine for your vintage muscle car, street rod, Fox body or late model Mustang. This is the same short block used in the 500 hp M-6007-Z2363FT Crate Engine. By taking the bore out to 4.125", the displacement of the popular 347 stroker has been increased to 363 cubic inches. Nothing but our best parts are used inside, including: forged crankshaft, forged I-beam connecting rods with floating piston pins and the BOSS 302 block. The Z363 short block fits many of the vehicles originally built with a 289 or 302 8.2" deck height block.

- Engine type: 302 based small block Ford
- Displacement: 363 cu in
- Bore x stroke: 4.125" bore x 3.400" stroke
- Block: BOSS M-6010-BOSS302 4-Bolt Main Block 8.2" deck height
- Piston-to-deck height: .010" below deck (nominal)
- Crankshaft: SCAT® forged steel: 3.400" stroke
- Connecting rods: SCAT® forged steel I-beam connecting rods with floating pin and ARP® bolts
- Pistons: Mahle® forged aluminum, 1.5 mm, 1.5 mm, 3.00 mm rings, valve reliefs for X306, X307, Z304DA, Z304P, N351, and other inline valve Windsor cylinder heads. 6 cc valve pockets. Check piston-to-valve clearance
- Hydraulic roller camshaft compatible
- Internally balanced. Requires "O" balance flywheel and damper
- Recommended cylinder head fasteners M-6065-BOSS Head Bolts or M-6014-BOSS Studs depending on application
- Most aftermarket performance cylinder heads are compatible with this short block. Ford Performance short blocks are built with pistons designed for 20° valve angle heads and will fit stock or most spread valve guide center lines
- Works well with Ford Performance cylinder heads M-6049-Z2 and M-6049-X2
- Designed for M-6049-X306/X307/Z304DA/Z304P and N351 cylinder heads. Not designed for production 302/351W or M-6049-Y302/Y303/X302/X303/X304/X305 cylinder heads

- Assembled and ready for your heads, cam and timing chain set
- Requires M-6051-R351 Head Gaskets
- High-performance M-6316-D302 Harmonic Balancer is recommended
- High-volume M-6600-D2 Oil Pump recommended
- 302 bolt pattern, oil pan and timing cover
- Built with all NEW PARTS
- Photo and specs may vary



WARNING: Cancer www.P65Warnings.ca.gov

PUSHROD ENGINES / COMPONENTS (CONTINUED)

427 ALUMINUM SHORT BLOCK

M-6009-427A

Build it your way with Ford Performance short blocks. Want to build a powerful Ford engine for your vintage muscle car, street rod, Fox body or late model Mustang? A Ford Performance short block is the perfect foundation. Ford Performance engineers have taken care of the toughest part of building a new engine by designing a strong, durable short block that offers a wide range of power possibilities. We use only our best parts for our short blocks, like a forged steel crankshaft, forged H-beam connecting rods with floating piston pins, forged Mahle® pistons, and the Ford Performance aluminum block. And every Ford Performance short block is hand assembled in the U.S. with performance clearances; these aren't assembly line truck engines made by machines!

- Engine type: 351 based small block Ford
- Displacement: 427 cu in
- Bore x stroke: 4.125" bore x 4.00" stroke
- Block: Ford Performance M-6010-Z351 Aluminum 4-Bolt Main Block 9.5" deck height
- Piston-to-deck height: .005" below piston-to-deck height (nominal)
- Crankshaft: SCAT® forged steel: 4.000" stroke
- Connecting rods: SCAT® forged steel H-beam connecting rods with floating pin and ARP® bolts
- Pistons: Mahle® 4.125" bore forged, with reliefs for Z304D, Z304P, N351, and other inline valve Windsor cylinder heads. 17 cc piston dish. Check piston-to-valve clearance
- Hydraulic roller camshaft compatible. Requires aftermarket tie bar hydraulic lifters
- 0.060" oil galley restrictors included for solid roller cam applications
- Internally balanced
- Uses standard Windsor M-6059-D351 Timing Cover
- Standard Windsor oil pan flange
- Recommended cylinder head fasteners M-6065-BOSS Head Bolts or M-6014-BOSS Studs depending on application
- Most aftermarket performance cylinder heads are compatible with this short block. Ford Performance short blocks are built with pistons designed for 20° valve angle heads and will fit stock or spread valve guide center lines
- Works well with Ford Performance cylinder heads M-6049-Z2 and M-6049-X2
- Not designed for production 302/351W or M-6049-Y302/Y303/X302/X303/X304/X305 cylinder heads
- Assembled and ready for your heads, cam and timing chain set
- Requires M-6051-R351 Head Gaskets
- Oil pan and timing cover are a 351W bolt pattern
- High-performance M-6316-D302 Harmonic Balancer is recommended
- Built with all NEW PARTS
- Photo and specs may vary



WARNING: Cancer www.P65Warnings.ca.gov

427 CUBIC INCH BOSS SHORT BLOCK

M-6009-427F

The Ford Performance 427 short block lets you build it your way by adding your choice of heads, cam, intake and oil pan. It's a perfect foundation to build a powerful 9.5" deck engine for your vintage muscle car, street rod, Fox body or late model Mustang. This is the same short block used in the 575 hp Z427 crate engine. Nothing but our best parts are used inside, including: forged crankshaft, forged I-beam connecting rods with floating piston pins and the BOSS 351 block. This short block is hand assembled with performance clearances in the U.S. The 427 short block fits many of the vehicles originally built with Windsor and Cleveland small blocks.

- Engine type: 351 based small block Ford
- Displacement: 427 cu in
- Bore x stroke: 4.125" bore x 4.00" stroke
- Block: BOSS M-6010-BOSS35195 4-Bolt Main Block 9.5" deck height
- Piston-to-deck height: .005" below piston-to-deck height (nominal)
- Crankshaft: SCAT® forged steel: 4.000" stroke
- Connecting rods: SCAT® forged steel H-beam connecting rods with floating pin and ARP® bolts
- Pistons: Mahle® forged aluminum, with reliefs for Z304D, Z304P, N351, and other inline valve Windsor cylinder heads. 17 cc piston dish. Check piston-to-valve clearance
- Hydraulic roller camshaft compatible
- Internally balanced
- Recommended cylinder head fasteners M-6065-BOSS Head Bolts or M-6014-BOSS Studs depending on application
- Most aftermarket performance cylinder heads are compatible with this short block. Ford Performance short blocks are built with pistons designed for 20° valve angle heads and will fit stock or spread valve guide center lines
- Works well with Ford Performance cylinder heads M-6049-Z2 and M-6049-X2
- Designed for M-6049-X306/X307/Z304DA cylinder heads. Not designed for production 302/351W or M-6049-Y302/Y303/X302/X303/X304/X305 cylinder heads
- Assembled and ready for your heads, cam and timing chain set
- Requires M-6051-R351 Head Gaskets
- 351W bolt pattern, oil pan and timing cover
- High-performance M-6316-D302 Harmonic Balancer is recommended
- Built with all NEW PARTS
- Photo and specs may vary



WARNING: Cancer www.P65Warnings.ca.gov



460 CUBIC INCH BOSS SHORT BLOCK – WINDSOR SB BASED

M-6009-460

Build it your way with Ford Performance short blocks. Want to build a powerful Ford engine for your vintage muscle car, street rod, Fox body or late model Mustang? A Ford Performance short block is the perfect foundation. Ford Performance engineers have taken care of the toughest part of building a new engine by designing a strong, durable short block that offers a wide range of power possibilities. We use only our best parts for our short blocks, like a forged steel crankshaft, forged H-beam connecting rods with floating piston pins, forged Mahle® pistons, and the Ford Performance BOSS block. And every Ford Performance short block is hand assembled in the U.S. with performance clearances – these aren't assembly line truck engines made by machines!

- Engine type: 351 based small block Ford
- Displacement: 460 cu in
- Bore x stroke: 4.150" bore x 4.25" stroke
- Block: BOSS M-6010-BOSS35195 4-Bolt Main Block 9.5" deck height
- Piston-to-deck height: .005" below piston-to-deck height (nominal)
- Crankshaft: SCAT® forged steel: 4.250" stroke
- Connecting rods: SCAT® forged steel H-beam 6.125" length connecting rods with floating pin and ARP® bolts
- Pistons: Mahle® 4.150" bore forged, with reliefs for Z304D, Z304P, N351, and other inline valve Windsor cylinder heads. 30 cc piston dish. Check piston-to-valve clearance
- Hydraulic roller camshaft compatible
- Internally balanced
- Recommended cylinder head fasteners M-6065-BOSS Head Bolts or M-6014-BOSS Studs depending on application
- Most aftermarket performance cylinder heads are compatible with this short block. Ford Performance short blocks are built with pistons designed for 20° valve angle heads and will fit stock or spread valve guide center lines
- Works well with Ford Performance cylinder heads M-6049-Z2 and M-6049-X2
- Designed for M-6049-X306/X307/Z304DA cylinder heads. Not designed for production 302/351W or M-6049-Y302/Y303/X302/X303/X304/X305 cylinder heads
- Assembled and ready for your heads, cam and timing chain set
- Requires M-6051-R351 Head Gaskets
- 351W bolt pattern, oil pan and timing cover
- High-performance M-6316-D302 Harmonic Balancer is recommended
- Built with all NEW PARTS
- Photo and specs may vary



⚠ WARNING: Cancer www.P65Warnings.ca.gov

351 ALUMINUM BLOCK 9.5-INCH DECK

M-6010-Z351

- High-strength aluminum block, 356-T6 grade aluminum
- Splayed 4-bolt, steel billet main caps on 2, 3 and 4
- 2-bolt main caps on 1 and 5
- 4.110"-4.115" bore as delivered, cast iron sleeves – finish at 4.125"
- 9.5" deck height, accepts small block timing chain, timing chain cover and oil pump
- 2.75" crankshaft (351C) main journal diameter. 2.9415"-2.9425" diameter finished main bearing bore
- Lifter bores finished .8753"-.8768"
- 2.2032"-2.2052" diameter cam bearing bores. Uses M-6261-J351 or M-6261-R351 cam bearings
- Maximum stroke 4.250"
- Wet sump oiling system
- Weight 118 lbs

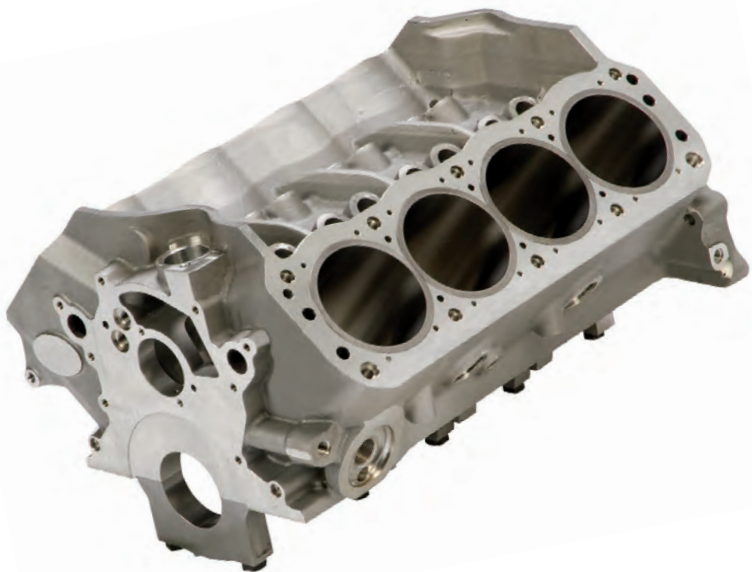

PUSHROD ENGINES / COMPONENTS (CONTINUED)
351 ALUMINUM BLOCK 9.2-INCH DECK
M-6010-Z35192

Ford Performance has added a 9.2" deck height version of its Z351 aluminum Windsor block to its product line. This 9.2" deck height block is great for smaller displacement builds without the penalty of a taller deck. Like the 9.5" deck height version, the block is cast from high-strength 356-T6 grade aluminum and uses splayed 4-bolt main caps on #2-3-4 mains. The block is "user friendly" and designed to use conventional Windsor components, like cam, timing chain, timing chain cover, oil pan and oil pump. With a weight of 106 pounds, it's nearly 90 pounds lighter than an iron Ford Performance Race Parts BOSS 351 block.

- High-strength aluminum block, 356-T6 grade aluminum
- Splayed 4-bolt, steel billet main caps on 2, 3 and 4
- 2-bolt main caps on 1 and 5
- ARP® studs on all inner mains; ARP® bolts on 2-3-4 splayed outer positions
- Uses standard Windsor timing chain, timing chain cover, oil pan and oil pump
- 4.110"-4.115" bore as delivered, cast iron sleeves – finish at 4.125"
- 9.2" deck height, 2.75" crankshaft (351C) main journal diameter
- 2.9415"-2.9425" diameter finished main bearing bore
- Lifter bores finished .8753"-.8768"
- 2.2032"-2.2052" diameter cam bearing bores. Uses M-6261-J351 or M-6261-R351 cam bearing
- Maximum stroke 4.000"
- Wet sump oiling system
- Weight 106 lbs

CYLINDER SLEEVE SET FOR M-6010-Z351 BLOCK
M-6012-C351

- Replacement sleeves for the M-6010-Z351 Block
- Standard 4.280" O.D. and 4.075" I.D.
- Sold in set of 8

CYLINDER SLEEVE SET FOR M-6010-Z35192 BLOCK
M-6012-C35192

- Replacement sleeves for the M-6010-Z35192 Block
- Standard 4.280" O.D. and 4.075" I.D.
- Sold in set of 8



BOSS BLOCKS

- 302 to 468 Cubic Inches
- 8.2" – 9.2" – 9.5" Deck
- CNC-machined for exacting tolerances of +/- 0.001"
- The foundation for building power and race-winning performance



"Using a BOSS 351 block as a foundation became a no-brainer. The block provides impressive bang for the buck and hardly costs any more than a stock Windsor block that has been fully machined and blueprinted. But the BOSS block still has some advantages over that, namely, it's cast using diesel-grade iron, which exhibits a much greater tensile strength than a stock casting. Plus, there is extra meat in all the critical stress areas."

"When you put it all together, you get a block that shrugs off 500-plus horsepower blasts and asks for more."

– Jeff Huneycutt / Project Big-Inch BOSS, 5.0 Magazine

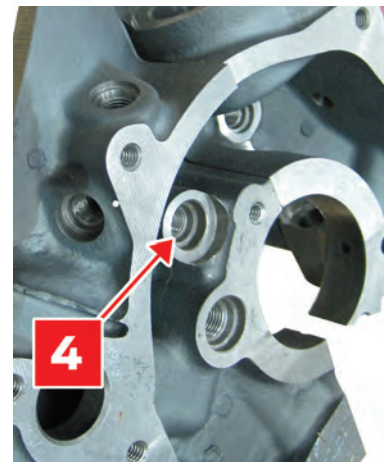
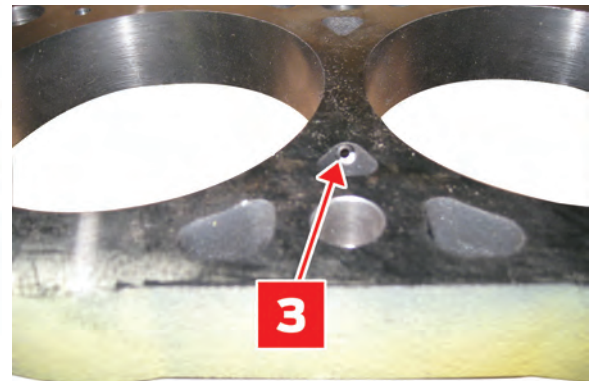
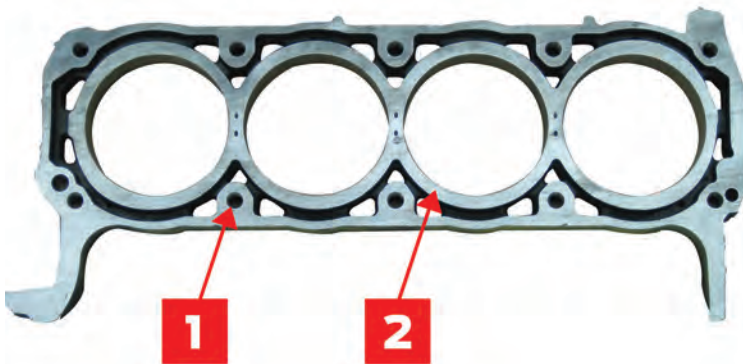

- 1** 1/2" head bolt columns moved lower in the block to minimize bore distortion and improve clamping force
- 2** Siamese bore with thick cylinder walls and exterior walls
- 3** Drilled coolant crossover holes to aid cooling
- 4** NASCAR®-inspired front feed to both lifter oil galleys

PUSHROD ENGINES / COMPONENTS (CONTINUED)



FORD PERFORMANCE BOSS CYLINDER BLOCKS

Ford Performance engineers have designed the replacement for the legendary BOSS 302 and 351 blocks using the latest technology and manufacturing techniques from both the production and racing worlds. The BOSS block capability has been proven around the world – both on the track and on the street. By preserving many of the dimensions and features from the original 289-351 blocks, the BOSS blocks are compatible as replacements for use in just about any vehicle that used a Windsor-style engine. Cast from diesel-grade iron and designed with added material in key areas, BOSS block strength is superior to any Ford OE block ever produced.

- Nodular iron main caps – splayed 4-bolt pattern on 2, 3, 4 mains. 2-bolt main on first and fifth main caps
- Finished lifter bores – uses stock size 302/351 lifters
- Machined to accept factory hydraulic roller lifter guides and lifter guide retainer
- NASCAR®-inspired revised oiling and cooling system
- Siamese bore with drilled coolant crossover holes to aid cooling – except on big bore versions
- Increased bulkhead material and deck thickness (.500"-.560")
- Threaded core and galley plugs (straight thread port plugs with O-ring)
- Head bolt thread engagement is moved lower in the block to minimize bore distortion and thus requires special length 1/2" head bolts
- Designed for Ford Performance M-6049-X2/306/X307/C3/D3/Z2/Z304DA or Yates®-style cylinder heads. Not designed for production 302/351W or M-6049-Y302/Y303/X302/X303/X304/X305 cylinder heads
- Uses common O.D. cam bearings
- Unique M-6026-S351 Cam Plug included
- Retains clutch cross shaft pivot hole
- Original-style oil filter location – M-6731-FL1A recommended
- Original motor mount BOSS locations
- Original bellhousing pattern

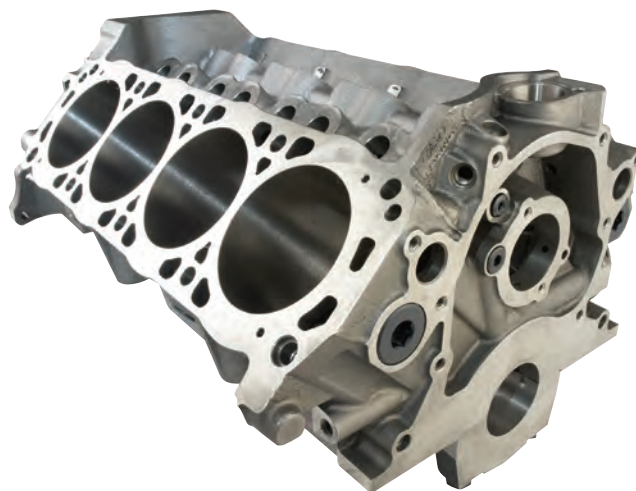

Designed to be compatible with the original 302 and 351W blocks and includes the following features:

- Designed to use stock-type timing cover. M-6059-D351 Timing Cover recommended (includes fuel pump provision)
- Fits factory Mustang oil pan with M-6622-BOSS302 Custom Oil Pickup Tube

BLOCK	BOSS 302 BIG BORE	BOSS 351 9.2 DECK BIG BORE	BOSS 302	BOSS 351 9.2 DECK	BOSS 351 9.5" DECK	BOSS 351 9.5 DECK BIG BORE
PART NUMBER	M-6010-B302BB	M-6010-B35192BB	M-6010-BOSS302	M-6010-BOSS35192	M-6010-BOSS35195	M-6010-BOSS351BB
Bore Size as Delivered	3.990"-3.995"	4.115"-4.120"	3.990"-3.995"	4.115"-4.120"	3.990"-3.995"	4.115"-4.120"
Siamese Bore	Yes	Yes	Yes	Yes	Yes	Yes
Cross Drilled	Yes	No	Yes	No	Yes	No
Maximum Bore Size	4.125"	Sonic test for greater than 4.125"	4.125"	Sonic test for greater than 4.125"		Sonic test for greater than 4.125"
Maximum Stroke Recommended	3.400"	3.400"	4.000"	4.000"	4.250"	4.250"
Main Bearings	Main bearing bore same as stock 302	Main bearing bore same as stock 302	Main bearing bore same as stock 351 Cleveland	Main bearing bore same as stock 351 Cleveland	Main bearing bore same as stock 351 Cleveland	Main bearing bore same as stock 351 Cleveland
Deck Thickness	.500"-.560"	.500"-.560"	.500"-.560"	.500"-.560"	.500"-.560"	.500"-.560"
Head Bolt Size	1/2-13 UNC					
Lifter Bore Size	.8753"-.8768"	.8753"-.8768"	.8753"-.8768"	.8753"-.8768"	.8753"-.8768"	.8753"-.8768"
Rear Seal Type	M-6701-B302 1-Piece Rear Seal	M-6701-B302 1-Piece Rear Seal	M-6701-B351 1-Piece Rear Seal	M-6701-B351 1-Piece Rear Seal	M-6701-B351 1-Piece Rear Seal	M-6701-B351 1-Piece Rear Seal
Weight	175	175	195	195	205	205
Maximum Displacement	363 cubic inches	363 cubic inches	427 cubic inches	427 cubic inches	454 cubic inches	468 cubic inches

RECOMMENDED PARTS						
Head Gaskets	M-6051-S331 M-6051-CP331 M-6051-R351 M-6051-B341	M-6051-R351	M-6051-S331 M-6051-CP331 M-6051-R351 M-6051-B341	M-6051-R351	M-6051-S331 M-6051-CP331 M-6051-R351 M-6051-B341	M-6051-R351
Cam Bearings	M-6261-J351					
Head Stud Kit	M-6014-Z304, M-6014-BOSS Head Stud Kit					
Head Bolt Kit	M-6014-BOSS Head Bolt Kit					
Rear Main Seal	M-6701-B302	M-6701-B302	M-6701-B351	M-6701-B351	M-6701-B351	M-6701-B351

NEW S347/D347SR/D347SR7
CONNECTING ROD SET W/7/16" ROD BOLTS
 M-6200-716



- SCAT connecting rods for 347 and 363 Ford Performance Crate Engines
- Uses 7/16" ARP rod bolts



PLUG AND DOWEL KIT
 M-6026-A



Service replacement plug and dowel kit for M-6010-BOSS302/BOSS35192/BOSS35195/BOSS351BB and 351 race blocks with O-ring threaded plugs. Black anodized aluminum plugs with Buna® O-rings for the oil galleys, water drains and core holes. Dowels for front cover, clutch housing and cylinder heads.



ENGINE BLOCK THREADED CORE PLUGS
 M-6026-B302



- Fits 289/302/351C/351W/429/460
- Includes 6 threaded 1.25" NPT cast iron plugs
- Block tapped 1.25" NPT to accept plugs
- Ford Performance M-6010-A460 Block



FORD PERFORMANCE ENGINE BLOCK – CAMSHAFT PLUG KIT
 M-6026-S351



- Service camshaft plugs for Ford Performance M-6010-R302/S302/R351/R352/R353/R354/R355/S351/V351/W351/BOSS302/BOSS351 cylinder blocks
- Package of 10



CAMSHAFT BEARINGS - ROLLER
 (SOLD IN ENGINE SETS)
 M-6261-D351



These low-friction, roller camshaft bearings only require oil "splash" lubrication. Oil feed holes can be totally blocked off to help reduce oil aeration and windage losses. Engine block must be machined to accept bearing size shown in chart.



NOTE: The 351 cam journals are NOT production dimensions. These roller bearings require an SAE 8620 steel camshaft.

PART NUMBER	APPLICATION	O.D. DESCRIPTION	I.D. DESCRIPTION	LENGTH
M-6261-D351	351 Ford	(1-4) 2.48" (5) 2.28"	(1-4) 2.165" (5) 1.969"	787"

NOTE: Requires camshaft retainer plate modifications.

CAMSHAFT BEARINGS
 M-6261-J351



- Fits 302/351 Ford Performance blocks
- Common outer and inner diameter replacement cam bearings for use in M-6010-R302/S302/R351/R352/S351/V351/W351/R451/R452/R453/B302BB/BOSS302/BOSS35192/BOSS35195/BOSS351BB cast iron blocks
- Use with custom ground common O.D. camshaft



BOSS BLOCK CYLINDER HEAD STUD KIT
 M-6014-BOSS



- 1/2" cylinder head studs required for installation of the Ford Performance M-6049-X306/X307/X2/Z304DA/Z2 heads onto the M-6010-BOSS302, M-6010-BOSS35192, M-6010-B35192BB blocks
- Includes 12-point nuts and hardened washers
- Sold in engine sets

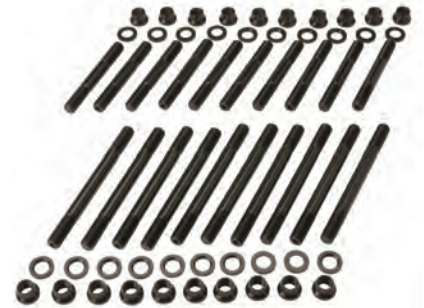

NOTE: Check header-to-head stud and nut for clearance.

CYLINDER HEAD STUD KIT
 M-6014-Z304



- 1/2" cylinder head studs required when installing M-6049-Z304/Z304A/Z304D/Z304DA heads on a 351W block (except BOSS 351 block)
- 1/2" diameter studs with 12-point nuts and hardened washers
- Sold in engine sets



PUSHROD ENGINES / COMPONENTS (CONTINUED)

BOSS BLOCK HEAD BOLT SET

M-6065-BOSS



- 1/2" ARP® cylinder head bolts required for installation of the Ford Performance M-6049-X306/X307/X2/Z304DA/Z2 heads onto the M-6010-BOSS302, M-6010-B302BB, M-6010-BOSS35195, M-6010-BOSS35192, M-6010-BOSS351BB blocks

- Includes hardened washers
- Sold in engine sets



HEAD BOLT KIT

M-6065-D289



- Use when installing stock 351W, Ford Performance cast iron M-6049-L302/L303 or Ford Performance aluminum M-6049-Y302/Y303/X302/X303/X304/X305/X306/X307 head on 289/302 blocks
- Kit features 20 ARP® cylinder head bolts with 7/16" diameter thread
- Includes 20 special stepped washers
- Sold in engine sets



302-351W CAMSHAFT THRUST PLATE



PART NUMBER	APPLICATION	DESCRIPTION
M-6269-A302	302/351W	<ul style="list-style-type: none"> • Production replacement for 302 and 351W engines • For use with flat tappet and hydraulic roller camshafts • Designed for timing chain sets requiring .250" thick retainer plate • Not for use with steel cam gears
M-6269-A351	302/351 Ford Performance	<ul style="list-style-type: none"> • Steel replacement for production cast iron thrust plate for severe service • Use with steel timing chain sprocket • Required when using M-6268-B302 Timing Chain Set



M-6269-A351 shown

HIGH STRENGTH FORGED STEEL 3.40" STROKER CRANKSHAFT

M-6303-C340

Fits 302 production and Ford Performance cylinder blocks. Stock 2.1232" rod journal diameters. Use with M-6200-D50 "Sportsman" rods (5.40" long) and 1.090" CD pistons in standard 302 block for 347 cu in.

Features:

- Lightening holes
- Rounded CW leading edge, tapered trailing edge
- Rod and main journals are nitrided and polished
- Requires custom pistons, rods and balancing



⚠ WARNING: Cancer www.P65Warnings.ca.gov

CRANKSHAFT DAMPERS

- Ford Performance crankshaft dampers are used on most Ford Performance push rod crate engines
- Billet steel construction, meets SFI 18-1 requirements
- Elastomer-style harmonic vibration damper
- Laser-etched timing marks and "Ford Racing" logo
- 3- and 4-bolt pulley mounting holes
- Clear powdercoat finish

PART NUMBER	ENGINE	BALANCE	NOTES	MASS (LBS)
M-6316-A50	302 (1981-1993)	50 oz-in	Meets SFI 18-1 ①②③⑤	12.1
M-6316-C351	302/351W	28.2 oz-in	Meets SFI 18-1 ①②③⑥	11.5
M-6316-D302	302/351W	Neutral	Meets SFI 18-1 ③⑥	10.6

NOTES:

- ① Damper has removable weight that allows use as a neutral balance unit for internally balanced crankshafts. 1994-1995 Mustang and 1994-2001 Explorer requires modification
- ② Does not clear early timing chain cover with rear installed seal
- ③ 3.000" overall length
- ④ Tuned for use on 521 crate engine
- ⑤ Passenger side 11 o'clock timing marks only
- ⑥ Passenger side 11 o'clock timing marks and driver side 2 o'clock timing marks



M-6316-A50



M-6316-C351

5.0L CRANKSHAFT DAMPER KIT

M-6316-M50



- New stock replacement crankshaft damper most 1981-1995 5.0L/302 engines
- 50 oz-in balance factor
- Crankshaft damper overall length is 3.950"
- 4-bolt pulley pattern
- Kit includes E4TZ-A Crankshaft Damper and FITZ-A Timing Pointer



CRANKSHAFT PULLEY SPACERS



Use these crank pulley spacers with Ford Performance M-6316-C351/A50/D302 crank dampers to achieve proper belt alignment on late model 302 and 351 Windsor engines.

PART NUMBER	ENGINE	CRANK PULLEY BOLT PATTERN	SPACER THICKNESS
M-8510-A351	302/351W	4	.350"
M-8510-B351	302/351W	4	.950"
M-8510-C351	302/351W	4	.875"
M-8510-D351	302/351W	4	.909"

INSTALLATION NOTES

Early 3-bolt crank pulleys generally bolt directly to the damper with flanged pulley pilot (damper is drilled for 3- and 4-bolt patterns).

Pulley alignment should be checked and any misalignment corrected with the proper thickness spacer.

Photo may vary.



351W HIGH-VOLUME OIL PUMP

M-6600-B3



- Fits 1969-1997 351W
- High volume – standard pressure
- Use with Ford Performance BOSS 351 blocks
- Requires bolt-on pickup (not included)
- Due to the higher pumping capacity of this pump, it is not recommended for use with a stock capacity oil pan
- This pump will not fit stock rear sump oil pans because of its larger size
- Recommended with M-6675-DRS351 and M-6675-FT351 oil pans



289/302 HIGH-VOLUME OIL PUMP

M-6600-D2



- Fits 1963-2000 289/302
- High volume – standard pressure
- Use with Ford Performance BOSS 302 block
- Used in Ford Performance 347 and 363 crate engines
- Requires bolt-on pickup (not included)
- Due to the higher pumping capacity of this pump, it is not recommended for use with a stock capacity oil pan
- This pump will not fit stock rear sump oil pans because of its larger size
- Recommended with M-6675-DRS302 and M-6675-FT302 oil pans



OIL PUMP DRIVE SHAFT



- M-6605-A341 Fits 351W & all Ford Performance BOSS 351 blocks
- M-6605-B302 Fits 289-302 EFI- and non-EFI & Ford Performance BOSS 302 blocks

- Heavy duty
- Chrome moly steel
- Centerless ground



BOSS 302 OIL PICKUP TUBE

M-6622-BOSS302



- For use with M-6010-BOSS302 block
- Clears 4-bolt main caps
- Fits stock Fox body Mustang pans
- Fits F1SE pans used on 1991-1995 Mustang



351 DEEP REAR SUMP OIL PICKUP TUBE FOR Z351 ALUMINUM BLOCK

M-6622-DRS351A

- Fits M-6675-DRS351 Deep Rear Sump Oil Pan when used with the M-6010-Z351 Aluminum Block
- High-flow funnel-style pickup same as used on Mustang Cobra 4.6L 4V engines
- Thin wire screen delivers more than twice the flow area compared to many aftermarket pickup screens
- Thin wall 3/4" diameter tubing reduces vibration fatigue
- Quality built-in precision fixtures for a consistent OEM-level fit



ENGINE SWAP OIL PAN KITS

PART NUMBER	SUMP	CAPACITY	FINISH
M-6675-A50	Rear	5 QT	Painted

302/5.0L oil pan kit.

Includes rear sump oil pan, dipstick, dipstick tube, pickup and main cap stud. Ideal for engine swaps. Fits 1979-1995 Mustang and Fox chassis vehicles. Fits 1983-2001 production blocks.

NOTE: Does not have provision for low oil sender. Fasteners not included.



PART NUMBER	SUMP	CAPACITY	FINISH
M-6675-A58	Rear	5 QT	Painted

351W/5.8L oil pan kit.

Includes rear sump oil pan, dipstick, dipstick tube, pickup and main cap stud. Ideal for engine swaps. Fits 1979-1995 Mustang and Fox chassis vehicles. Fits 1969-1997 production blocks. Fasteners not included.



PUSHROD ENGINES / COMPONENTS (CONTINUED)

HIGH-CAPACITY PERFORMANCE OIL PANS

Designed by Ford Performance for use on its crate engines, these oil pans are constructed to deliver power and durability.

Features include:

- Full-length scraper to direct oil away from the crankshaft
- Full-length bolt in louvered windage tray to control oil
- Baffling and trap doors in the sump to keep the pickup submerged during performance driving
- Semi-gloss black powdercoat finish
- Laser-cut and TIG welded in precision fixtures for consistent OEM-level fit

REAR SUMP

302 DEEP REAR SUMP OIL PAN
M-6675-DRS302

- Fits standard 302 Windsor block oil pan bolt pattern
- 7 qt capacity
- Rear sump depth is 9.1" – rear sump width is 8.7" – front sump depth is 6.7"
- Includes 3/8" NPT bung to mount an oil temperature sending unit
- Includes 3/8" NPT access hole to adjust oil pump spring pressure
- Designed to clear 4-bolt main cap Ford Performance BOSS 302 blocks
- Used on Ford Performance M-6007-Z363RT Crate Engine
- Use M-6622-DRS302 Pickup

351 DEEP REAR SUMP OIL PAN
M-6675-DRS351

- Fits standard 351 Windsor block oil pan bolt pattern
- 7 qt capacity
- Rear sump depth is 9.1" – rear sump width is 8.7" – front sump depth is 6.7"
- Includes 3/8" NPT bung to mount an oil temperature sending unit
- Includes 3/8" NPT access hole to adjust oil pump spring pressure
- Used on Ford Performance M-6007-Z427FRT and M-6007-Z427ART crate engines
- Use M-6622-DRS351 Pickup

M-6675-DRS351
DEEP REAR SUMP OIL PICKUP TUBES
M-6622-DRS302 Fits Pan M-6675-DRS302

M-6622-DRS351 Fits Pan M-6675-DRS351

- High-flow funnel-style pickup same as used on Mustang Cobra 4.6L 4V engines
- Thin wire screen delivers more than twice the flow area compared to many aftermarket pickup screens
- Thin wall 3/4" diameter tubing reduces vibration fatigue
- Quality built-in precision fixtures for a consistent OEM level fit

M-6622-DRS351 shown

FRONT SUMP

302 FRONT T-SUMP RACING OIL PAN
M-6675-FT302

- Fits standard 302 Windsor block oil pan bolt pattern
- 7 qt capacity
- Sump depth is 7.5" – T-sump width is 12.1" – T-sump length from the front of the pan is 10.6"
- Includes 3/8" NPT bung to mount an oil temperature sending unit
- Includes 3/8" NPT access hole to adjust oil pump spring pressure
- Designed to clear 4-bolt main cap Ford Performance BOSS 302 blocks
- Used on Ford Performance M-6007-Z2363FT Crate Engine
- Use M-6622-FT302 Pickup

351 FRONT T-SUMP RACING OIL PAN
M-6675-FT351

- Fits standard 351 Windsor block oil pan bolt pattern
- 9 qt capacity
- Sump depth is 8.1" – T-sump width is 12.15" – T-sump length from the front of the pan is 10.4"
- Includes 3/8" NPT bung to mount an oil temperature sending unit
- Includes 3/8" NPT access hole to adjust oil pump spring pressure
- Designed to clear 4-bolt main cap Ford Performance BOSS 351 blocks
- Used on Ford Performance M-6007-Z427FFT Crate Engine
- Use M-6622-FT351 Pickup

M-6675-FT302
FRONT SUMP OIL PICKUP TUBES
M-6622-FT302 Fits Pan M-6675-FT302

M-6622-FT351 Fits Pan M-6675-FT351

- For use with production block
- Fits front sump oil pans
- High-flow funnel-style pickup same as used on Mustang Cobra 4.6L 4V engines
- Thin wire screen delivers more than twice the flow area compared to many aftermarket pickup screens
- Thin wall 3/4" diameter tubing reduces vibration fatigue
- Quality built-in precision fixtures for a consistent OEM level fit

M-6622-FT302

FORD RACING HIGH PERFORMANCE OIL FILTER



- Synthetic – polymer/cellulose – fiber blend media
- Heavy-gauge base and canister for higher burst strength and impulse fatigue resistance
- High-quality silicone anti-drainback valve
- Nonstick sealing gasket for ease of installation and removal
- Long life with standard and synthetic motor oils
- Up to 50% more filtering capacity than standard filters
- Improved filtering efficiency
- This technology is only available through Ford Performance Parts



CM-6731-FL1A shown

Motorcraft® PART NUMBER	PERFORMANCE FILTER	PART NUMBER
FL1A	CM-6731-FL1A (Single)	M-6731-FL1A (Case of 12)
FL820S	CM-6731-FL820 (Single)	M-6731-FL820 (Case of 12)

NOTE: Check Ford Performance Distributors for single filter part numbers.
NOTE: FL820 can be used in many FL500 applications.

289-302 SB OIL PAN REINFORCEMENT RAILS

Precision laser-cut steel rails help minimize the chance of oil pan leaks on 289-302 based small block Ford engines. These reinforcement rails are designed to be used with flat flange oil pans and M-6710-A50 One-Piece Silicone Rubber Oil Pan Gasket. These reinforcement rails are used on all Ford Performance 302/347/363 crate engines.



- Includes left and right 3/16" steel precision laser-cut reinforcement rails
- Fits original oil pan flange
- M-6710-A50 Oil Pan Gasket recommended
- Longer oil pan bolts are recommended

351W OIL PAN REINFORCEMENT RAILS

Precision laser-cut steel rails help minimize the chance of oil pan leaks on 351W based small block Ford engines. These reinforcement rails are designed to be used with flat flange oil pans and M-6710-A351 One-Piece Silicone Rubber Oil Pan Gasket. These reinforcement rails are used on all Ford Performance 427-460 CID 351W-based small block crate engines.



- Includes left and right 3/16" steel precision stamped laser-cut reinforcement rails
- Fits original oil pan flange
- M-6710-A351 Oil Pan Gasket recommended
- Longer oil pan bolts are recommended

ENGINE OIL DIPSTICK/TUBE

- Fits 1983-1993 5.0L Mustang
- Chrome-plated tube with bracket



WARNING: Cancer www.P65Warnings.ca.gov

PUSH ROD V8 90 DEGREE OIL FILTER ADAPTER



M-6880-A50

- Adapter screws into original oil filter location and rotates filter toward front of engine to provide clearance for engine swaps and chassis modifications



- Fits most Ford small and big block push rod engines that use Ford Racing CM-6731-FL1A or Motorcraft® FL-1A Oil Filter (filter sold separately)
- Replacement O-rings, Fel-Pro® Part Nos. FP3330537 (small) and 72494 (large)

NEW 302/351W "Z" ALUMINUM CNC PORTED, ASSEMBLED CYLINDER HEAD



- Fits 302/351 Windsor engines
- Intake and Exhaust airflow increased approximately 10% over Ford Performance "Z" heads
- This cylinder head was designed using Solid Modeling Technology
- Cast from prime A356 T6 aluminum
- 59cc CNC'd combustion chamber
- Heads have CNC high-flow ports
- 20 degree inline valves
- Valve sizes: 2.08-inch intake and 1.60-inch exhaust
- Competition valve job and bowl blending
- Steel alloy intake and exhaust valve seats installed
- Manganese-bronze 11/32" valve guides installed with finished ID
- Bare head weighs 27 lbs. Accepts both tapered seat and gasket style 14 mm spark plugs (Motorcraft AGSP-32-C, Autolite 3924, 3925)
- Requires guide plate M-6566-Z304D (not included)
- Requires 7/16" screw-in studs (not included)
- Requires 1.65:1 or 1.5:1 ratio roller rocker arms with .150" offset intake pushrod cup (not included-recommend Crower 72813X1 offset intake rocker arm)
- Uses M-6505-B304 exhaust valve
- Raised exhaust port exit, custom headers may be required
- Check your intake manifold for port match; not all intakes are compatible due to the tall high-flow ports
- Requires M-9439-ZP Intake manifold gasket
- Uses Fel-Pro® exhaust gasket part number 1487
- Fel-Pro® VS13264T valve cover gasket recommended
- Check piston to valve clearance including radial valve clearance before installing these cylinder heads on your engine
- Uses Fel-Pro® exhaust gasket part number 1487

PUSHROD ENGINES / COMPONENTS (CONTINUED)

NEW 302/351W "X2" STREET CRUISER ASSEMBLED ALUMINUM CYLINDER HEAD 64CC

M-6049-X2

New and improved "X2" cylinder head is manufactured from new tooling, machined, and assembled with premium hardware.

This provides a fast, easy way to bolt on significant horsepower to your street cruiser package!

- For use on 289/302/351 Windsor-style engines
- High quality original equipment style 356-T6 aluminum castings, precision machined, and assembled with premium components
- Includes Ford Performance M-6507-J302 intake valves, M-6505-G302 exhaust valves, and PAC® 1219X Ovate Beehive valve springs
- Feature 10-degree locks, steel valve spring retainers and stock valve seals
- High temperature exhaust valve seats
- Includes bronze guides
- Features wider valve cover gasket sealing rail to prevent leaks
- Machined for gasket seat spark plug
- Compatible with all Ford Performance roller camshafts and aftermarket hydraulic roller camshafts up to .600" lift
- Works with many aftermarket intake manifolds, headers, and valve train components
- Compatible with bolt down rockers 1.6-1.7 ratio, always check rocker arm clearance to valve springs with production rocker arms
- Depending on lifter preload, Ford Performance Rocker Shim Kits M-6529-A302 or M-6529-B302 may be required
- Each aluminum head weighs approximately 25 lbs. lighter than each production cast iron head
- Each head is leak tested prior to assembly

Specifications:

- Combustion chamber volume 64cc
- Intake port volume 188cc
- Exhaust port volume 63cc
- Intake flows approximately 230 cfm at .600" lift (at 28" of H2O)
- Exhaust flows approximately 160 cfm at .600" lift (at 28" of H2O)
- Premium stainless steel valves – 1.94" intake and 1.54" exhaust
- Closed spring pressure is 145# @ 1.800"
- Open spring pressure is 358# @ 1.175"



NOTES:

- Designed to be used on Ford Performance BOSS blocks; M-6010-BOSS302, M-6010-B302BB, M-6010-BOSS35195, M-6010-BOSS35192 and M-6010-BOSS351BB
- Use Ford Performance M-6065-BOSS Head Bolt Set or Ford Performance M-6014-BOSS Head Stud Kit
- Use Ford Performance Head Gasket M-6051-CP331 or M-6051-S331 or for "Big Bore" application, use M-6051-R351
- Must use Ford Performance M-6065-D289 Head Bolt Kit to install heads on 289/302 production blocks
- Ford Performance "X2" heads use either GT-40 or aftermarket intake manifolds. Check manifold for port match; not all intakes are compatible due to tall high-flow intake ports
- "X2" cylinder heads use Motorcraft® AGSP-32C spark plugs
- Use Fel-Pro® exhaust gasket part number 1415
- Will not fit 1986 5.0L with flat-top pistons unless pistons are notched for valve relief
- Cylinder heads are sold individually

Z2 289/302/351W ALUMINUM HEAD WITH "VELOCITY VANE"

M-6049-Z2

This aluminum small block Ford cylinder head features an advanced "Velocity Vane" intake port design that delivers outstanding street/strip power. Developed with the aid of advanced computer aided engineering simulation tools, the unique "Velocity Vane" intake port design improves power throughout the rpm range. This high-performance aluminum cylinder head is a direct bolt-on for Ford 289/302/351W engines and retains OEM exhaust, intake and accessory mounting locations.

- Fits 289/302/351 Windsor engines
- Cast from prime 356-T6 aluminum
- Heads retain Ford OEM intake and exhaust port location and flange
- Intake ports feature a unique "Velocity Vane" in port floor to direct airflow around the valve stem – that leads to more horsepower and torque throughout the full power range
- 20° inline valve angle
- Premium stainless steel valves – 2.05" intake and 1.60" exhaust
- PAC 1219X conical-style valve springs with machined retainers and 10° machined valve locks. Most hydraulic cams can be used with these springs
- Valve spring closed pressure – 145 lbs @ 1.800"
- Valve spring open pressure – 358 lbs @ 1.175"
- Coil bind @ 1.100", 0.650" max lift
- Includes laser-cut guide plates for use with 5/16" push rods and 7/16" rocker studs
- Steel alloy intake and exhaust valve seats



- Manganese-bronze valve guides
- 63 cc combustion chamber
- Uses gasket style 14 mm spark plugs
- Uses standard roller rocker – M-6564-K351 recommended
- Check piston-to-valve clearance, including radial valve clearance, before installing these cylinder heads on your engine
- Uses M-9439-A50 Intake Gasket and Fel-Pro® exhaust gasket Part No. 1415



302/351W "Z-HEAD" ALUMINUM HEAD

M-6049-Z304D	Bare 63CC
M-6049-Z304DA	Assembled 63CC
M-6049-Z304D7	63CC with 7 mm valves
M-6049-Z304DA7	Assembled 63CC with 7 mm Valves
M-6049-Z304P	Bare 59CC

- Fits 302/351 Windsor engines
- Cast from prime A356 T6 aluminum
- Heads are cast with high-flow ports
- 20° inline valves
- Premium stainless steel 2.02" M-6507-A304 Intake and 1.60" M-6505-B304 Exhaust Valves
- Uses PAC 1219X conical-style valve springs with machined retainers and machined valve locks. Most hydraulic cams can be used with these springs
- Valve spring closed pressure – 145 lbs @1.800"
- Valve spring open pressure – 358 lbs @ 1.175"
- Includes laser-cut M-6566-Z304D Guide Plates for use with 5/16" push rods and 7/16" rocker studs (ARP® DRP154 rocker stud)
- Steel alloy intake and exhaust valve seats
- Manganese-bronze valve guides
- 63 cc CNC'd combustion chamber (M-6049-Z30HP has 59 cc combustion chamber)
- Intake port volume as cast: 204 cc
- Exhaust port volume as cast: 85 cc
- Accepts both tapered seat and gasket style 14 mm spark plugs (Motorcraft® AGSP-32-PP, Autolite® 3924, 3925)
- Requires M-6564-F351 1.65:1 or M-6564-G351C 1.5:1 ratio roller rocker arms with .150" offset intake push rod cup (not included)
- Raised exhaust port exit, custom headers may be required
- Ford Performance M-9439-A50 Intake Manifold Gasket recommended



EXHAUST / INTAKE VALVES — SINGLE GROOVE

PART NUMBER	APPLICATION	HEAD DIAMETER	TIP LENGTH	TOTAL LENGTH	STEM DIAMETER	GROOVE TYPE	VALVE WEIGHT	DESCRIPTION
EXHAUST VALVE (SOLD INDIVIDUALLY)								
M-6505-G302	GT-40 Iron Head M-6049-L302/303 Ford Performance Aluminum Head M-6049-X306/X307	1.540"	.383"	5.078"	11/32"	Square cut	120 grams	Premium stainless steel, swirl polished, under-cut stem

INTAKE VALVE (SOLD INDIVIDUALLY)								
M-6507-J302	GT-40 Aluminum Head, M-6049-Y302/Y303/X302/ X303/ X304/X305/X306/X307	1.940"	.383"	5.078"	11/32"	Square cut	113.2 grams	Premium stainless steel, swirl polished, under-cut stem



M-6505-G302



M-6507-J302

BRONZE VALVE GUIDE KIT

M-6510-XRBVG

- Sold in sets of 4
- Replacement bronze valve guides for the M-6049-Y302/Y303/X302/X303/X304/X305/X306/X307 heads
- .557" outside diameter
- Inside diameter designed for 11/32" valves, HONING REQUIRED



VALVE STEM SEALS POSITIVE-TYPE, GUIDE-MOUNTED SEAL

PART NUMBER	TYPE	APPLICATION NOTES	DESCRIPTION
M-6571-A50	Rubber ①	GT-40 cylinder heads. No machining required	Pkg. of 8 intake and 8 exhaust seals

NOTES: ① Fits most production .550" - .570" diameter guides.



PUSHROD ENGINES / COMPONENTS (CONTINUED)
EXHAUST VALVES 302 / 351W

PART NUMBER	APPLICATION	HEAD DIAMETER	TIP LENGTH	TOTAL LENGTH	STEM DIAMETER	GROOVE TYPE	VALVE WEIGHT	DESCRIPTION
M-6505-B304	M-6049-Z304D/Z304DA	1.600"	.290"	5.365"	11/32"	Square cut	120 grams	Premium stainless steel and swirl polished
M-6505-D3047	M-6049-Z304DA7	1.600"	.340"	5.365"	7 mm	Bead lock	95.4 grams	Premium stainless steel and swirl polished

INTAKE VALVES 302 / 351W

PART NUMBER	APPLICATION	HEAD DIAMETER	TIP LENGTH	TOTAL LENGTH	STEM DIAMETER	GROOVE TYPE	VALVE WEIGHT	DESCRIPTION
M-6507-A304	M-6049-Z304/Z304D/ Z304DA	2.020"	.290"	5.340"	11/32"	Square cut	122 grams	Premium stainless steel and swirl polished
M-6507-D3047	M-6049-Z304/Z304DA7	2.020"	.325"	5.340"	7 mm	Bead lock	103 grams	Premium stainless steel and swirl polished

Z304 VALVE PUSH ROD GUIDE PLATE – FITS TWO CYLINDER HEADS

PART NUMBER	CYLINDER HEAD	PUSHROD DIAMETER
M-6566-Z304D	M-6049-Z304D/Z304DA	.3125"

Valve push rod guide plate kits fit Ford Performance Z304 cylinder heads.

- Use with mechanical cams, threaded stud, adjustable (non-rail) rocker arms and hardened push rods
- .3125" push rod diameter
- Sold in package of eight, for two cylinder heads
- Fits Ford Performance M-6049-Z340D, M-6049-Z304DA, M-6049-Z304DA7, M-6049-Z304PA cylinder head



NOTE: May require modification for use with roller rockers

NEW SCJ VALVE PUSH ROD GUIDE PLATE – FITS ONE CYLINDER HEAD

M-6566-SCJA

Valve push rod guide plate kits fit Ford Performance Super Cobra Jet cylinder head.

- Use with mechanical cams, threaded stud, adjustable (non-rail) rocker arms and hardened push rods
- .375" push rod diameter

- Sold in package of four, for one cylinder head
- Fits Ford Performance M-6049-SCJ, M-6049-SCJA, M-6049-SCJB

NOTE: May require modification for use with roller rockers.

PAC 1219X BEEHIVE VALVE SPRING

M-6513-1219X

- PAC 1219X valve spring as used on M-6049-Z304DA Cylinder Heads.
- O.D. large end – 1.207"
- I.D. small end – 0.650"

- Installed height (valve closed) – 145 lbs @ 1.800"
- Open valve (valve open) – 358 lbs @ 1.175"
- Spring rate 340
- Max coil bind – 1.100"

VALVE SPRING RETAINERS

M-6514-A50

APPLICATION VALVE	SPRING	DESC.	SPRING O.D.	RETAINER O.D.	STEP DIMENSIONS
Single lock groove. 11/32" dia. stem	M-6513-A50 M-6513-B351 M-6049-N351 and all GT-40 ① ②	7° machined steel	1.500"	1.375"	1st Step: 1.060" 2nd Step: .675"

NOTES: ① Use of M-6514-B50 Retainers on 1979-1995 production valves of 5.0L (302) HO and production GT-40 engines eliminates exhaust rotators and will result in 1.800" intake and exhaust spring "installed height." ② With Ford Performance stainless steel valves.



FORD PERFORMANCE CAMSHAFTS

SMALL BLOCK V8 HYDRAULIC ROLLER TAPPET CAMSHAFTS



The Ford Performance Camshaft Specification chart below describes individual cams currently available from Ford Performance.

PART NUMBER	ENGINE	ROCKER RATIO	INTAKE EVENTS (.050")		EXHAUST EVENTS (.050")		DURATION (SAE)		LIFT (INCHES)		LOBE CENTER	
			OPEN	CLOSE	OPEN	CLOSE	INT.	EXH.	LOBE	VALVE	INT.	EXH.
M-6250-B303 ① ② ③ ⑥	1985 and later 302 roller cam	1.60	5° BTC	39° ABC	49° BBC	5° BTC	284°	284°	.300 I	.480 I	107°	117°
							224°	224°	.300 E	.480 E		
M-6250-E303 ① ② ③ ⑥	1985 and later 302 roller cam	1.60	0° BTC	40° ABC	40° BBC	0° BTC	282°	282°	.311 I	.498 I	110°	110°
							220°	220°	.311 E	.498 E		
M-6250-F303 ① ② ③ ④ ⑥ ⑦	1985 and later 302 roller cam	1.60	4° BTC	42° ABC	52° BBC	6° BTC	288°	288°	.320 I	.512 I	109°	119°
							226°	226°	.320 E	.512 E		
M-6250-X303 ① ② ③ ④ ⑥ ⑧	1985 and later 302 roller cam	1.60	5° BTC	39° ABC	49° BBC	5° BTC	286°	286°	.339 I	.542 I	107°	117°
							224°	224°	.339 E	.542 E		



The legendary B303 cam developed by Ford Performance for the 5.0L Fox body Mustang. This cam provides a noticeable power improvement and lumpy idle while maintaining good driveability with a manual transmission. Works well with carburetors or mass air fuel injection.

- Fits 1985 and later 302 roller cam blocks
- Will also fit 1963-1984 non-roller cam 289-302 blocks when used with M-6500-T58 Hydraulic Roller Lifters
- Will also fit 1994-1997 351W blocks with factory roller cam
- Will also fit 1969-1993 non-roller cam 351W blocks when used with M-6500-T58 Hydraulic Roller Lifters
- Requires upgraded valve springs. For stock cylinder head applications use M-6513-A50 Valve Springs installed at 1.820". For aftermarket cylinder heads, M-6513-BH recommended
- Valve spring requirements: 120 lbs valve seat pressure minimum, 295 lbs open
- On EFI engines, performance camshafts work only with mass air induction systems. Will not work with Explorer EEC-V EFI or speed density EFI systems
- Also fits 1994-1997 351W with factory roller cam when used with mass air EFI
- Stock 5.0L HO cam advertised specs are 266°/266° duration, 0.444"/0.444" lift
- Higher stall torque converter recommended for automatic transmissions

NOTE: Camshaft intake and exhaust valve events are measured at 0.050" tappet lift. The duration figures in the shaded area are taken at 0.050" tappet lift. This is useful to check the cam with a degree wheel during installation. The solid color is advertised duration. For comparison purposes, add intake and exhaust lobe centers and divide by 2 to calculate "camshaft center line" specification for Ford Racing camshafts.

NOTES:

- ① On EFI engines, performance camshafts work only with mass air induction systems. Will not work with Explorer EEC-V EFI.
- ② Also fits 1994-1997 351W with factory roller cam when used with mass air EFI.
- ③ Stock 5.0L HO cam advertised specs are 266°/266° duration, 0.444"/0.444" lift.
- ④ May require piston modification for piston-to-valve clearance. Valve clearance should be checked.
- ⑤ May require longer pushrods.
- ⑥ High-stall torque converter recommended for automatic transmissions.
- ⑦ Great for superchargers. Manual transmission recommended.
- ⑧ Good torque and power up to 6200 rpm. Manual transmission recommended.

⚠ WARNING: Cancer www.P65Warnings.ca.gov

ROLLER CAM CONVERSION KIT

M-6253-A50



- Fits 1985-2001 302, 1994-1997 351W
- Fits Ford Performance BOSS 302 and BOSS 351 blocks
- This kit is designed to help engine builders assemble Ford Performance BOSS blocks into complete engines
- Kit includes 8 hydraulic roller lifter powdered metal tie bars, 1 retainer plate and 2 bolts
- Not for use in production non-roller cam blocks

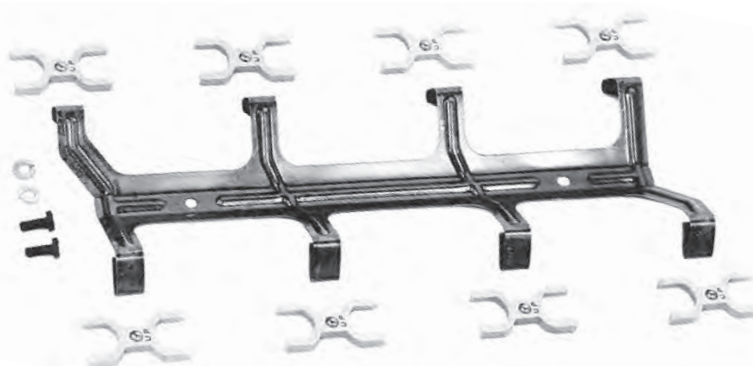

PUSHROD ENGINES / COMPONENTS (CONTINUED)



DOUBLE ROLLER TIMING CHAIN SET – CAST IRON GEAR

The crank sprocket has 2-degree increments for timing adjustment of up to 8 degrees retarded, 8 degrees advanced or straight-up (no advance or retard). Chain is rugged, double-row type with oversized .250" rollers that deliver long life and reliability.



Full Roller Timing Chain and Sprocket Set

PART NUMBER	APPLICATION	DESCRIPTION
M-6268-A302	289/302/351W	Full roller chain with 9-position multi-index crank sprocket. Includes M-6269-A302 Thrust Plate and 1" camshaft dowel pin. Cam sprocket is made from cast iron. Crank sprocket is made from induction-hardened, billet steel. Compatible with one-piece M-6287-B302 Fuel Pump Eccentric. Depending on camshaft manufacturer and application, other dowel pin length may be required. Not compatible with two-piece fuel pump eccentric.
M-6268-B302	289/302/351W	Same as M-6268-A302, except cam sprocket is made from steel for maximum competition engines. Use with M-6269-A351 Hardened Thrust Plate.
M-6287-B302	289/302/351W	Eccentric for M-6268-B302 and A302 Kits – mechanical fuel pump drive, with 3/8" bolt.
M-6287-C302	289/302/351W	Eccentric for M-6268-B302 and A302 Kits – mechanical fuel pump drive, with 7/16" bolt.

HYDRAULIC ROLLER CAM LIFTERS

PART NUMBER	APPLICATION	TYPE
M-6500-R302	All Roller Small Block	Hydraulic roller tappet OEM replacement
M-6500-R302H	All Roller Small Block	High-performance hydraulic roller tappet recommended for performance and racing applications. Direct OEM lifter size replacement



M-6500-R302 DESCRIPTION

- Direct replacement for 302/351W production small block hydraulic roller lifter applications
- Use M-6500-R302H High-Performance Roller Cam Lifters for higher rpm and severe duty applications
- Uses production dog-bone type tie bars and retainer plate components included in M-6253-A50 Roller Cam Conversion Kit
- Sold in a set of 16 lifters

⚠ WARNING: Cancer www.P65Warnings.ca.gov

M-6500-R302H DESCRIPTION

It's not often that little changes can deliver big results – but in the case of the Ford Performance R302H Lifter, that's exactly the result.

Before getting into the technical details of the lifter, here's the background on why and how this special lifter was developed by the engineers at Ford Performance. Circle track racers who use the production hydraulic roller lifter in 347 crate engines reported that their engine seemed to lose power during long green flag runs. Dyno testing by Ford Performance engineers confirmed that – and showed a dramatic performance fall off over 6000 rpm with hot oil temperatures. The problem was traced to the piddle valve check ball, which would become unseated at high rpm when the oil got hot. The fix was a lighter-weight ceramic piddle valve check ball combined with a higher-rate piddle valve spring to keep it seated. The results of these two small changes were impressive – and noticeable by the racers. The power range was extended 300-400 rpm in hot operating conditions – and more importantly, the performance fall off on those long runs was gone.

This unique lifter construction for a drop-in hydraulic roller lifter is an exclusive from Ford Performance and fits any small block Ford roller cam application. While the R302H was developed specifically for racing conditions, it's the right choice when assembling a high-performance small block that uses a hydraulic roller camshaft.

- High-performance hydraulic roller tappet recommended for performance and racing applications
- Modified OEM lifter features ceramic check ball and higher rate piddle valve spring to improve performance at higher rpms and higher oil temperatures
- Ford Performance dyno tests have shown 300 to 400 rpm increase in rpm range over stock OEM-type hydraulic roller lifter in Ford Performance sealed crate engines
- Direct replacement for the OEM small block hydraulic roller lifter applications
- Uses OEM dog-bone type tie bars and retainer plate components included in M-6253-A50 Roller Cam Conversion Kit
- Sold in a set of 16 lifters

⚠ WARNING: Cancer www.P65Warnings.ca.gov

HIGH PERFORMANCE HARDENED STEEL LIFTER CUP – SET OF 16

M-6500-R302HLC

- Tool steel push rod cup for the M-6500-R302 or M-6500-R302H hydraulic roller lifter
- Intended for high rpm and competition use
- Set of 16 cups

⚠ WARNING: Cancer www.P65Warnings.ca.gov



HI-PERFORMANCE ENGINE GASKET SET M-6003-A50



- Fits 289/302/351W (1963-2001)
- Manufactured to Ford specs by Fel-Pro®
- Kit includes production-style graphite head gaskets and Print-O-Seal® intake gasket
- Includes four-piece oil pan gasket and valve cover gaskets
- Also includes front and rear oil seals plus most gaskets for a complete rebuild

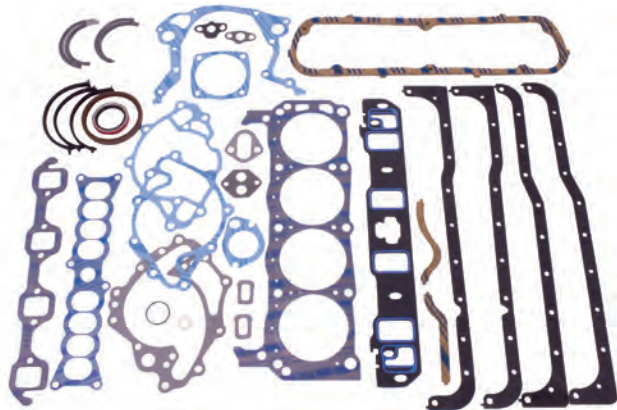

NOTE: Does not include one-piece rear main for 351W, use M-6701-B351. Head gaskets not for use with Ford Performance BOSS blocks. Intake gaskets fit base production heads only.

VALVE ROCKER ARM PEDESTAL SHIM KIT M-6529-A302



- Fits 302 and 351 pedestal-style cylinder heads, like Ford Performance M-6049-X306 and M-6049-X307
- Use with bolt-on M-6564-A50, M-6564-B351 and M-6564-C351 roller rocker arms to obtain correct lifter pre-load
- Shim kit includes 16 thin and 16 thick shims, which can be used to reduce lifter pre-load by 0.030" (thin shim), 0.060" (thick shim), or 0.090" (thin plus thick shim)

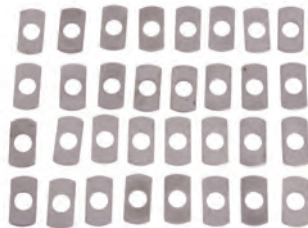

ROCKER ARM PEDESTAL SHIM KIT M-6529-B302

- Fits 302 and 351 pedestal-style cylinder heads, like Ford Performance M-6049-X306 and M-6049-X307
- Use with bolt-on M-6564-A50 and M-6564-B351 roller rocker arms to obtain correct lifter pre-load
- Shim kit is used to reduce lifter pre-load and includes 16 each of the following thickness shims: .010", .020", .030" and .040"



ROCKER CHANNEL KIT M-6588-A50



- Fits 5.0L/5.8L production heads and GT-40 heads
- For production stamped steel and Ford Performance bolt-on roller rockers
- Ties two rocker arms together for proper alignment

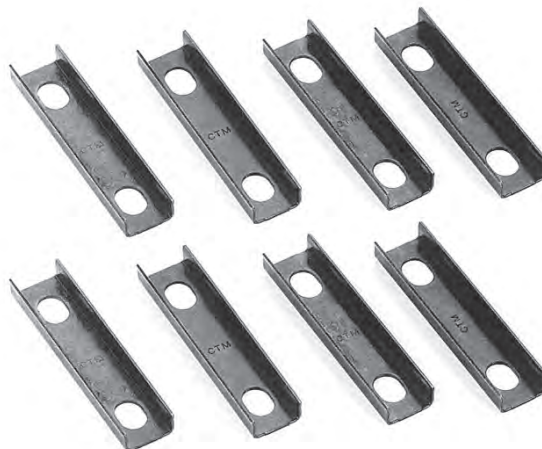

302 ONE PIECE REAR MAIN OIL SEAL M-6701-B302



- Direct replacement one-piece crankshaft rear main seal for 1983-2001 5.0L/302 blocks
- Also fits Ford Performance M-6010-BOSS302 and M-6010-B302BB block



351 W ONE-PIECE REAR MAIN OIL SEAL M-6701-B351



- High temperature resistant material
- Direct replacement one-piece crankshaft rear main seal for 351W from 7/11/83-1997
- Use on Ford Performance 351W blocks manufactured after 6/1/93
- Also fits Ford Performance M-6010-BOSS35192, M-6010-B35192BB, M-6010-BOSS35195 and M-6010-BOSS351BB block



PUSHROD ENGINES / COMPONENTS (CONTINUED)



CYLINDER HEAD GASKETS (SOLD IN PAIRS)

PART NUMBER	CYL. BORE APPLICATION	BORE DIA.	GASKET DIA.	COMPRESSED THICKNESS	COMPRESSED VOLUME	DESCRIPTION
M-6051-A302 ①	289/302/351W Production-type Cast Iron and Aluminum Heads	4.00"	4.100"	.042"	9.1 cc	4.00" standard bore "competition" gasket for cast iron or aluminum cylinder heads on 302 and 351W production blocks. Features solid metallic core with wire encased combustion chamber seal for applications. Surfaces are Teflon® coated.
M-6051-B341 ①	Big Bore 351 Ford Performance Blocks	4.125"	4.160"	.040"	9.1 cc	4.125" overbore "competition" gasket. Same as M-6051-D331 Gasket except designed for Ford Performance blocks with larger 4.125" overbore. Bore flange valve pockets have been added to unshroud intake and exhaust valves. Set includes unique right- and left-hand gaskets!
M-6051-A441 ①	429/460 Wedge	4.360"	4.500"	.0425"	11.2 cc	Race quality "competition" gasket. Features solid metal core and wire encased combustion chamber seal.
M-6051-C51 ①	302/351	4.00"	4.100"	.047"	10.169 cc	Fits pushrod 302 and 351 Ford high-performance engines.
M-6051-CP331 ①	302/351	4.00"	4.100"	.040"	8.8 cc	Pre-flattened copper wire combustion ring. Exhaust side is straight to accommodate FPP block water passages.
M-6051-D50 ①	302	4.100"	4.100"	.045"	9.7 cc	Includes 9 short head bolts, 10 long head bolts, 1 short head bolt with stud. Recommended for high-performance applications when using a stock block.
M-6051-R351 ①	302/351 Ford Performance	Up to 4.125"	4.160"	.040"	9.0 cc	For use on M-6010-R351/R352/R451/R452/BOSS302/B302BB/BOSS35195/BOSS35192/BOSS351BB.
M-6051-S331 ①	302/351	4.00"	4.100"	.040"	8.8 cc	Pre-flattened steel wire combustion ring. Exhaust side is straight to accommodate FPP block water passages.

① **NOTES:** Several different water hole patterns have been used on 302 and 351W Ford Performance cylinder blocks and heads since their introduction. Engine assemblers should lay the head gasket on the block and the cylinder head (with front of gasket toward the front of the engine) to make sure there is a path for coolant flow from the block into the head. In some cases, holes may have to be drilled in the block or head, or punched in the gasket.

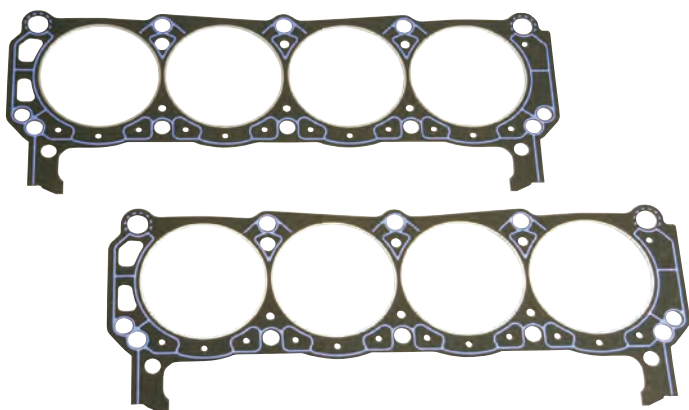

M-6051-A302

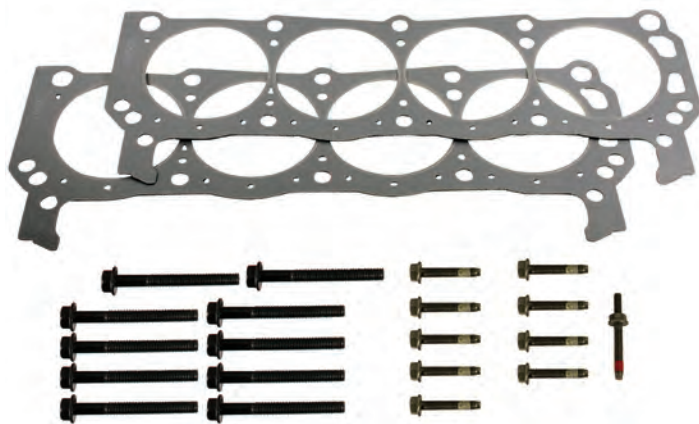

M-6051-D50

VALVE ROCKER ARM COVER GASKET (SOLD IN PAIRS)



PART NUMBER	APPLICATION	DESCRIPTION
M-6584-A50	289/302/351W M-6049-X306/ X307	Production-type design featuring metal gasket with bonded O-ring. Part of high-performance 5.0L M-6051-D50 Gasket Kit. Designed for valve covers without a gasket lip. (Does not fit M-6049-Z304DA Cylinder Heads and M-6582-BOSS/BOSSP/BOSS302/W427B/W427P valve covers. For these applications, Fel-Pro® VS 13264T recommended.)

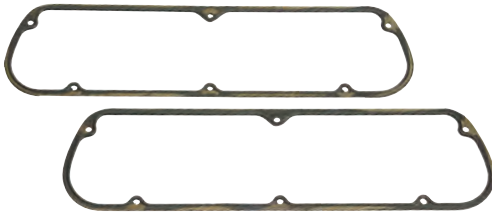

351W/5.8L ONE-PIECE RUBBER OIL PAN GASKET

M-6710-A351



- Fits 1969-1997 351W/5.8L
- Designed for use with smooth rail oil pans. Recommended for M-6675-DRS351, M-6675-FT351 and M-6675-A58
- One-piece design, rubber bonded on steel reinforcement



289/302 ONE-PIECE RUBBER OIL PAN GASKET

M-6710-A50



- Fits 1963-2001 289/302
- Designed for use with smooth rail oil pans. Recommended for M-6675-DRS302, M-6675-FT302 and M-6675-A50 oil pans
- One-piece design, rubber bonded on steel reinforcement



302/351W INTAKE MANIFOLD GASKET

M-9439-A50



- Fits Ford Performance small block "X" and "Z" aluminum cylinder heads except M-6049-Z304P. For intake gaskets for M-6049-Z304P, see M-9439-ZP
- Fits Ford Performance small block "N" cast iron cylinder heads
- Sold in engine set
- Synthetic rubber Print-O-Seal® (Fel-Pro® Inc.) bead around ports provides improved sealing
- Designed for improved port location and allows mild porting
- Non-stick coating, steel reinforced
- Gasket thickness 0.065"

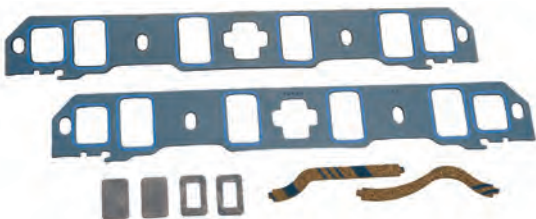

GRAPHITE INTAKE GASKET FOR STANDARD PORT 302/351W

M-9439-G50



- Graphite intake gasket for standard 302 and 351W intake port openings
- Fits all production heads with rectangle water openings and GT-40 cast iron heads



PORTED Z CYLINDER HEAD INTAKE MANIFOLD GASKET

M-9439-ZP

- Intake gasket is designed to fit Ford Performance ported 302-351 W high-flow "Z" M-6049-Z304P Cylinder Heads
- Fits most single plane intake manifolds, but needs to be checked for port alignment and for adequate sealing surface



EXHAUST MANIFOLD GASKETS (SOLD IN PAIRS)

PART NUMBER	CYLINDER HEAD APPLICATION
M-9448-B302	Production 289/302/351W



NOTE: Header flanges available from Hedman® headers. Contact local distributor.

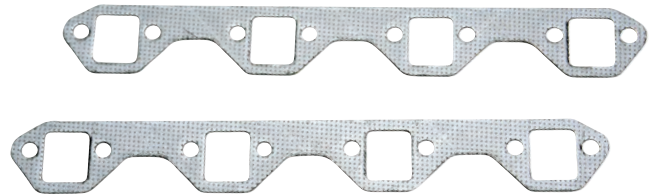

289/302 SINGLE PLANE "VICTOR JR." INTAKE MANIFOLD

M-9424-D302



- For use with 8.206" deck height block and inline valve heads
- 5.35" at the front of the carburetor pad, 5.42" at the rear
- Single plane Victor Jr.-style intake 3500-8000 rpm range
- For use with any high-rpm small block application

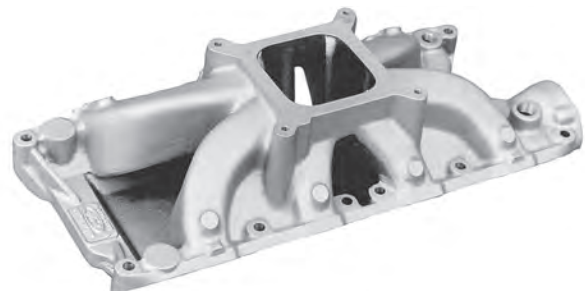

Call the Ford Performance Techline at (800)367-3788

PUSHROD ENGINES / COMPONENTS (CONTINUED)
289/302 DUAL PLANE INTAKE MANIFOLD
M-9424-F302

- For use with 8.206" deck height block and inline valve heads
- 4.375" at the front of the carburetor pad, 5.250" at the rear
- Dual plane intake
- 1500-6000 rpm range
- For use with any mid-rpm small block application, great for street cars and mild race engines
- Excellent fuel distribution
- Does not fit Z, Z2 or the GT-40 X heads

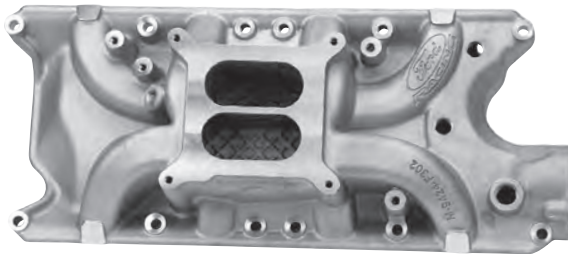
EFI UPPER-TO-LOWER INTAKE MANIFOLD GASKET
M-9486-A50

- Production-style GT-40 upper-to-lower intake gasket
- Sold in package of five

EFI HEAT SPACER .5" STOCK 5.0L INTAKE

CNC-machined from Westinghouse® Type C phenolic material. Fits between the upper and lower manifolds to help dissipate heat and significantly increase performance

M-9486-A51 .5" Stock 5.0L Intake

- Includes 4 each of a 2" long 5/16 x 18 bolt and flat washer, and 2 each of a 6-5/16" long 5/16 x 18 bolt and flat washer, for 1986-1993 5.0L intake.

M-9486-A52 .5" Cobra Intake

- Includes 2 each, 1-3/16" long 5/16 x 18 bolts, 5-7/16" long 5/16 x 18 bolts and 6" long 5/16 x 18 bolts, for Ford Performance Cobra intake manifold.

M-9486-A53 1" Cobra Intake

- Includes longer bolts for Ford Performance Cobra intake manifold. 4 each, 7-1/4" long 5/16 x 18 bolts, and 2 each, 2-3/4" long 5/16 x 18 bolts, with flat washers.

289/302/351W SHORT SERPENTINE BELT – FRONT TIMING CHAIN COVER
M-6059-A50

High quality die-cast aluminum timing chain cover

- For reverse rotation water pump
- Fits 289/302/351W blocks including Ford Performance BOSS 302 and Ford Performance BOSS 351
- Includes timing cover, timing cover gasket, and crankshaft seal
- Original equipment on 1994-1995 Mustang GT
- No fuel pump mounting boss or provision for dipstick assembly, must use electric fuel pump



289/302/351W FRONT TIMING CHAIN COVER
M-6059-D351

High quality die-cast aluminum production timing chain cover.

- Fits 289/302/351W blocks, including Ford Performance BOSS 302 and Ford Performance BOSS 351
- For standard rotation water pump, including M-8501-G351 or reverse rotation water pump M-8501-C50
- Includes dipstick tube hole for front sump oil pan and fuel pump mounting boss

302-351W STREET ROD SHORT V-BELT WATER PUMP
M-8501-E351S

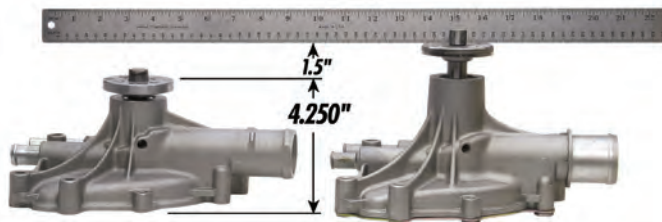
- Fits 302/351W engines
- Provides approx. 1.5" of space at the front of the engine, allowing for more radiator-to-water pump clearance without a recessed fire wall
- Driver-side (left hand) radiator hose inlet
- Must use with long style (3.950") 4-bolt crankshaft damper. Can be used with M-6316-M50 (50 oz-in) Crankshaft Damper or M-6316-A50 (50 oz-in), M-6316-C351 (28 oz-in) and M-6316-D351 (0 oz-in) crankshaft dampers with appropriate spacer
- .750" pulley pilot shaft
- Can be used with M-6059-D351 Timing Chain Cover or most stock standard rotation timing chain covers
- Requires custom pulleys (not included). Call the Ford PerformanceTechline for more information at (800)367-3788



302/351W MAXIMUM FLOW ALUMINUM WATER PUMP

M-8501-F351



- Standard rotation water pump for 1970-1978 5.0L and 1970-1987 351W engines
- Features premium quality aluminum casting, HD 3/4" ball/roller bearing, CNC-machined curved vane impeller and billet steel hub
- Driver-side water inlet
- Provides maximum flow, maximum pressure and equal distribution to both sides of the block



90 DEGREE THERMOSTAT HOUSING

M-8592-M90



- Fits 302/351W engines
- Die-cast aluminum 90° thermostat housing
- Radiator hose is 1-1/2" and bypass hose is 3/4"
- Used in Fox body Mustang 1979-1995
- Same as discontinued Ford Service Part No. FOZZ-8592-B



1994-1995 MUSTANG GT A/C ELIMINATOR KIT

M-19216-A50



- Fits 1994-1995 Mustang GT and 1991-1993 Thunderbird with 5.0L engine
- Cast aluminum idler pulley bracket replaces the air conditioning compressor
- Removes weight from the front of the car
- Bolts included
- Uses stock belt



1965-1969 MUSTANG BILLET SINGLE GROOVE PULLEY SET

M-8509-CM



- Fits 1965-1969 Mustang with 289/302/351W
- 3-bolt crank pulley
- Single-groove crank pulley
- Single-groove water pump pulley



1970-1978 MUSTANG BILLET SINGLE GROOVE PULLEY SET

M-8509-DM



- Fits 1970-1978 Mustang with 302/351W/351C
- 4-bolt crank pulley
- Single-groove crank pulley
- Single-groove water pump pulley



1970-1978 MUSTANG BILLET DUAL GROOVE PULLEY SET

M-8509-EM



- Fits 1970-1978 Mustang with 289/302/351W/351C
- 4-bolt crank pulley
- Dual-groove crank pulley
- Single-groove water pump pulley



HIGH TORQUE MINI STARTER – SMALL BLOCK

M-11000-B51



Fits most 289/302/351W/351C engines except 164-tooth manual transmission; for 164-tooth flywheel, see M-11000-MT164.

- Small diameter mini starter great for additional header clearance
- Weighs approximately 5 lbs less than pre-1989 production starters, yet provides more cranking power
- Comes with special battery cables and instructions. Must use diode protected fenderwell solenoid

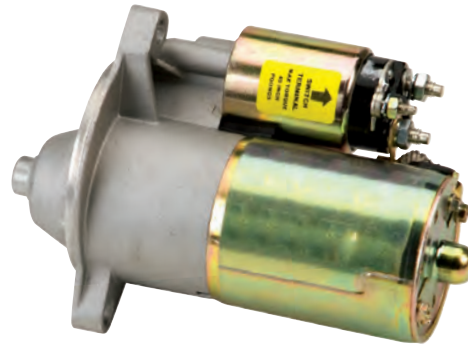

HIGH TORQUE MINI STARTER – SMALL BLOCK

M-11000-MT164



Fits most 289/302/351W/351C engines with 164-tooth manual transmission flywheel; for 157-tooth applications, see M-11000-B51.

- Small diameter mini starter great for additional header clearance
- Weighs approximately 5 lbs less than pre-1989 production starters, yet provides more cranking power
- Comes with special battery cables and instructions. Must use diode protected fenderwell solenoid



PUSHROD ENGINES / COMPONENTS (CONTINUED)

9 MM SPARK PLUG WIRE SETS – “FORD RACING”

Wire-wound custom ignition wire sets feature low resistance for minimum spark loss. Silicone insulation and boots withstand high temperatures and voltage loss for minimum cross-fire and are highly resistant to fuels, oils and solvents. Long-life, tough stainless steel terminals for post-type distributor caps. Includes coil wire for socket-type coil and “Ford Racing” identification. Cylinder number appears on each wire.

NEW AND IMPROVED. Spark plug wires feature high quality 9 mm wire available in 3 colors: blue, black and red.

PART NUMBER	APPLICATION	WIRE COLOR	END CONFIG.
M-12259-C301	5.0L/5.8L V8 Engine	Blue	45° Boot
M-12259-R301	5.0L/5.8L V8 Engine	Red	45° Boot
M-12259-M301	5.0L/5.8L V8 Engine	Black	45° Boot
M-12259-C302	V6 and V8 Universal	Blue	45° Boot
M-12259-M302	V6 and V8 Universal	Black	45° Boot

NOTES:

- Universal sets can be cut to length with a crimping tool. Includes terminals for post- and socket-type coils, plus easy-to-follow instructions.
- M-12259-C301/R301/M301/C302/M302 wire sets do not fit distributorless ignition system (DIS) 5.0L/302 Explorer engines. The universal wire sets do not fit distributorless ignition system (DIS).

⚠ WARNING: Cancer www.P65Warnings.ca.gov



M-12259-C301



M-12259-R301

1985-1993 MUSTANG 351W ENGINE SWAP ACCESSORY DRIVE KITS

- M-8511-A351 Power Steering Only
- M-8511-B351 Power Steering and A/C

- Fits 1985-1993 Mustang 351W
- These brackets allow use of your 5.0L front-end accessory drive components when swapping to a 351W (5.8L) engine. Simply replace production bracket with the new bracket using all existing bolts and hardware. Serpentine belt selection will vary, depending on whether or not you choose to use optional underdrive pulleys



M-8511-B351



M-8511-A351

⚠ WARNING: Cancer www.P65Warnings.ca.gov

1985-1993 MUSTANG A/C ELIMINATOR KIT M-8511-A50

- Fits 1985-1993 Mustang
- Bracket conversion kit to remove air conditioning compressor for racing applications
- Two-piece bracket kit moves the power steering pump up to where the A/C compressor was
- Hardware included
- Requires new belt (not included)

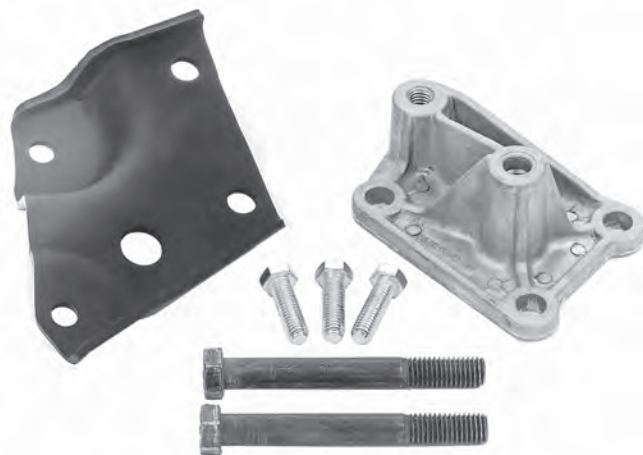

⚠ WARNING: Cancer www.P65Warnings.ca.gov

PUSHROD BIG BLOCK ENGINES AND COMPONENTS

572 CUBIC INCH 655 HP BIG BLOCK STREET CRATE ENGINE

M-6007-572DF* Front Sump Pan

M-6007-572DR* Rear Sump Pan

The BIG BLOCK is BACK!

This 572 cubic inch big block crate engine makes impressive power with excellent drivability while utilizing premium, unleaded pump gas.

- 655 horsepower @ 5500 rpm, 710 lb-ft torque @ 4500 rpm
- Engine type: 385 Series Big Block
- Displacement 572 cu in
- Bore x stroke 4.500" bore x 4.500" stroke
- Block: Ford Performance A460 big block M-6010-A460
- Crankshaft: SCAT® forged steel
- Connecting rods: SCAT® forged steel H-beam connecting rods and ARP® bolts
- Pistons: Diamond Racing® with floating wrist pins
- Camshaft:
 - Hydraulic roller
 - Lift: .649"
- Duration: Intake – 259° @ .050" lift, exhaust – 263° @ .050" lift
- Cylinder heads:
 - Ford Performance Super Cobra Jet aluminum cylinder heads M-6049-SCJA
 - Valve springs: Dual with damper
 - Intake valves: Stainless steel – 2.20" diameter
 - Exhaust valves: Stainless steel – 1.76" diameter
- Compression ratio: 10.0:1 (nominal)
- Required fuel: Premium unleaded
- Rocker arms: Crower® stainless steel roller rockers
- Timing chain: Ford Performance multi-index timing chain set M-6268-A460
- Oil pump: Heavy duty, aluminum body Jon Kaase® oil pump
- Vibration damper: Ford Performance SFI approved
- Balanced: Internally balanced – use neutral balanced flywheel (not included)

⚠ WARNING: Cancer www.P65Warnings.ca.gov

- Oil pan:
 - M-6007-572DF – Ford Performance M-6675-FT460 Front Sump Oil Pan
 - M-6007-572DR – Ford Performance M-6675-DRS460 Deep Rear Sump Oil Pan
- Intake manifold: Edelbrock® Victor® 2966
- Carburetor: Holley® Street Avenger 870 cfm
- Distributor: MSD® distributor
- Water pump: High-performance Edelbrock® water pump
- Spark plug wires: Ford Performance blue 9 mm spark plug wires M-12259-C460

Built with current available parts. Photo and specifications may vary.



M-6007-572DF shown

NEW 460 SIAMESE BIG BORE ENGINE BLOCK

M-6010-A460X Bore Range 4.360" - 4.600"

M-6010-A460XBB Bore Range 4.490" - 4.600"

- High-strength block for professional competition
- 10.322" deck height +/- .005"
- Cast iron block with 4-bolt main caps on journals 2, 3 and 4
- Nodular iron main caps
- 3.000" main journal diameter
- Siamese cylinder bore design
- Can be bored/stroked to produce 598 cu in
- Wet sump oiling design
- Priority main oiling system design
- Weighs approximately 275 lbs

NOTE: Siamese blocks are solid casting between the cylinder bores. There are no water passages between them. This is done to increase the strength of the block. 4-bolt main cap requires stock oil pan modifications.



PUSHROD BIG BLOCK ENGINES/COMPONENTS (CONT.)

PLUG AND DOWEL KIT

M-6026-A460

- Use with M-6010-A460 Cylinder Block
- Kit includes cam plug, oil gallery plugs, transmission dowels and head dowels



1979-1995 460 FOX ENGINE SWAP MOUNTS M-6038-A460

- Use in 1979-1995 Mustang and other Fox chassis cars to mount 429/460 engines
- Rubber insulated mount kit is designed to work with M-6675-A460 Rear Sump Oil Pan Kit and custom headers
- Does not fit I6 cylinder front crossmember



FORD PERFORMANCE 460 "SPORTSMAN" WEDGE-STYLE CYLINDER HEADS

M-6049-C460

- For use with Ford Performance M-6010-A460 Cylinder Block
- Used for professional competition and serious "Sportsman" racers
- Made from 356-T6 aluminum with bronze valve guides and a premium valve seat insert material compatible with titanium valves
- Valve angles are 7.5° intake, 8.0° exhaust with no side cant
- Raised intake and exhaust ports
- 65 cc wedge-style combustion chamber
- 4.600" recommended bore size (4.500" minimum)
- 2.450" intake, 1.900" exhaust recommended diameters
- Port and combustion chamber design based on Ford Performance 351 Yates® cylinder head



WARNING: Cancer www.P65Warnings.ca.gov

SUPER COBRA JET CYLINDER HEADS

M-6049-SCJ Bare Head
M-6049-SCJA Assembled With Dual Springs
M-6049-SCJB Assembled With Dual Springs w/Damper

- Fits 429 and 460 cu in engines (except BOSS 429)
- Valve angles and locations designed to reduce cylinder wall shrouding and improve flow
- Combustion chambers to accommodate the more centrally located valves
- Production 429 Cobra Jet intake and exhaust manifolds bolt on
- Production Ford 429/460 valve cover bolt pattern
- M-6582-C460 Ford Performance Valve Covers recommended
- 2.200" intake valve, 1.76" exhaust valve
- Flows approximately 330 cfm intake and 225 cfm exhaust
- 72 cc combustion chambers
- 290 cc intake runner, 148 cc exhaust runner
- M-6049-SCJA Heads: Assembled with hydraulic roller valve springs - closed seat pressure 135# @ 1.850"; Open seat pressure 365# @ 1.250"; Max lift .700"
- Machined 7-degree locks and steel valve spring retainers, premium valve seals
- M-6048-SCJB Heads: Assembled with solid roller springs - closed seat pressure 240# @ 1.900"; Open seat pressure 625# @ 1.200"; Max lift .650"
- Machined 10-degree locks and steel valve spring retainers, premium valve seals
- Uses M-6564-A460 Rocker Arm
- Uses Motorcraft AGSP series spark plugs

NOTE: If replacing Ford Performance or production 429 Cobra Jet heads, new intake valve notches are required.

NOTE: Uses Fel-Pro® exhaust gasket Part No. 1420 and Fel-Pro® intake gasket Part No. 1231.



HIGH-PERFORMANCE ENGINE GASKET SET

M-6003-A429



- Manufactured to Ford specs by Fel-Pro®
- The kit includes race-quality head gaskets and Print-O-Seal® intakes, oil pan and valve cover gaskets
- Includes front and rear oil seals plus all gaskets for a complete rebuild
- This high-performance gasket set is a must when rebuilding your Big Block Ford

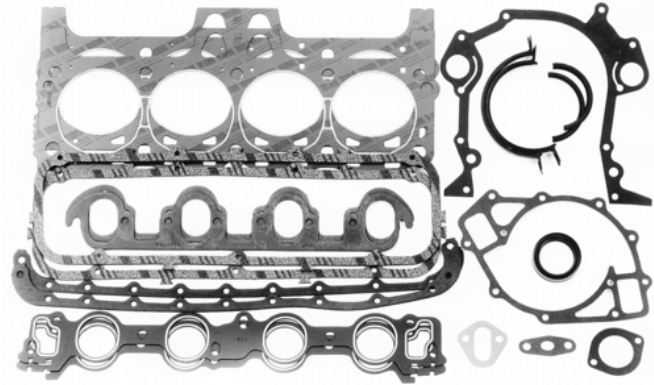

CYLINDER HEAD GASKETS (SOLD IN PAIRS)



PART NUMBER	CYLINDER BORE APPLICATION	BORE DIAMETER	GASKET DIAMETER	COMPRESSED THICKNESS	COMPRESSED VOLUME	NOTES
M-6051-A441	429/460 Wedge	4.360" Std.	4.500"	0.0425"	11.2 cc	Race-quality competition gasket. Features solid metal core and wire-encased combustion chamber seal
M-6051-B460	429/460 Wedge	Up to 4.625"	4.670"	0.038"	10.7 cc	Competition gasket with round water openings to match M-6010-A460 Engine Blocks



M-6051-A441



M-6051-B460

EXHAUST VALVE — SINGLE GROOVE (SOLD INDIVIDUALLY)

PART NUMBER	APPLICATION	HEAD DIAMETER	TIP LENGTH	TOTAL LENGTH	STEM DIAMETER	GROOVE TYPE	VALVE WEIGHT	DESCRIPTION
M-6505-A429	CJ/SCJ Aluminum M-6049-A429/B429/C429, M-6049-SCJ/SCJA/SCJB	1.760"	.250"	5.050"	11/32"	Square cut	122.1 grams	Premium stainless steel

INTAKE VALVE — SINGLE GROOVE (SOLD INDIVIDUALLY)

PART NUMBER	APPLICATION	HEAD DIAMETER	TIP LENGTH	TOTAL LENGTH	STEM DIAMETER	GROOVE TYPE	VALVE WEIGHT	DESCRIPTION
M-6507-B429	429/460 Wedge SCJ Aluminum M-6049-SCJ/ SCJA/SCJB	2.200"	.250"	5.265"	11/32"	Square cut	143.7 grams	Premium stainless steel



M-6505-A429



M-6507-B429

PUSHROD BIG BLOCK ENGINES/COMPONENTS (CONT.)

460/460 FORD PERFORMANCE SINGLE PLANE INTAKE MANIFOLD

M-9424-C460

- For use with 10.322" deck height block and M-6049-C460 "wedge" race heads
- 8.64" carburetor pad height
- High-rpm power
- For use on drag race engines

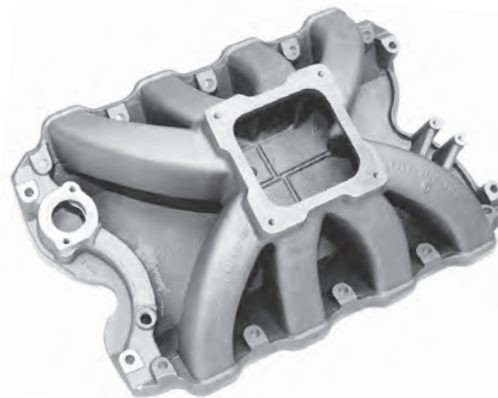

CAMSHAFT BEARINGS - ROLLER

(SOLD IN ENGINE SETS)

These low-friction, roller camshaft bearings only require oil "splash" lubrication. Oil feed holes can be totally blocked off to reduce oil aeration and windage losses. Engine block must be machined to accept bearing size shown in chart.



PART NUMBER	APPLICATION	O.D. DESCRIPTION	I.D. DESCRIPTION	LENGTH
M-6261-A460	429/460 Wedge	2.500"	2.125"	.625"

NOTE: The 429-460 dimensions are production. These roller bearings require an SAE 8620 steel camshaft.

390/427/428 DOUBLE ROLLER TIMING CHAIN SETS



- Full roller chain with 9-position multi-index crank sprocket. The crank sprocket has 2° increments for timing adjustment of up to 8° retarded, 8° advanced, or straight-up (no advance or retard)
- Chain is rugged, double-row type with oversized .250" rollers that deliver long life and reliability
- Crank sprocket is made from induction-hardened, billet steel

PART NUMBER	APPLICATION	DESCRIPTION
M-6268-A390	390/427/428 FE Engines	Cam sprocket is made from cast iron
M-6268-A460	429/BOSS 429/460	Recommended for competition engine builds. Requires steel thrust plate. M-6269-A460 Roller Bearing Thrust Plate recommended. Cam sprocket is made from steel. Compatible with single-piece fuel pump eccentric. Not for use with two-piece fuel pump eccentric
M-6268-B429	429/460	Cam sprocket is made from cast iron. Compatible with single-piece fuel pump eccentric. Not for use with two-piece fuel pump eccentric



Left to right: M-6268-A390, M-6268-A460, M-6268-B429

CRANKSHAFT DAMPER



- Ford Performance crankshaft dampers are used on most Ford Performance push rod crate engines
- Billet steel construction, meets SFI 18-1 requirements
- Elastomer-style harmonic vibration damper
- Laser-etched timing marks and "Ford Racing" logo
- 3- and 4-bolt pulley mounting holes
- Clear powdercoat finish



PART NUMBER	ENGINE	BALANCE	NOTES	MASS (LBS)
M-6316-A460	429/460	Neutral	Meets SFI 18-1	10.1
M-6316-A521	514/521	Neutral	Meets SFI 18-1 ①	10.1

NOTE: ① Tuned for use on 521 crate engine.

460/514 CRANKSHAFT DAMPER SPACER M-6359-D460



- Spacer with counterweight for 1979-1997 external balanced 460 engines
- Same as discontinued production service part D9TZ-6359-A



429/460 OIL PUMP DRIVESHAFT M-6605-A429



- Fits 429/460/BOSS 429 and Ford Performance A460 blocks
- Heavy duty
- Heat treated chrome moly steel
- Centerless ground



429/460 HIGH VOLUME OIL PUMP M-6600-A460



- Fits 1968-1996 429/460
- High volume – standard pressure
- Requires bolt-on style pickup (not included)
- Does not fit 429 Cobra Jet oil pump pickup tube
- Recommended with M-6675-DRS460 and M-6675-FT460 oil pans
- Due to the higher pumping capacity of this pump, it is not recommended for use with a stock capacity oil pan



HIGH-CAPACITY PERFORMANCE OIL PANS

REAR SUMP

460 DEEP REAR SUMP OIL PICKUP TUBE M-6622-DRS460

- Use with M-6675-DRS460 460 Deep Rear Sump Oil Pan
- Quality built-in precision fixtures for a consistent OEM-level fit
- High-flow funnel-style pickup same as used on Mustang Cobra 4.6L 4V engines
- Thin wire screen delivers more than twice the flow area compared to many aftermarket pickup screens
- Thin wall 3/4" diameter tubing reduces vibration fatigue



460 DEEP REAR SUMP OIL PAN M-6675-DRS460



Designed by Ford Performance, the M-6675-DRS460 Oil Pan is constructed to deliver power and durability.

- Fits 429/460 and Ford Performance M-6010-A460X and M-6010-A460XBB blocks
- 7 qt capacity
- Full-length scraper to direct oil away from the crankshaft
- Full-length bolt-in louvered windage tray to control oil
- Baffling and trap doors in the sump to keep the pickup submerged during performance driving
- Semigloss black powdercoat finish
- Laser-cut and TIG welded-in precision fixtures for consistent OEM-level fit
- Use M-6622-DRS460 Pickup. Requires rear sump truck oil pump
- Accepts STD and HV oil pumps



FRONT SUMP

460 FRONT SUMP OIL PAN PICKUP TUBE M-6622-FT460

- Use with M-6675-FT460 Front Sump Oil Pan
- Quality built-in precision fixtures for a consistent OEM-level fit
- High-flow funnel-style pickup same as used on Mustang Cobra 4.6L 4V engines
- Thin wire screen delivers more than twice the flow area compared to many aftermarket pickup screens
- Thin wall 3/4" diameter tubing reduces vibration fatigue



460 FRONT SUMP OIL PAN M-6675-FT460



Designed by Ford Performance, the M-6675-FT460 Oil Pan is constructed to deliver power and durability.

- Fits 429/460 and Ford Performance M-6010-A460, M-6010-A460X and M-6010-A460XBB blocks
- 7 qt capacity
- Full-length scraper to direct oil away from the crankshaft
- Full-length bolt-in louvered windage tray to control oil
- Baffling and trap doors in the sump to keep the pickup submerged during performance driving
- Semigloss black powdercoat finish
- Laser-cut and TIG welded-in precision fixtures for consistent OEM-level fit
- Use M-6622-FT460 Pickup
- Accepts STD and HV oil pumps



PUSHROD BIG BLOCK ENGINES/COMPONENTS (CONT.)

9 MM SPARK PLUG WIRE SETS – “FORD RACING”

Wire-wound custom ignition wire sets feature low resistance for minimum spark loss. Silicone insulation and boots withstand high temperatures and voltage loss for minimum crossfire and are highly resistant to fuels, oils and solvents. Long-life, tough stainless steel terminals for “post” type distributor caps. Includes coil wire for socket-type coil and “Ford Racing” identification. Cylinder number appears on each wire.

Spark plug wires feature high-quality 9 mm wire.

PART NUMBER	APPLICATION	WIRE COLOR	END CONFIG.
M-12259-C460	7.0L/7.5L V8 Engine	Blue	45° Boot
M-12259-R460	7.0L/7.5L V8 Engine	Red	45° Boot



M-12259-C460



M-12259-R460

WARNING: Cancer www.P65Warnings.ca.gov

460 BIG BLOCK TIMING COVER
M-6059-460

- Fits 460 and 514 Ford Performance big blocks
- Cast aluminum construction with black finish
- Does not have provisions for dipstick in timing cover or mechanical fuel pump
- Oil pan to timing cover bolt holes 1/4-20
- Includes M-8501-460BP Big Block Water Pump Backing Plate



460 ENGINE SWAP OIL PAN KIT
M-6675-A460



- 429/460/7.5L oil pan kit
- Includes rear sump oil pan, dipstick, dipstick tube, pickup and main cap stud
- Ideal for engine swaps
- Fits 1979-1995 Mustang and Fox chassis vehicles
- Fits 1968-1997 production blocks
- **Rear sump oil pump required, not included.** Fasteners not included.



NOTE: Some block/timing cover applications may require 5/16" to 1/4" conversion studs. Not recommended for M-6010-A460 Race Block.

429/460 ONE-PIECE RUBBER OIL PAN GASKET
M-6710-A460



- Fits 1968-1997 429/460
- Designed for use with smooth rail oil pans. Recommended for M-6675-DRS460, M-6675-FT460 and M-6675-A460
- One-piece design, rubber bonded on steel reinforcement

NOTE: Some block/timing cover applications may require 5/16" to 1/4" conversion studs.



460 BIG BLOCK WATER PUMP BACKING PLATE
M-8501-460BP



- Great replacement backing plate for hard-to-find OEM plate
- Made from steel material
- Fits M-8501-C460 Water Pump and production water pumps



PUSHROD I-4 ENGINES AND COMPONENTS

1.6 LITER 4-CYLINDER KENT BLOCK M-6010-16K



The legendary Formula Ford Kent block is reborn with a new iron casting that is stronger than the original!

The block was designed to replace production 1.6L Kent blocks for SCCA® Formula Ford competition.

- Standard 8.200" deck height with extra material for decking
- Cylinder bores semifinished to 3.185"-3.187" diameter to allow the engine to be built to desired clearances
- Max bore size is 3.226" (81.94 mm)
- Lifter bore diameter: .5155"-.5145"
- Block cast from 40,000 psi gray iron
- Lower clutch housing bolt bosses reinforced
- Select areas around main bearing webs strengthened
- Center main will accept upper and lower crankshaft thrust bearing inserts
- Includes cam bearings (installed)



M-6010-16K shown

1.6 LITER 4-CYLINDER LOTUS BLOCK M-6010-16L



The Lotus block features an a new gray iron casting that is stronger than the original and accepts the Lotus cylinder head.

- Standard 7.800" deck height with extra material for decking
- Machined and delivered with cylinder bores semifinished at 3.228"-3.226" (81.99 mm-81.94 mm) diameters
- Block is designed for standard bore engine builds
- Lifter bore diameter: .5155"-.5145"
- Block cast from 40,000 psi gray iron
- Lower clutch housing bolt bosses reinforced
- Select areas around main bearing webs strengthened
- Center main will accept upper and lower crankshaft thrust bearing inserts
- Includes cam bearings (installed)

4-CYLINDER KENT VALVE COVER M-6582-16K

- Fits 1.6L Kent cylinder head
- Cast aluminum construction



NASCAR® ENGINES

FR9 NASCAR® ENGINE BLOCK M-6010-R500

Features:

- Lightweight compacted graphite iron casting
- Cross-flow cooling
- Cast-in camshaft tunnel
- Inner and outer piston squirter provisions
- Front engine plate mounting (no side mounts)
- Dry sump only design
- 4-bolt steel main caps
- Internal oil passages to the cylinder heads

Specifications:

- Deck height: 9.000"
- Bore spacing: 4.500"
- Camshaft height: 6.150"
- Bore size range: 4.000"-4.185"
- Main journal diameter: 2.250"
- Cam bearing diameter: 60 mm roller

Required Components:

- M-6049-E1 Cylinder Head
- M-8C368-FR9 Water Manifold
- M-8051-FR9 Water Pump Assembly

Recommended Use:

- Approved for the NASCAR® Cup Series
- Circle track competition



Builder Notes:

- Semifinished cylinder bores, main bearing bores and lifter bores – must be honed to final size
- The FR9 engine is unique and does not share any components with previous 351 Windsor- or Cleveland-based engines
- For FR9 engine-related components not offered by Ford Performance, contact Roush Yates® Performance Parts at (704)662-6982

FR9 NASCAR® CYLINDER HEAD M-6049-E1

Fits M-6010-R500 NASCAR® Cylinder Block

Features:

- Lightweight A356-T6 aluminum casting
- Cross-flow cooling
- Internal oil passages for valvetrain lubrication
- Splayed and canted intake valves
- 5-bolt head bolt pattern

Specifications:

- Intake valve angle: 11.0° x 4.0°
- Exhaust valve angle: 7.5° x 0°
- Valve spacing: 1.94"
- Intake flange angle: 90°
- Exhaust flange angle: 60°

Required Components:

- M-6010-R500 Cylinder Block
- M-8C368-FR9 Water Manifold

Recommended Use:

- Approved for the NASCAR® Cup and Xfinity® Series
- Circle track competition

Builder Notes:

- Heads are semifinished, requiring porting and combustion chamber machining
- Valve guides and seats are not included
- M-8C368-FR9 Water Manifold mounts directly to the cylinder heads
- The FR9 engine is unique and does not share any components with previous 351 Windsor- or Cleveland-based engines
- For FR9 engine-related components, contact Roush Yates® Performance Parts at (704)662-6982

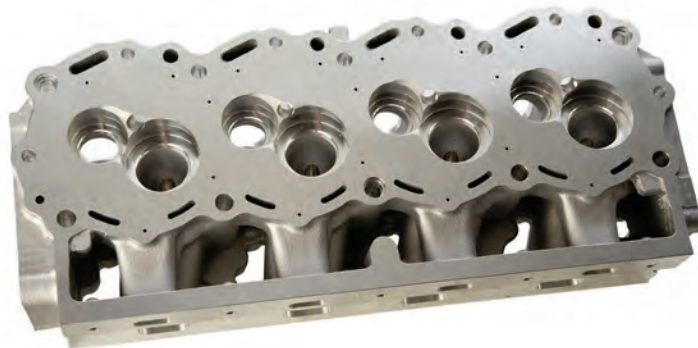
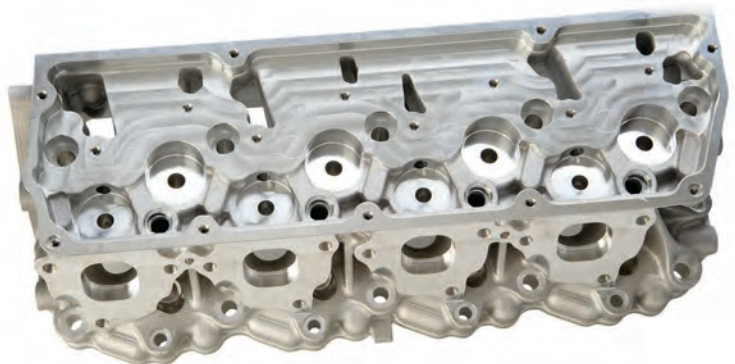

⚠ WARNING: Cancer www.P65Warnings.ca.gov

FR9 WATER PUMP ASSEMBLY M-8501-FR9



Features:

- Includes water pump and housing
- Lightweight aluminum castings
- EMP Stewart Components® race-proven pump cartridge
- Designed to mount to front engine plate

Recommended Use:

- Circle track competition

Builder Notes:

- The FR9 engine is unique and does not share any components with previous 351 Windsor- or Cleveland-based engines

FR9 WATER OUTLET MANIFOLD M-8C368-FR9



Features:

- Lightweight aluminum casting
- Straight outlet to accommodate LH or RH radiator water inlet
- Provision for water temperature sensor
- For use with M-6049-E1 Heads

Recommended Use:

- Circle track competition

Builder Notes:

- O-ring sealing provisions are machined into M-6049-E1 Cylinder Head
- The FR9 engine is unique and does not share any components with previous 351 Windsor- or Cleveland-based engines
- For FR9 engine-related components, contact Roush Yates® Performance Parts at (704)662-6982



NASCAR® INTAKE MANIFOLDS

Features:

- For use with M-6049-E1 Heads
- A356-T6 aluminum casting
- Plenum and runner interiors are as-cast
- Intended operating range is 6000 rpm-9500 rpm
- Approved for NASCAR® restrictor plate and open Cup events

Required Components:

- M-6049-E1 Cylinder Head

Builder Notes:

- Intake manifold plenum and runners require porting before use
- The FR9 engine is unique and does not share any components with previous 351 Windsor- or Cleveland-based engines



FR9 INTAKE MANIFOLD – FUEL INJECTION M-9424-E554



- For use with NASCAR® mandated fuel-injection system
- Casting features bosses to accommodate fuel injector and fuel rail machining
- Approved for NASCAR® Cup Series

FR9 INTAKE MANIFOLD M-9424-E651



- For use with a carburetor
- Approved for NASCAR® Xfinity® and Truck Series

ENGINE / BLOCK SPECIFICATIONS AND DIMENSIONS

CYLINDER BLOCKS

ENGINE GROUP	302 FORD	302 FORD	351 FORD	351 FORD	351 FORD	351 FORD
PART NUMBER	M-6010-BOSS302	M-6010-B302BB	M-6010-BOSS35192	M-6010-BOSS35192BB	M-6010-BOSS35195	M-6010-BOSS351BB
Description/Intended Usage	Professional Competition	Professional Competition	Professional Competition	Professional Competition	Professional Competition	Professional Competition
Block Material	Cast Iron	Cast Iron	Cast Iron	Cast Iron	Cast Iron	Cast Iron
Nominal Deck Height	8.206"	8.206"	9.200"	9.200"	9.500"	9.500"
CID Capacity	363	363	427	427	454	468
Cylinder Design	Siamese	Siamese	Siamese	Siamese	Siamese	Siamese
Cylinder Bore Range	4.000"-4.125"	4.000"-4.125"	4.000"-4.125"	4.000"-4.125"	4.000"-4.125"	4.000"-4.185"
Oil Sump Design	Wet	Wet	Wet	Wet	Wet	Wet
Crankshaft Journal Diameter	2.248"	2.248"	2.750"	2.750"	2.750"	2.750"
Main Cap Bolts	Four on 2,3,4	Four on 2,3,4	Four on 2,3,4	Four on 2,3,4	Four on 2,3,4	Four on 2,3,4
Bearing Cap Material	Nodular Iron	Nodular Iron	Nodular Iron	Nodular Iron	Nodular Iron	Nodular Iron
Recommended Max. Stroke	3.400"	3.400"	4.000"	4.000"	4.250"	4.250"
Rear Crankshaft Seal Type	1-Piece	1-Piece	1-Piece	1-Piece	1-Piece	1-Piece
Cam Bearing Design	M-6261-J351 Standard Cam	M-6261-J351 Standard Cam	M-6261-J351 Standard Cam	M-6261-J351 Standard Cam	M-6261-J351 Standard Cam	M-6261-J351 Standard Cam
Oil Filter Mount	Block	Block	Block	Block	Block	Block
Hyd. Roller Cam. Compatible	Yes	Yes	Yes	Yes	Yes	Yes
Cam Plug	M-6026-S351	M-6026-S351	M-6026-S351	M-6026-S351	M-6026-S351	M-6026-S351

CYLINDER BLOCKS

ENGINE GROUP	351 FORD	351 FORD	460 FORD	460 FORD	NASCAR® FORD
PART NUMBER	M-6010-Z351	M-6010-Z35192	M-6010-A460X	M-6010-A460XBB	M-6010-R500
Description/Intended Usage	Professional Competition	Professional Competition	Professional Competition	Professional Competition	Professional Competition
Block Material	Aluminum	Aluminum	Cast Iron	Cast Iron	Compacted Graphite Iron
Nominal Deck Height	9.500"	9.200"	10.322"	10.322"	9.000"
CID Capacity	434	427	598	598	-
Cylinder Design	Siamese	Siamese	Siamese	Siamese	Non-Siamese
Cylinder Bore Range	4.000"-4.125"	4.000"-4.125"	4.360"-4.600"	4.500"-4.600"	4.000"-4.185"
Oil Sump Design	Wet	Wet	Wet	Wet	Dry
Crankshaft Journal Diameter	2.750"	2.750"	3.000"	3.000"	2.000"-2.250"
Main Cap Bolts	Four	Four	Four on 2,3,4,5	Four on 2,3,4,5	Four
Bearing Cap Material	Steel	Steel	Nodular Iron	Nodular Iron	Steel
Recommended Max. Stroke	4.250"	4.250"	4.500"	4.500"	-
Rear Crankshaft Seal Type	1-Piece	1-Piece	2-Piece	2-Piece	1-Piece
Cam Bearing Design	M-6261-J351 Standard Cam	M-6261-J351 Standard Cam	Std.	Std.	Roller
Oil Filter Mount	Block	Block	Block	Block	Remote
Hyd. Roller Cam. Compatible	-	-	-	-	-
Cam Plug	M-6026-S351	-	-	-	-

PUSHROD CRATE ENGINES AND SHORT BLOCKS

PART NUMBER	M-6007-X2302E	M-6007-X2347DF M-6007-X2347DR	M-6009-347	M-6009-363	M-6009-460
Displacement (cu in)	302	347	347	363	460
Horsepower (hp) Racer Correction (SAE J607)	340	N/A	N/A	N/A	N/A
Torque (lb-ft) Racer Correction (SAE J607)	350	N/A	N/A	N/A	N/A
Compression Ratio	9.0:1	9.6:1	N/A	N/A	N/A
Cylinder Heads	M-6049-X306	M-6049-X306	N/A	N/A	N/A
Camshaft	E303 hydraulic roller	Hydraulic roller	N/A	N/A	N/A
Crankshaft	3.000" forged	3.400" forged	3.400" forged	3.400" forged	4.25" forged
Piston	4.030" forged	4.030" Mahle® forged Grafal® coated skirt	4.030" Mahle® forged Grafal® coated skirt	4.125" Mahle® forged	4.150 Mahle® forged
Connecting Rod	Forged I-beam 5.090"	Forged I-beam 5.400"	Forged I-beam 5.400"	Forged I-beam 5.400"	Forged H-beam 6.125"
Valve Cover	M-6582-W351PR	M-6582-A301R Ford Racing Aluminum	N/A	N/A	N/A
Oil Pan	Rear sump	7 qt front sump/ 7 qt rear sump	N/A	N/A	N/A
Water Pump	N/A	None	N/A	N/A	N/A
Block	M-6010-BOSS302	M-6010-BOSS302	M-6010-BOSS302	M-6010-BOSS302	M-6010-BOSS35195

PUSHROD CRATE ENGINES AND SHORT BLOCKS

PART NUMBER	M-6007-Z2363FT M-6007-Z2363RT	M-6007-S347JR2	M-6007-D347SR M-6007-D347SR7	M-6009-427F	M-6007-Z2427FFT M-6007-Z2427FRT	M-6007-Z460FFT M-6007-Z460FRT
Displacement (cu in)	363	347	347	427	427	460
Horsepower (hp) Racer Correction (SAE J607)	500	350	415	N/A	535	580
Torque (lb-ft) Racer Correction (SAE J607)	450	400	400	N/A	545	580
Compression Ratio	10.2:1	10.5:1	10.0:1	N/A	10.5:1	10.0:1
Cylinder Heads	M-6049-Z2	M-6049-X307	M-6049-Z304DA	N/A	M-6049-Z2	M-6049-Z304DA
Camshaft	Hydraulic roller	Hydraulic roller	F303 hydraulic roller	N/A	Hydraulic roller	Hydraulic roller
Crankshaft	3.400" forged	3.400" forged	3.400" forged	4.000" forged	4.000" forged	4.150" forged
Piston	4.125" Mahle® forged Grafal® coated skirt	4.030" Mahle® forged Grafal® coated skirt	4.030" Mahle® forged Grafal® coated skirt	4.125" Mahle® forged Grafal® coated skirt	4.125" Mahle® forged Grafal® coated skirt	4.250" Mahle® forged Grafal® coated skirt
Connecting Rod	Forged I-beam 5.400"	Forged I-beam 5.400"	Forged I-beam 5.400"	Forged H-beam 6.250"	Forged H-beam 6.250"	Forged H-beam 6.125"
Intake	N/A	RPM Air-Gap 302	Victor Jr.®	N/A	N/A	N/A
Distributor	N/A	MSD® Billet Distributor	MSD® Billet Distributor	N/A	N/A	N/A
Valve Cover	Ford Racing 302-139	M-6582-CT2	M-6582-CT2	N/A	Ford Racing 302-135	Ford Racing 302-137
Oil Pan	7 qt front sump/ 7 qt rear sump	7 qt rear sump	7 qt rear sump	N/A	9 qt front sump/ 7 qt rear sump	9 qt front sump/ 7 qt rear sump
Water Pump	V-belt	V-belt	V-belt	N/A	V-belt	V-belt
Block	M-6010-BOSS302	M-6010-BOSS302	M-6010-BOSS302	M-6010-BOSS35195	M-6010-BOSS35195	M-6010-BOSS35195

ENGINE/BLOCK SPECS AND DIMENSIONS (CONTINUED)
MODULAR CRATE ENGINES AND SHORT BLOCKS

PART NUMBER	M-6007-M50C M-6007-M50A	M-6007-M50CAUTO M-6007-M50AUTO	M-6007-A50NAB M-6007-A50NAA	M-6007-A50SCB M-6007-A50SCA	M-6007-A52XS
Displacement	5.0L	5.0L	5.0L	5.0L	5.2L
Horsepower (hp)	460 – M50C 435 – M50A	460 – M50CAUTO 435 – M50AUTO	460 – A50NAB 435 – A50NAA	N/A	580
Torque (lb-ft)	420 – M50C 400 – M50A	420 – M50C 400 – M50A	420 – M50NAB 400 – M50NAA	N/A	445
Compression Ratio	12.0:1 – M50C 11.0:1 – M50A	12.0:1 – M50CAUTO 11.0:1 – M50AUTO	12.0:1 – A50NAB 11.0:1 – A50NAA	9.5:1	12.0:1
Combustion Chamber Volume (cc)	56	56	56	56	55.6
Cylinder Heads	Production	Production	Production	Production	GT350 CNC-ported
Camshafts	Production	Production	Production	Production	M-6550-M52
Crankshaft	Forged steel	Forged steel	Forged steel	Forged steel	Forged steel
Connecting Rod	Forged steel	Forged steel	Manley® H-beam	Manley® H-beam	Manley® H-beam
Piston	Cast, hard-anodized ring grooves Grafal® coated skirts	Cast, hard-anodized ring grooves Grafal® coated skirts	Mahle® forged hard-anodized ring grooves Grafal® coated skirts	Mahle® forged hard-anodized ring grooves Grafal® coated skirts	Mahle® forged hard-anodized ring grooves Grafal® coated skirts
Intake Manifold	M50C – 2018 Mustang M50A – 2015 Mustang	M50CAUTO – 2018 Mustang M50AUTO – 2015 Mustang	A50NAB – 2018 Mustang A50NAA – 2015 Mustang	A50SCB – 2018 Mustang A50SCA – 2015 Mustang	M-9424-M50CJ Cobra Jet tuned intake
Ignition	Coil on plug	Coil on plug	Coil on plug	Coil on plug	Coil on plug
Valve Covers	Production	Production	Production	Production	Exclusive
Oil Pan	Production	Production	Production	Production	M-6675-M52
Water Pump	Production	Production	Production	Production	Production
Block	Production Mustang GT 5.0L	Production Mustang GT 5.0L	Production Mustang GT 5.0L	Production Mustang GT 5.0L	M-6010-M52B

MODULAR CRATE ENGINES AND SHORT BLOCKS

PART NUMBER	M-6009-A50NAB M-6009-A50NAA	M-6009-A50SCB M-6009-A50SCA	M-6009-B53
Displacement	5.0L	5.0L	5.3L
Horsepower (hp)	N/A	N/A	N/A
Torque (lb-ft)	N/A	N/A	N/A
Compression Ratio	N/A	N/A	11.56:1 (44 cc chamber) (2VPI) 10.50:1 (51 cc chamber) (3V) 10.23:1 (53 cc chamber) (4V)
Combustion Chamber Volume (cc)	N/A	N/A	N/A
Cylinder Heads	N/A	N/A	N/A
Camshafts	N/A	N/A	N/A
Crankshaft	Forged steel	Forged steel	Forged Eagle® 8-bolt steel
Connecting Rod	Manley® Forged H-beam	Manley® Forged H-beam	Eagle® forged H-beam
Piston	Mahle® forged hard-anodized ring grooves Grafal® coated skirts	Mahle® forged hard-anodized ring grooves Grafal® coated skirts	Mahle® forged hard-anodized ring grooves Grafal® coated skirts
Intake Manifold	N/A	N/A	N/A
Ignition	N/A	N/A	N/A
Valve Covers	N/A	N/A	N/A
Oil Pan	N/A	N/A	N/A
Water Pump	N/A	N/A	N/A
Block	Production Mustang GT 5.0	Production Mustang GT 5.0	M-6010-BOSS50

BASIC ENGINE DIMENSIONS (INCHES) – GASOLINE ENGINES

DISPLACEMENT	YEARS	BORE	STROKE	BORE SPACING	MAIN JOURNAL DIA.	ROD JOURNAL DIA.	CON ROD LENGTH (MEAN)	DECK HEIGHT	PISTON COMP HT
1.6L Kent	1971-73	3.188	3.056	3.780	2.1253	1.9372	4.928	8.2272	—
1.6L CVH	1981-85	3.150	3.130	3.614	2.383	1.886	5.195	8.212	1.451
1.9L CVH	1985-87	3.230	3.465	3.614	2.383	1.886	5.195	8.378	1.451
1.9L CVH	1988-96	3.230	3.465	3.614	2.383	1.728	5.195	8.378	1.451
1.8L ZETEC® DOHC	1991-96	3.270	3.350	3.583	1.966	1.771	5.230	8.130	1.108
2.0L I4 Duratec®	2005-TBD	3.445	3.272	3.780	2.047	1.850	5.758	8.540	1.122
2.0L CVH	1997-98	3.339	3.465	3.614	2.383	1.728	5.195	8.378	1.451
2.0L OHC ¹	1971-74	3.575	3.029	4.016	2.244	2.047	4.982	8.146	1.595 ⁵
2.0L OHC ²	1983-87	3.520	3.126	4.173	2.399	2.047	5.205	8.368	1.583
2.0L ZETEC®	1995-04	3.339	3.465	3.614	2.283	1.847	5.3618 ⁶	8.378	1.3012 ⁷
2.0L V6	2001-04	3.215	2.631	4.016	2.479	1.967	5.686	8.189	1.181
2.2L Probe	1988-92	3.390	3.700	3.810	2.360	2.006	6.200	9.500	1.450
2.3L I4 Duratec®	2001-07	3.445	3.701	3.780	2.047	1.968	6.094	9.094	1.122
2.3L OHC	1974-97	3.780	3.126	4.173	2.399	2.047	5.205	8.368	1.583
2.5L OHC	1998	3.780	3.401	4.173	2.399	2.047	5.457	8.368	1.211
2.3L HSC	1984-94	3.680	3.300	4.080	2.249	2.124	5.457	8.700	1.520
2.3L EcoBoost®	2015-2019	3.445	3.701	3.780	2.047	2.167	5.879	9.094	1.291
2.5L HSC	1986-91	3.680	3.583	4.080	2.249	2.124	5.990	9.400	1.579
2.5L V6 Duratec®	1995-99	3.245	3.130	4.016	2.480	1.968	5.437	8.189	1.181
2.5L V6 Duratec®	1999-07	3.215	3.130	4.016	2.480	1.968	5.437	8.189	1.181
2.6L V6	1972-73	3.545	2.630	4.760	2.244	2.127	—	8.084	1.546
2.7L V6 EcoBoost®	2015-2019	3.268	3.268	3.740	2.657	2.340	5.747	8.594	1.201
2.8L V6	1974-80	3.650	2.700	4.760	2.244	2.127	5.140	8.084	1.539
2.9L V6	1986-92	3.661	2.835	4.760	2.244	2.126	5.140	8.858	1.461
3.0L V6	1986-07	3.504	3.150	4.330	2.519	2.126	5.532	8.661	1.535
3.0L V6 Duratec®	1997-07	3.504	3.130	4.016	2.480	1.968	5.437	8.189	1.181
3.5L V6 Duratec®	2006-07	3.642	3.413	4.173	2.658	2.205	6.011	8.970	1.240
3.0L V6 SHO	1989-95	3.500	3.150	4.330	2.516	2.047	5.780	8.660	1.307
3.2L V6 SHO	1993-95	3.620	3.150	4.330	2.516	2.047	5.780	8.660	1.307
3.4L V8 SHO	1996	3.245	3.130	4.016	2.480	1.968	5.437	8.189	1.181
3.5L V6 EcoBoost®	2011-2019	3.641	3.413	4.173	2.657	2.204	6.01	8.970	1.240
3.7L V6	2011-2017	3.759	3.413	4.173	2.657	2.204	6.01	8.970	1.240
3.8L V6	1982-95	3.810	3.390	4.193	2.5194 ⁴	2.311	5.914	9.232	1.602
3.8L V6	1997-03	3.810	3.390	4.193	2.519	2.311	6.091	9.232	1.450
3.9L V6	2004-07	3.810	3.465	4.193	2.519	2.311	6.091	9.232	1.411
3.9L V8 ⁸	2000-02	3.386	3.346	3.858	2.441	2.205	6.115	8.880	1.211
3.9L V8 ⁸	2002-07	3.386	3.346	3.858	2.441	2.087	6.115	8.880	1.211
4.0L V6	1990-00	3.950	3.320	4.760	2.244	2.126	5.748	8.858	1.442
4.0L V6	1997-07	3.950	3.320	4.760	2.244	2.126	5.748	8.858	1.440
4.2L V6	1997-07	3.810	3.740	4.193	2.519	2.311	6.091	9.232	1.273
4.5L Ford Performance	³	4.080	3.500	4.469	2.749	2.100	6.088	9.232	³
4.6L V8	1991-07	3.552	3.543	3.937	2.657	2.086	5.933	8.937	1.221
5.0L V8	2018-19	3.661	3.647	3.937	2.657	2.086	5.933	8.937	1.221
5.0L V8	2011-17	3.629	3.647	3.937	2.652	2.082	5.933	8.937	1.220
5.2L V8	2015-19	3.701	3.661	3.937	2.657	2.086	5.93	8.937	1.161
5.4L V8	1997-07	3.552	4.165	3.937	2.657	2.086	6.658	10.079	1.167

ENGINE/BLOCK SPECS AND DIMENSIONS (CONTINUED)
BASIC ENGINE DIMENSIONS (INCHES) – GASOLINE ENGINES (CONTINUED)

DISPLACEMENT	YEARS	BORE	STROKE	BORE SPACING	MAIN JOURNAL DIA.	ROD JOURNAL DIA.	CON ROD LENGTH (MEAN)	DECK HEIGHT	PISTON COMP HT
5.8L V8	2013-2014	3.681	4.230	3.937	2.6567-2.6577	2.0867-2.0859	6.6575	10.0673	1.2185-1.2224
6.8L V10	1997-07	3.552	4.165	3.937	2.657	2.086	6.657	10.079	1.221
6.0L V12	1999-07	3.504	3.130	4.016	2.657	1.968	5.437	8.189	1.181
200 I6	1963-83	3.680	3.126	4.080	2.249	2.124	4.715	7.808	1.511
250 I6	1969-80	3.680	3.910	4.080	2.399	2.124	5.880	7.808	—
240 I6	1965-72	4.000	3.180	4.480	2.399	2.123	6.795	10.000	1.605
300 I6	1965-96	4.000	3.980	4.480	2.399	2.123	6.210	10.000	1.757
221 V8	1962-63	3.500	2.870	4.380	2.249	2.123	5.155	8.206	1.595
255 V8	1979-82	3.680	3.000	4.380	2.249	2.123	5.155	8.206	1.600
260 V8	1962-64	3.800	2.870	4.380	2.249	2.123	5.155	8.206	1.600
289	1963-68	4.000	2.870	4.380	2.249	2.123	5.155	8.206	1.605
302	1968-96	4.000	3.000	4.380	2.249	2.123	5.090	8.206	1.605
302 BOSS	1969-70	4.000	3.000	4.380	2.249	2.123	5.150	8.201-8.210	1.530
302 Ford Performance	³	4.000	3.000	4.380	2.249	2.123	5.150	8.201-8.210	³
351W	1969-70	4.000	3.500	4.380	3.000	2.311	5.956	9.480	1.769
351W	1971-96	4.000	3.500	4.380	3.000	2.311	5.956	9.503	1.769
351 Ford Performance	³	4.000	3.500	4.380	2.749	2.311	5.956	9.503	³
351 Ford Performance	³	4.000	3.500	4.380	2.249	2.311	5.780	9.206	³
351C BOSS	1970-74	4.000	3.500	4.380	2.749	2.311	5.780	9.206	1.647
351M	1975-85	4.000	3.500	4.380	3.000	2.311	6.580	10.297	1.947
400	1971-81	4.000	4.000	4.380	3.000	2.311	6.580	10.292-10.302	1.647
352	1960-66	4.000	3.500	4.630	2.749	2.438	6.540	10.170	1.825
390	1961-71	4.050	3.780	4.630	2.749	2.438	6.489	10.170	1.775
406	1962-63	4.130	3.780	4.630	2.749	2.438	6.489	10.170	1.745
410	1966-67	4.050	3.980	4.630	2.749	2.438	6.489	10.170	1.674
427	1963-68	4.230	3.780	4.630	2.749	2.438	6.489	10.170	1.752
428	1966-70	4.130	3.980	4.630	2.749	2.438	6.489	10.170	1.674
429 STD	1968-73	4.360	3.590	4.900	3.000	2.500	6.605	10.300 (1968-70)	1.890
429 STD	1968-73	4.360	3.590	4.900	3.000	2.500	6.605	10.310 (1970 1/2-71)	1.890
429 CJ/SCJ	1969-70	4.360	3.590	4.900	3.000	2.500	6.605	10.322 (1972-73)	1.890
429 BOSS (S)	1969	4.360	3.590	4.900	3.000	2.500	6.549	10.300	1.926
429 BOSS (T)	1969-70	4.360	3.590	4.900	3.000	2.500	6.605	10.300	1.870
460/460 Ford Performance	1969-96	4.360	3.850	4.900	3.000	2.500	6.605	10.322 (1972-96)	1.756

¹ Car (EAO)

² Ranger/Bronco II

³ Non-production blocks. Dimensions for reference

⁴ 3.8L SC #1-2-3 – 2.5190", #4 – 2.5096"

⁵ Sport 2000 – 1.6395"

⁶ 1997 – 5.482"

⁷ 1997 – 1.181"

⁸ 3.9L V8 used in the Thunderbird and Lincoln LS is based on the Jaguar® V8 design

⁹ Aftermarket from Ford Performance

NOTES:

- All 4-cylinder (except 1.6L Kent) and all V6 engines are metric. Dimensions shown in inches
- 3.9L V8 used in the Thunderbird and Lincoln LS is based on the Jaguar® V8 design
- 6.0L V8, 6.4L V8 and 7.3L V8 – ITEC® Power Stroke

ENGINE SWAP SIZE CHART

5.0L 4V TI-VCT ENGINE

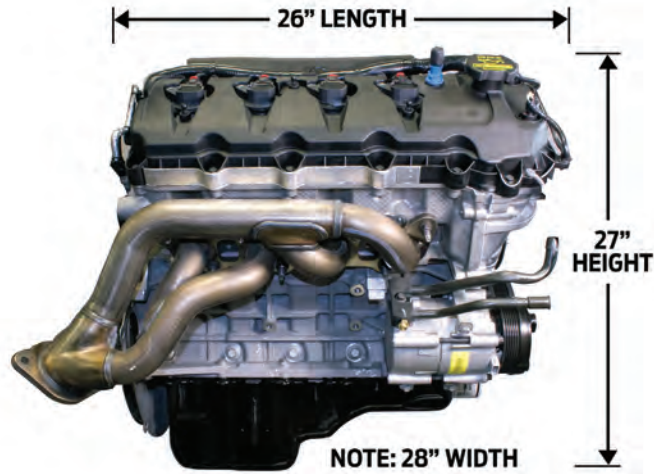

4.6L MODULAR ENGINE

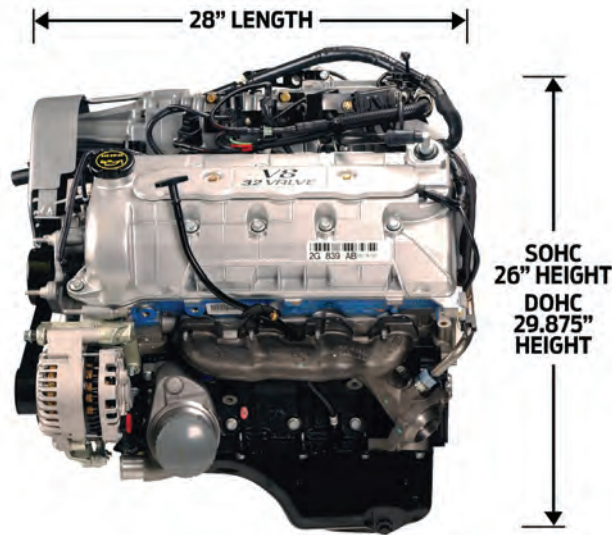

302/351W/460 ENGINE

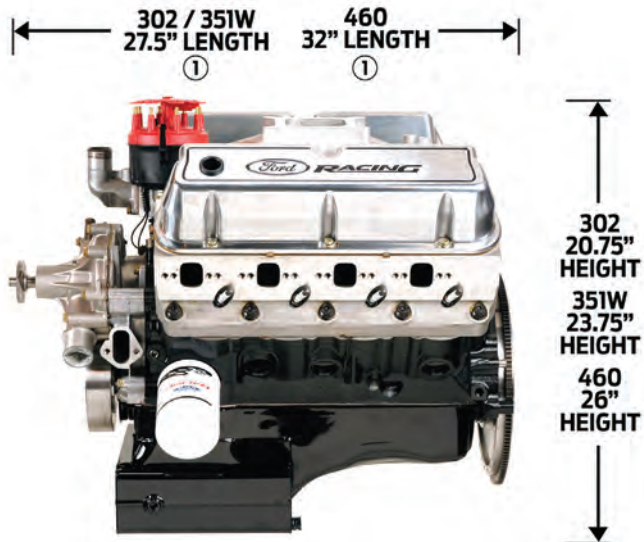



FORD ENGINE ELECTRONICS / FUEL INJECTION

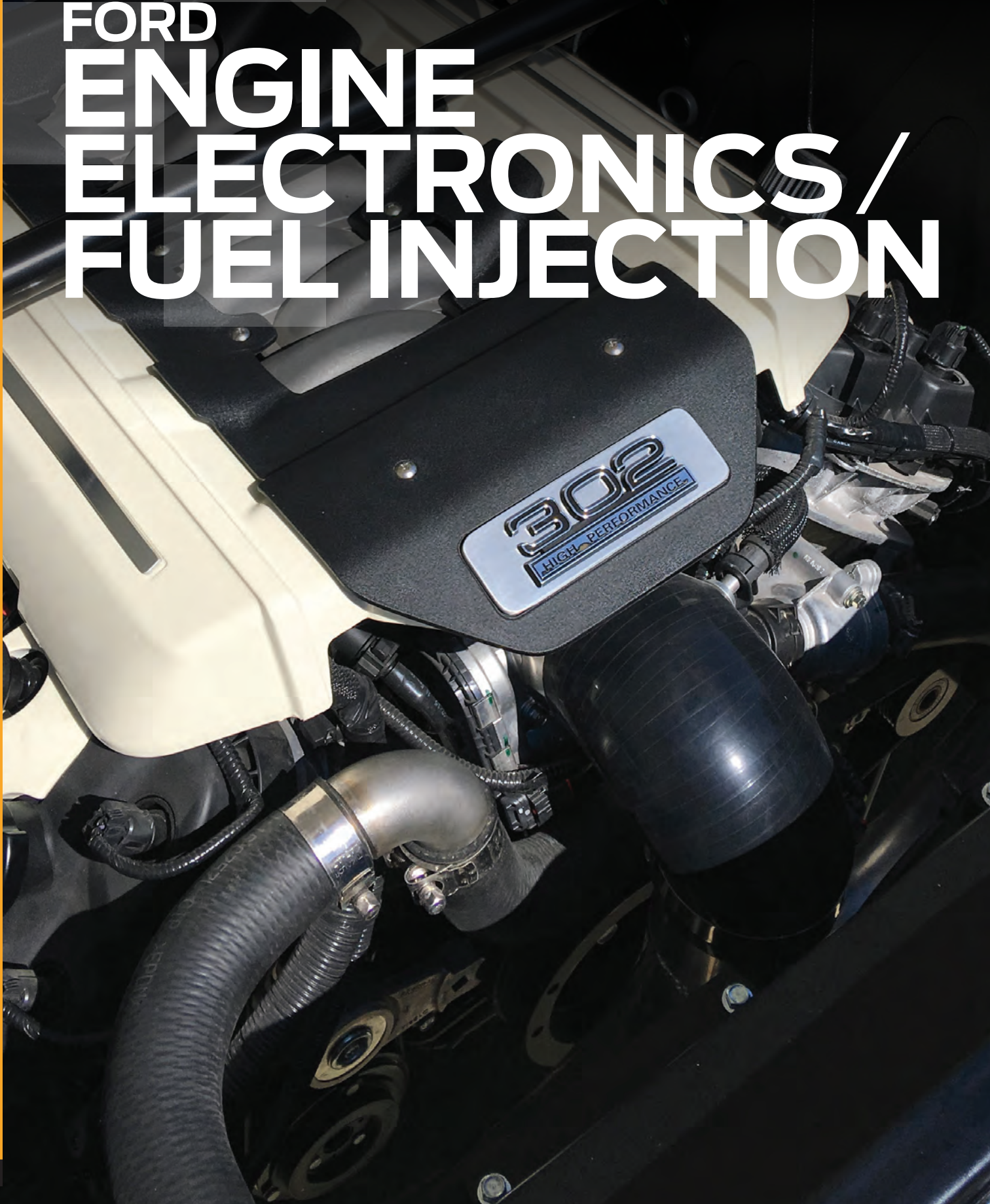

ENGINE ELECTRONICS | FUEL INJECTION

NEW 2018-2019 GEN 3 COYOTE CONTROL PACK – AUTOMATIC TRANSMISSION

M-6017-M50BA

Designed to run 2018-2019 5.0L Coyote (Gen 3) automatic transmission engines M-6007-M50CAUTO, with 10R80 Mustang GT 10-speed transmission

Includes:

- PCM with Ford Performance calibration
- Electronic Throttle Control accelerator pedal, eliminating throttle cable routing problems
- Unique control pack harness, which replaces the stock body harness and is designed for custom vehicle builds
- OBD-II diagnostic port to assist in vehicle calibration upload and problem diagnosis
- Power distribution module
- Air box
- Air inlet tube
- MAF sensor
- Upper and lower radiator hoses
- HEGO sensors

**2.3L ECOBOOST® ENGINE CONTROL PACK**

M-6017-23T

- Includes bodyside harness, PCM and sensors necessary to run a 2.3L EcoBoost® engine in most applications
- Recommended for use with M-6007-23T Crate Engine
- Requires return-style fuel system
- Retains factory technology, such as electronic throttle, variable cam timing, and turbo boost control
- See instructions for full bill of materials

**2013-2016 3.5L ECOBOOST® CONTROL PACK – MANUAL TRANSMISSION**

M-6017-35CNTRL

- Wiring and engine controller for 3.5L EcoBoost® with manual transmission
- Designed to run the M-6007-35T Crate Engine
- Includes PCM with Ford Performance calibration
- Includes electronic throttle control accelerator pedal – eliminates throttle cable routing problems
- Unique control pack harness replaces stock body harness and is designed for custom vehicle builds
- Features OBD-II diagnostic port to assist in vehicle calibration upload and problem diagnosis
- Includes power distribution module, air-box, inlet tube and HEGO sensors
- PCM with Ford Performance calibration requires return-type fuel system; will not work with returnless fuel system
- Visit performance.ford.com for detailed installation instructions and bill of materials

NOTE: Installation of this PCM in any originally equipped 3.5L EcoBoost® vehicle will result in a no-start condition.

NOTE: This will work on 2013-2016 F-150 3.5L EcoBoost® engines.

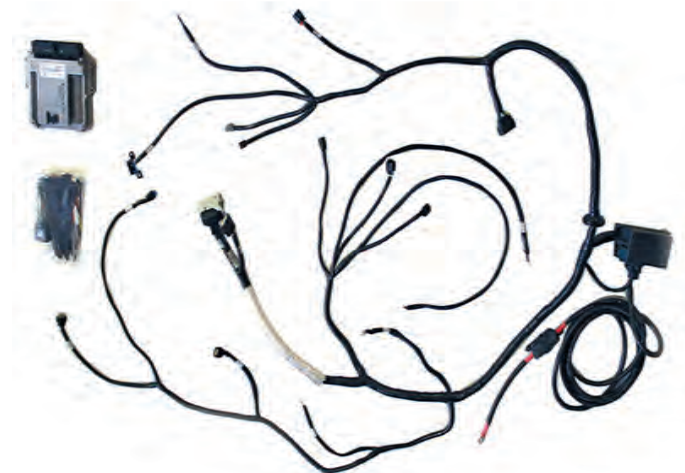

ENGINE ELECTRONICS / FUEL INJECTION (CONTINUED)

2015-2017 COYOTE 5.0L CONTROL PACK – AUTOMATIC TRANSMISSION M-6017-M50A

Take the complexity and mystery out of wiring a late model 5.0L Coyote engine!

Designed to run 2015-2017 5.0L 4V Ti-VCT Coyote auto transmission engines, with 6R80 Mustang GT 6-speed auto transmission. Manual transmission engines require GU5Z-12A581-EF Engine Harness available from your local Ford dealer.

- Includes PCM with Ford Performance calibration
- Includes electronic throttle control accelerator pedal, which eliminates throttle cable routing problems
- Unique control pack harness replaces stock body harness and is designed for custom vehicle builds
- Features OBD-II diagnostic port to assist in vehicle calibration upload and problem diagnosis
- Includes power distribution module, air-box, air inlet tube, MAF sensor, upper and lower radiator hoses and HEGO sensors
- PCM with Ford Performance calibration requires return-type fuel system; will not work with returnless fuel system

NOTE: Installation of this PCM in a 2015-2017 Mustang GT will result in a no-start condition.

NOTE: Not for use with a 2015-2017 F-150 5.0L Coyote engine.



5.0L COYOTE ENGINE HARNESS M-12508-M50

- Fits 2011-2014 Coyote 5.0L engine with BOSS 302 or CJ intake manifold
- 2/27/12 and newer VCT solenoids BR3Z-6M280-D required
- Compatible with Ford Performance Parts M-6017-A504V Control Pack
- Can be used as a core for stand-alone EFI installations
- Used on M-6007-A50XS Crate Engine



5.0L COYOTE AUTO TRANS ENGINE HARNESS M-12508-M50A

- Fits late, Gen 2 (2016-2017 MY) 5.0L Coyote engines
- This engine harness is used with automatic transmission vehicles
- Allows the engine to be used in conjunction with an automatic transmission
- Harness connector is compatible with Ford 6R80 automatic transmissions

NOTE: Fits late-style Ford Performance M-12029-M50E Coil on Plugs.



2015-2017 COYOTE 5.0L CONTROL PACK – MANUAL TRANSMISSION

M-6017-504V

Take the complexity and mystery out of wiring a late model 5.0L Coyote engine!

Designed to run 2015-2017 5.0L 4V Mustang Coyote engines, M-6007-M50A and M-6007-A50NAA 5.0L 4V Ti-VCT crate engines with manual transmission.

NOTE: Not for use with 2015-2017 F-150 5.0L Coyote engines.

- Includes PCM with Ford Performance calibration
- Includes electronic throttle control accelerator pedal, which eliminates throttle cable routing problems
- Unique control pack harness replaces stock body harness and is designed for custom vehicle builds
- Features OBD-II diagnostic port to assist in vehicle calibration upload and problem diagnosis
- Includes power distribution module, air-box, air inlet tube, MAF sensor, upper and lower radiator hoses and HEGO sensors
- PCM with Ford Performance calibration requires return-type fuel system; will not work with returnless fuel system
- For 2011-2014 engines, use M-6017-A504VA Control Pack
- For 2015-2017 automatic transmission version control pack that works in conjunction with 6R80 transmission, use M-6017-M50A

NOTE: Supercharged versions and M-6007-A50SCA (lower compression ratio) require custom calibration.

NOTE: Installation of this PCM in a 2015-2017 Mustang GT will result in a no-start condition.

NOTE: Remanufactured PCM.





PERFORMANCE THROTTLE BODIES FOR VEHICLES EQUIPPED WITH ELECTRONIC THROTTLE CONTROL (ETC)

Electronic throttle control was introduced on the Mustang in 2005. Its introduction has made attention to detail and set up of replacement throttle bodies even more critical than in the past. Ford Performance throttle bodies are tested and engineered to give customers trouble-free operation and are set up from the factory ready to install. Custom ECU calibration is required.







All Ford Performance ETC throttle bodies feature:

- All factory sensors installed – no need to try to take apart your original throttle body
- Calibrated for idle airflow using the same procedure as production throttle bodies
- Precision billet construction with tapered inlet for consistent high flow
- Aluminum construction for great looks
- Some throttle bodies feature CNC'd "Ford Racing" logo
- Validation through hundreds of hours of dyno, racing and street performance driving

PART NUMBER	ENGINE	FITS	SIZE	REQUIRES	NOTES
87 MM MUSTANG BULLITT™ THROTTLE BODY					
M-9926-M50B 	5.0L 4V Coyote	2018-2019 Mustang GT	87 mm	M-9474-M5087 Throttle Body Adapter for use on Intake Manifold	Original equipment on 2019 Mustang BULLITT™ Can also be used with M-9424-M52 Intake Manifold without adapter
2015-2017 MUSTANG GT350 THROTTLE BODY 87 MM					
M-9926-M52 	5.2L	2015-2017 Mustang GT350	87 mm		New stock replacement Can be used with M-9424-M52 Intake Manifold Includes fasteners
2.3L ECOBOOST® 70 MM BILLET THROTTLE BODY					
M-9926-M2370 	2.3L EcoBoost®	2015-2017 Mustang	70 mm		Replaces production 60 mm throttle body Billet aluminum construction with polished exterior Complete bolt-on replacement fully compatible with the production air intake system Includes new mounting bolts

(Continued on next page)

ENGINE ELECTRONICS / FUEL INJECTION (CONTINUED)
PERFORMANCE THROTTLE BODIES FOR VEHICLES EQUIPPED WITH ELECTRONIC THROTTLE CONTROL (ETC) (Continued)

PART NUMBER	ENGINE	FITS	SIZE	REQUIRES	NOTES
2011-2014 MUSTANG 5.0L 90 MM THROTTLE BODY					
 M-9926-M5090	5.0L DOHC Coyote	2011-2014 Mustang GT/ 2012-2013 BOSS 302 (stock 80 mm) (NOT compatible with 2015 Mustang GT)	90 mm	M-9474-M50 Adapter for OEM Mustang GT 5.0L 4V Coyote intake M-9474-M50B Adapter for Ford Performance M-9424-M50BR BOSS Intake Requires use of 4" I.D. silicone hose adapter or reducer 4" air inlet tube is recommended for maximum horsepower Calibration required	M-9474-M50 Adapter rotates throttle body approximately 15° counterclockwise M-9680-M50 Engine Cover covers throttle body on 5.0L 4V Coyote intake 4" diameter leading edge larger-than-stock throttle body When using factory 3.5" diameter air inlet tube, the molded rubber throttle body hose must be removed Includes jumper harness M-9424-M50BR BOSS Intake can be port matched to accept throttle body without adapter, requires custom gasket/RTV CFM rating: 1132 cfm; with adapter: 1101 cfm (stock 80 mm throttle body: 913 cfm)*
2007-2014 MUSTANG SHELBY GT500 THROTTLE BODY					
 M-9926-MSVT	5.4L SC	2007-2014 Shelby GT500	60 mm		New stock replacement
2007-2014 SHELBY GT500 DUAL 65 MM THROTTLE BODY					
 M-9926-CJ65	5.4L SC	2007-2014 Shelby GT500 (stock dual 60 mm)	Dual bore 65 mm	Calibration required	Fits 2011-2014 Mustang GT with M-6066-MGT624D Ford Performance Supercharger Kit Fits M-9424-M50CJ 5.0L Cobra Jet Intake Manifold CFM rating: 1517 cfm*
2005-2010 MUSTANG GT THROTTLE BODY					
 M-9926-MGT	4.6L 3V	2005-2010 Mustang GT	55 mm		New stock replacement
2005-2010 MUSTANG GT BILLET THROTTLE BODY					
 M-9926-3V	4.6L	2005-2010 Mustang GT (stock dual 55 mm)	Dual bore 62 mm	Calibration required	CFM rating: 1306 cfm (stock dual 55 mm throttle body: 953 cfm)* Works well with Ford Performance M-6550-3V Hot Rod Camshafts, M-6049-N3VPA High-Performance CNC-Ported 3V Cylinder Heads and M-9424-463V Performance Intake Manifold
BOSS 302 90 MM THROTTLE BODY INTAKE SPACER					
 M-9474-M50B	BOSS 302	2011-2014 Mustang GT/ 2012-2013 BOSS 302	90 mm	M-9424-M50BR Intake and M-9926-M5090 Throttle Body	Spacer used to adapt M-9926-M5090 90 mm Billet Aluminum Throttle Body to M-9424-M50BR 2012-2013 BOSS 302 Intake

(Continued on next page)

*All CFM ratings are calibrated at 28" of water, measured on SuperFlow® SF-1020 Flow Bench.

For important information about the proper usage of performance parts, please see page 2. See pages 217-225 for important safety, emissions and warranty information.

PERFORMANCE THROTTLE BODIES FOR VEHICLES EQUIPPED WITH ELECTRONIC THROTTLE CONTROL (ETC) (Continued)

PART NUMBER	ENGINE	FITS	SIZE	REQUIRES	NOTES
5.0L 4V COYOTE 90 MM THROTTLE BODY INTAKE SPACER					
M-9474-M50 	5.0L 4V Coyote	2011-2014 Mustang GT	90 mm	M-9926-M5090 Throttle Body and 5.0L Mustang GT Ti-VCT Intake Manifold	Spacer rotates throttle body approximately 15° counterclockwise to clear intake cover

MECHANICAL REPLACEMENT THROTTLE BODIES FOR AFTERMARKET ENGINE CONTROL SYSTEMS

For those enthusiasts who want to run a late model engine with an aftermarket ECU that requires a mechanical linkage, Ford Performance offers throttle bodies to make the conversion easy. All mechanical linkage throttle bodies feature a 2003-2004 Cobra-style linkage and throttle cable connection. Throttle cable and cable stop plate are not included and must be custom fabricated. Our mechanical throttle bodies are legal for NHRA® competition on the Mustang Cobra Jet. Check www.NHRA.com for a full list of throttle bodies for the 2008-2014 Cobra Jet.

PART NUMBER	ENGINE	FITS	SIZE	REQUIRES	NOTES
SUPER COBRA JET MECHANICAL THROTTLE BODY					
M-9926-SCJM 	5.4L SC	2010 Super Cobra Jet	Mono-blade	Requires aftermarket engine control system	

2001-2004 F-150 LIGHTNING MASS AIR METER M-12579-L54



- Fits 2001-2004 F-150 Lightning
- Stock replacement 90 mm Lightning mass air meter
- Requires recalibration for use on other vehicles



2005-2009 MUSTANG GT DUAL FUEL PUMP KIT M-9407-GT05



Fits 2005-2009 Mustang GT.
For 2010 use M-9407-MSVTA

- Includes harness, dual fuel pumps, drop in housing and fuel pump driver module from the 2007-2009 Mustang Shelby GT500
- Includes all installation hardware
- Highly recommended for any application making over 400 hp
- Does not include calibration, COMPUTER CALIBRATION REQUIRED, sold for tuner use



NOTE: Use of this kit in a 2010 Mustang will result in an incorrect fuel gauge reading

COBRA JET 123 MM BILLET MAF HOUSING M-9600-CJ



Add to your underhood “bling” factor with this massive mass airflow sensor housing that looks as good as it performs!

- 123 mm mass airflow sensor housing
- Cobra Jet mass air meter housing – recommended for highly modified 2007-2012 Mustang GT500s
- Proven to support over 800 hp in 2007-2011 Shelby GT500 applications
- Fits production air tube
- Precision CNC'd billet aluminum, polished finish
- This kit includes the housing and mounting tab
- Perfect upgrade to existing Ford Racing Mustang SVT power upgrade, cold air and supercharger kits!
- Recommend M-9601-D Air Filter
- Does not include calibration, COMPUTER CALIBRATION REQUIRED, sold for tuner use



SUPER COBRA JET 140MM MAF TUNER KIT M-9600-SCJ



2010 Super Cobra Jet mass air meter housing – recommended for highly modified 2007-2011 Shelby GT500

- 140 mm mass airflow sensor housing
- Proven to support over 1100 hp in 2007-2011 Shelby GT500 applications
- Precision CNC'd billet aluminum
- Polished finish
- Perfect upgrade to existing Ford Racing Mustang SVT power upgrade, cold air and supercharger kits!
- Does not include calibration, COMPUTER CALIBRATION REQUIRED, sold for tuner use
- Recommend M-9601-D Air Filter
- 140 mm MAF housing requires a custom air tube and may have interference issues with the factory hood when using production engine mounts



87 MM THROTTLE BODY ADAPTER M-9474-M5087



- Adapter to use the GT350 87mm throttle body with the 2015-17 Mustang GT intake manifold
- Includes 4 throttle body bolts



PROPERLY SELECTING ELECTRONIC FUEL INJECTION COMPONENTS



NOT ALL INJECTORS ARE ALIKE

All Ford Performance injectors are held to the same original equipment specifications that are used in millions of Ford vehicles currently on the road. With mandatory emissions requirements for 100,000 miles, our injectors have to be durable and consistent. Some of our competitors' injectors are not built to original equipment standards and are often held to no specific build tolerance.

Don't trust your performance vehicle to just any injector, trust the brand with millions of vehicles on the road and over 100 years of racing experience, Ford Performance!

"After working with the Ford Performance 80 lb/hr injectors in several projects, I'm thoroughly convinced that they are the best all-around fuel injectors for most of today's Mustang performance applications – naturally aspirated and/or with power adders."

– KJ Jones, 5.0 Mustang & Super Fords

PART NUMBER (SETS OF 8)	FLOW RATE	IMPEDANCE	LENGTH	CONNECTOR	COLOR
M-9593-LU24A	24 lb/hr	11-18 ohms	L	USCAR®	Black
M-9593-M39	39 lb/hr	11-18 ohms	L	USCAR®	Dark Blue
M-9593-G302	47 lb/hr	11-18 ohms	M	USCAR®	Black w/Yellow Stripe
M-9593-LU47	47 lb/hr	11-18 ohms	L	USCAR®	Black w/Silver Tip
M-9593-MU52	52 lb/hr	11-18 ohms	M	USCAR®	Black
M-9593-LU60	 60 lb/hr	11-12 ohms	L	USCAR®	Black
M-9593-LU80	 80 lb/hr	11-12 ohms	L	USCAR®	Black w/Blue Tip

All injector flow rates are quoted at a delta pressure of 39.15 psi. To convert to a delta pressure of 43.5 psi, multiply flow rate by 1.054.

⚠ WARNING: Cancer www.P65Warnings.ca.gov

BODY STYLE

CONNECTORS



EV1



EV6



EV14



Jetronic®/
Minitimer®



USCAR®

LENGTH

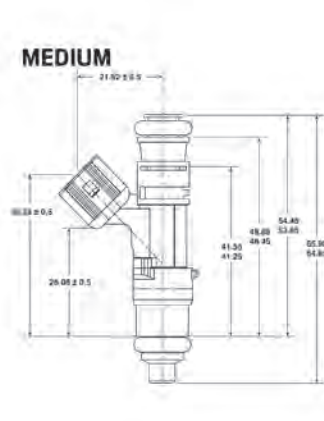
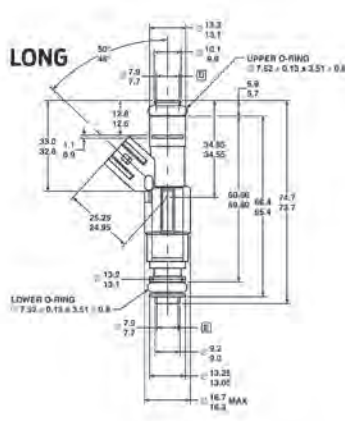
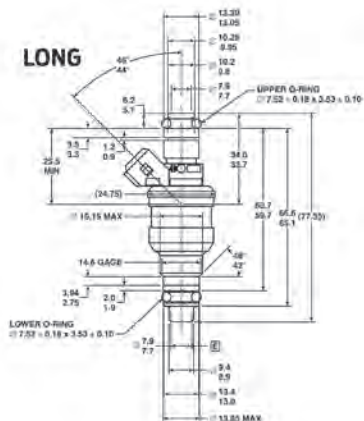

Do it well, or not at all.

AGREED.



For more than 35 years Ford Performance Parts has been producing and developing performance parts with enthusiasts in mind. Whether you are building from the ground up or working to get that extra tenth of a second, Ford Performance delivers the products you need. We're proud to offer crate engines and performance components that are designed and engineered to rigorous Ford Performance standards. They have earned their right to wear the Ford Oval.



**FORD PERFORMANCE
PARTS**

PERFORMANCEPARTS.FORD.COM

FORD DRIVELINE COMPONENTS

FORD 216064



TECH TIPS

CLUTCH/TRANSMISSION INSTALLATION TIPS 1986 and newer V8 Mustang

The flywheel-to-crankshaft bolts must be hand-torqued to 75-85 lb-ft (302/351W) and 54-64 lb-ft (4.6L).

The 10.5" pressure plate bolts must be torqued to 12-24 lb-ft and 11" pressure plate bolts to 33 lb-ft + 1/4 turn.

Be sure to use the alignment dowels in the flywheels.

Pressure plate bolts and alignment dowels for the 10.5" clutch can be purchased using Part No. M-6397-A302. N808969-S100 Pressure Plate Bolts and D1FZ-6397-B Alignment Dowels are for the 11" pressure plate.

Evenly tighten bolts in a circular direction one turn at a time.

Bellhousing alignment is crucial for proper clutch and transmission function.

Due to production tolerances of engine blocks and bell housings, it is possible for the transmission center line and crankshaft center line to be misaligned. Misalignment can cause transmission gear wear, transmission jumping out of gear, driveline vibration, clutch pedal vibration, pilot bearing noise, release bearing noise or excessive clutch spin time. It may also damage the pilot bearing, transmission mainshaft bearing and clutch hub. It will also cause harsh shifting.

Before installing the bellhousing, check the block mounting surface and bellhousing surfaces for nicks, dents, paint debris, etc. These are some things that could affect the accuracy of your measurements.

HOW TO CHECK BELLHOUSING ALIGNMENT

The first step is to check bellhousing face runout. You are checking for parallelism of the back of the bellhousing to the back of the block. Install the dial indicator (as shown in Fig. 1). Rotate the crankshaft and mark down the reading. Be sure to push the crankshaft against the thrust bearing for an accurate reading. Maximum runout is .010. The next step is checking bellhousing bore runout. You are checking to see if the bellhousing bore center line is aligned with crankshaft center line. Reposition the dial indicator in the bellhousing bore (as shown in Fig. 2). Rotate the crankshaft and mark down the readings. Maximum out of concentricity is .015. If the bore runout is out of spec, install appropriate offset dowels.

Offset alignment dowels can be purchased from Lakewood®.

.007 PN 15950

.014 PN 15960

.021 PN 15970

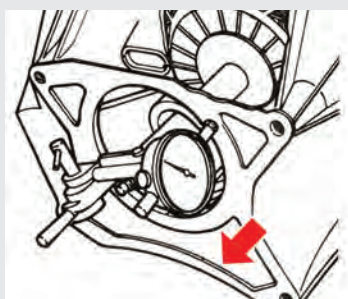

FIG 1: Face of housing (Must be clean and free of nicks, burrs or foreign material.)

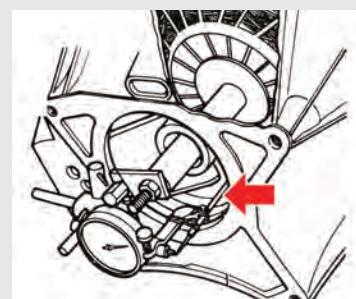

FIG 2: Level tip rides on bore surface. This surface must be clean and free of nicks, burrs or foreign material.

TREMEC® 6-SPEED TRANSMISSIONS

M-7003-M6266 2.66 1st Gear/26 Spline

Gear ratios: 1st 2.66; 2nd 1.78; 3rd 1.30; 4th 1.00; 5th 0.80; 6th 0.63

M-7003-M6295 2.97 1st Gear/26 Spline

Gear ratios: 1st 2.97; 2nd 2.10; 3rd 1.46; 4th 1.00; 5th 0.74; 6th 0.50

Magnum T-56 technology from Tremec® provides more torque capacity and smoother shifting than 6-speeds of the past. Requires aftermarket bellhousing available through Quicktime® Bellhousings. For small block Ford 302/351, use Quicktime® Part No. 8031. For modular 4.6L/5.0L/5.4L, use Quicktime® Part No. 8080.

- Fits SBF, 4.6L SOHC/DOHC and 5.0L Ti-VCT engines
- Can be used in 1999-2004 Mustang and Cobra
- May require shorter driveshaft, modified crossmember/trans mount and other minor modifications
- 700 lb-ft torque capacity
- Input shaft is 26 spline; output shaft is 31 spline
- Provision for both mechanical and electronic speedometer
- Mechanical speedo drive gear has 7 teeth
- Electronic speedo rotor has 12 positions

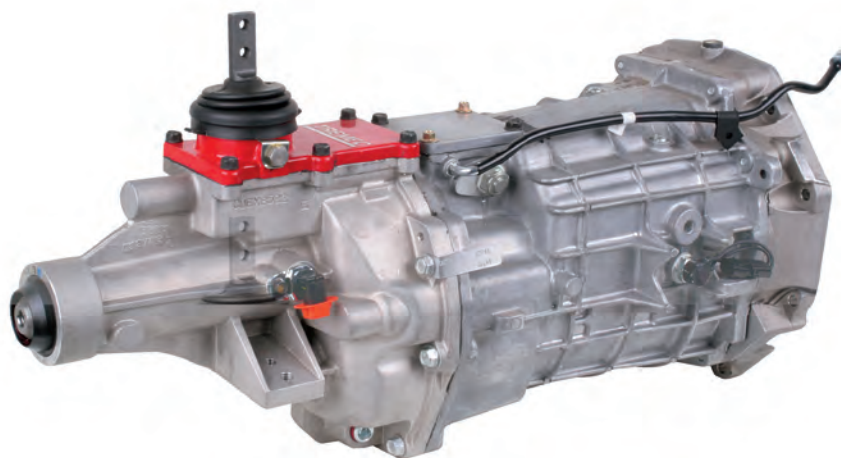

M-7003-M6295 shown

DRIVELINE COMPONENTS (CONTINUED)

TREMEC® 6-SPEED TRANSMISSION

M-7003-M6297 2.97 1st Gear/26 Spline

- Fits SBF, 4.6L SOHC/DOHC and 5.0L Ti-VCT engines
- Can be used in 1999-2004 Mustang and Cobra
- For SBF 302/351 use Quicktime® bellhousing Part No. 8031
- For modular 4.6L/5.0L/5.4L use Quicktime® bellhousing Part No. 8080
- May require shorter driveshaft, modified crossmember/trans mount and other minor modifications
- 700 lb-ft torque capacity
- Gear ratios: 1st 2.97, 2nd 1.78, 3rd 1.30, 4th 1.00, 5th .80, and 6th .63
- Input shaft is 26 spline; output shaft is 31 spline
- Provision for both mechanical and electronic speedometers
- Mechanical speedometer drive gear has 7 teeth
- Electronic speedometer rotor has 12 positions

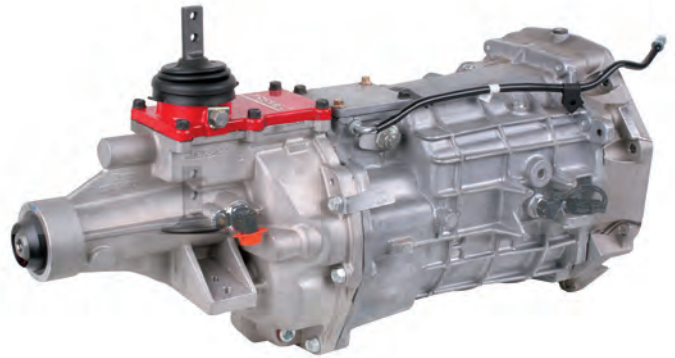

TREMEC® TRANSMISSION KIT MAGNUM XL

M-7003-M6XL

- Fits 2005-2014 Mustang GT
- 2.97 gear ratio
- Trans mount isolated shifter and shift ball
- 700 lb-ft torque capacity
- New extended length tail section designed to eliminate the semiremote shifter
- SFI-approved steel bellhousing
- Reuses the OEM hydraulic clutch release system
- Includes swap-specific steel crossmember and OE-quality rubber transmission mount

NOTES:

- Users will need to convert to a 26-spline clutch disc and 1-piece slip yoke-style prop shaft (not included)
- Magnum XL transmissions are designed to accept the factory hydraulic release bearing from a 2005-current Mustang GT
- GT500 bearings may also be used but will require a custom adaptor to maintain proper stack up (not included)
- 2005-2010 Mustang applications are a direct plug-and-play with regards to the speedometer
- 2011-up models will require speedometer recalibration via ECU tuning or a separate plug-in signal converter from sine to hall-effect signal, such as the Abbott Enterprises ERA or Dakota Digital SGI-1 (not included)
- 2015-2019 model installation kits are not currently available



TREMEC® 5-SPEED EXTRA HD TRANSMISSION (CLOSE RATIO)

M-7003-R58C

- 600 lb-ft torque capacity
- Gear ratios: 1st 2.87; 2nd 1.90; 3rd 1.34; 4th 1.00; 5th 0.82
- Features improved shift forks, one-piece counter-shaft, gears made of 4615 steel, which increases the torque capacity over that of the M-7003-R58 model
- Input shaft is 26 spline and output shaft is 31 spline
- Requires a unique M-6392-R58 Bellhousing to install in a 1979-1995 Mustang
- To fit in a 1979-1993 Mustang, use M-5059-A Crossmember
- To fit in a 1994-1995 Mustang, modify vehicle crossmember, lengthen driveshaft .625" and use E6ZZ-7515-A Clutch Fork
- 31-spline driveshaft yoke required
- Requires unique M-7550-T302 Clutch Disc (10.5") designed for use with 26-spline input
- Can be used in 4.6L applications with M-6392-M46 Bellhousing and M-7560-T46 Clutch Kit (11")
- Tremec® recommends Synchronesh® fluid

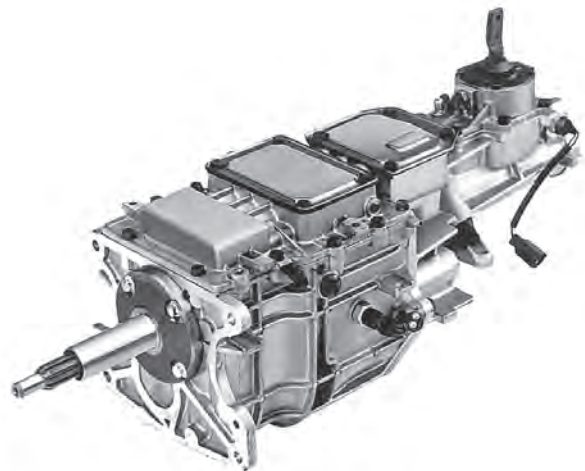

TREMEC® 5-SPEED EXTRA HD TRANSMISSION (CLOSE RATIO 26 SPLINE) M-7003-R58H

- Close ratio 1st through 4th
- 600 lb-ft torque capacity
- Gear ratios: 1st 2.87; 2nd 1.90; 3rd 1.34; 4th 1.00; 5th 0.68
- Features improved shift forks, one-piece counter-shaft, gears made of 4615 steel, which increases the torque capacity over that of the M-7003-R58 model
- Input shaft is 26 spline; output shaft is 31 spline
- Requires M-6392-R58 Bellhousing to install in a 1979-1995 Mustang
- For 1979-1993 Mustang applications, use M-5059-A Crossmember (1979-1981 will require modification)
- For 1994-1995 Mustang applications, modify vehicle crossmember, lengthen driveshaft .625" and use E6ZZ-7515-A Clutch Fork
- 31-spline driveshaft yoke required
- Requires unique M-7550-T302 Clutch Disc (10.5") designed for use with 26-spline input
- Can be used in 4.6L applications with M-6392-M46 Bellhousing and M-7560-T46 Clutch Kit (11")
- Tremec® recommends Synchronesh® fluid

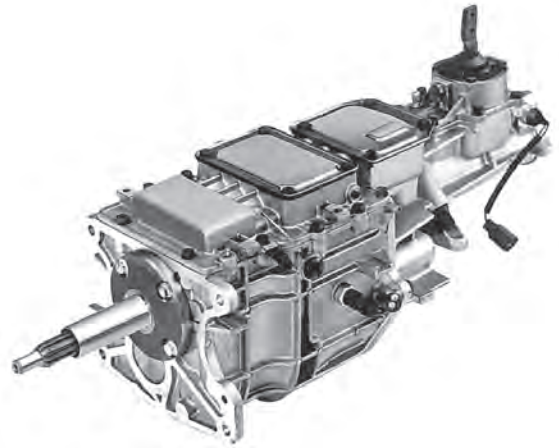

MUSTANG BOSS 302 MANUAL TRANS COOLER AIR SCOOP M-5025-MBR

- Transmission cooler scoop original equipment on 2012-2013 Mustang BOSS 302 Laguna Seca
- Fits 2011-2014 Mustang GT with manual transmission and 2012-2013 Mustang BOSS
- Replaces OEM pencil brace



ADJUSTABLE #3 CROSSMEMBER TRANSMISSION MOUNT M-5059-A

This crossmember is a double hump design that simplifies installation of dual exhaust systems on Fox-bodied vehicles.

The outer tubes are not welded to the center support, and thus can be adjusted to fit most engine/transmission combinations. It directly fits all Fox-bodied vehicles with a 4.5" dimension between the crossmember mounting brackets. It can be used on Fox vehicles with a 2.75" mounting dimension by relocating the brackets.

It does not fit 1982 and later Continental or 1984 and later Mark VII, because they have a unique crossmember.

4.5" MOUNTING DIMENSION		2.75" MOUNTING DIMENSION	
YEAR	FOX VEHICLE	YEAR	FOX VEHICLE
1980-1988	T-Bird/Cougar	1978-1981	Fairmont/Zephyr
1982-1993	Mustang/Capri	1979-1981	Mustang/Capri
1982	Fairmont/Zephyr	1981-1982	Granada/Monarch
1983 and later	LTD/Marquis		



AUTOMATIC TRANSMISSION DIPSTICK/TUBES

- M-6750-D303 Fits case fill C-4 transmissions
- M-6750-E303 Fits C-6 transmissions

- Chrome dipstick, tube assembly and bracket



M-6750-D303



M-6750-E303

WARNING: Cancer www.P65Warnings.ca.gov

T-5 REBUILD KIT M-7000-A

This 94-piece world class T-5 transmission rebuild kit can be used on all of the following T-5 applications:

- M-7003-Z Transmission
- M-7003-A Transmission
- M-7003-X Transmission
- 1985-1995 5.0L Mustang
- 1985-1993 2.3L Mustang
- 1985-1986 2.3L Mustang SVO
- 1985-1988 2.3L Thunderbird Turbo Coupe
- 1994-current 3.8L V6 Mustang with T-5 transmission

NOTE: ① 1987-1993 models will require additional input bearing and race. See your Ford and Lincoln dealer.





DRIVELINE COMPONENTS (CONTINUED)

**TREMEC® UPGRADED SUPER-DUTY T-5 TRANSMISSION
M-7003-Z**

- 1979-1993 Mustang V8 only
- Heavy-duty "World Class" T-5 5-speed manual transmission with short throw shifter
- 300 lb-ft torque capacity
- Gear ratios: 1st 2.95; 2nd 1.94; 3rd 1.34; 4th 1.00; 5th 0.63
- Double moly 2nd speed, 3rd speed and countershaft cluster gears
- Carbon fiber 3-4 blocker rings
- Improved synchronizers and bearings
- 1-1/16" diameter 10-spline input shaft
- 28-spline output shaft
- 7-tooth speedometer drive gear
- Cobra-style pocket bearing
- Steel input bearing retainer
- Transmission uses Mercon® fluid or Dexron® III

**T-5 BEARING RETAINER**

M-7050-A Fits 1983-1993 V8 applications
M-7050-B Fits 1994-1995 V8 applications



- Replacement T-5 bearing retainer with steel throw-out bearing sleeve
- Fits production and Ford Performance T-5 transmissions
- Length from trans face to end of sleeve is 4.480" for M-7050-A and 5.160" for M-7050-B

**1979-2004 MUSTANG HURST®
T-5/T-45 SHIFTER
M-7210-M**

- Fits T-5 and T-45 transmission. Does not fit Tremec® 3650 transmission, 2001 and newer Mustang Cobra, Mustang BULLITT™ and Mustang GT (3650 transmission has the drain plug in the bottom of the case)
- Fits 1979-1995 V8 Mustang with T-5 transmission
- Fits 1994-2004 V6 Mustang with T-5 transmission
- Fits 1996-2001 V8 Mustang with T-45 transmission
- One-piece 6061-T6 aluminum CNC-machined base
- Positive stops to prevent over-travel
- Super short throw
- Chrome stick and white knob



⚠ **WARNING: Cancer** www.P65Warnings.ca.gov

**2005-2009 MUSTANG GT SHORT THROW SHIFTER
M-7210-MGT**

- Designed by Ford Racing and Hurst®
- Fits 2005-2009 Mustang GT
- Chrome stick with "Ford Racing" white shift knob
- High-lubricity polymer-bearing with unique shifter rod and OE main stamping
- Includes jam nut
- Urethane body vibration isolators
- Reduced throw

**2011-2014 MUSTANG V6/GT 6-SPEED SHIFTER
M-7210-MGTB**

- Fits 2011-2014 Mustang GT, V6 and BOSS 302 with 6-speed manual transmission
- Shorter shift throws than OEM shifter
- Blue anodized shifter handle and bracket
- Includes white "Ford Racing" logo shifter ball. Ford Racing shifter ball and adapter only fits cars originally equipped with leather shift knob. Will not fit vehicles originally equipped with aluminum shift knob
- Vehicles originally equipped with aluminum shift knob require reuse of factory shift knob or installation of BR32-7277-A Shifter Boot
- Retains reverse lock-out

**8.8" RING GEAR BOLT SET
M-4216-A300 Package of 10**

- 7/16"-20 x .875" bolts
- Set of 10 bolts
- Can also be used for automatic transmission flywheels



⚠ **WARNING: Cancer** www.P65Warnings.ca.gov

**302/351 T-5 BELLHOUSING
M-6392-E**

- 1979-1993 5.0L Mustang T-5 bellhousing. Will also fit 289/302/351C/351W
- Can be used as a replacement part or for building a kit car or street rod
- Cast aluminum
- Requires diaphragm-type clutch. With 10-spline input shaft use M-7560-A302N Clutch Kit
- Can be used with M-7007-B Starter Index Plate
- Can be used with M-7553-A302 Clutch Linkage Upgrade Kit



4.6L/5.0L/5.4L MODULAR BELLHOUSING M-6392-M46



- 4.6L/5.4L Tremec® 3550 Cobra R bellhousing
- Use to mate the Tremec® 3550 transmission to the 4.6L/5.0L 4V Ti-VCT/5.4L modular engines
- Minor modification is required for transmission clearance and mounting in some applications
- Cast aluminum production-style bellhousing
- Also works with 5.0L Ti-VCT engine
- Can also be used with M-7007-A Starter Index Plate
- Can also be used with M-7515-A Clutch Release Lever
- Can also be used with M-7771-A Bellhousing Installation Kit

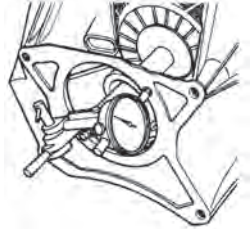

See Bellhousing Alignment Tech Tip on page 169

302/351 BELLHOUSING FOR TREMEC® 5-SPEED M-6392-R58



- Unique bellhousing required for M-7003-R58C and M-7003-R58H Tremec® 5-speed transmission
- Fits 289/302/351C/351W engines with 157-tooth flywheel
- Designed for 1979-1993 Mustang V8 clutch fork
- Requires diaphragm-type clutch. With 10-spline input shaft use M-7560-A302N Clutch Kit
- Can be used with M-7007-B Starter Index Plate
- Can be used with M-7553-A302 Clutch Linkage Upgrade Kit



MODULAR BELLHOUSING INSTALLATION KIT M-7771-A



Modular bellhousing installation kit includes:

- 1 clutch ball stud
- 7 bellhousing-to-block bolts
- 2 starter index plate-to-bellhousing bolts
- Fits M-6392-M46 Bellhousing



NOTE: See M-7007-A for starter index plate

STARTER INDEX PLATE – MODULAR BLOCK AUTOMATIC TRANSMISSION M-6373-A

- Fits 4.6/5.4L modular engine with production automatic transmissions 4R70, 4R75, 4R100
- Metal plate that goes between the block and the transmission bellhousing
- The starter index plate positions the starter to ensure proper starter drive-to-flywheel ring gear alignment



4.6L MANUAL FLYWHEEL BOLTS M-6379-B

- Fits 4.6L modular engines with manual transmission flywheels
- M10 x 1 x 26.5 bolt
- Package of 8



5.0L COYOTE FLYWHEEL BOLT KIT M-6379-C

- Production manual transmission flywheel bolts for the 5.0L Coyote engine
- Includes 8 bolts



10.5" PRESSURE PLATE BOLT AND DOWEL KIT M-6397-A302



- Use with Ford Performance flywheels to align and attach the 10.5" diaphragm-style clutch pressure plate to the flywheel. For 11" clutch application, see M-6397-A46
- This kit includes three dowel pins that are necessary to align and stiffen the pressure plate shell.



NOTE: If these dowels are not used, the clutch may chatter

- This kit includes six 8 mm bolts with integral lock washers

NOTE: Ford Performance and production flywheels have metric bolt holes for diaphragm-style clutches. Ford Performance billet steel flywheels have metric bolt holes for diaphragm-style clutches and 5/16"-18 SAE bolt holes for "long"-style clutches.

PRESSURE PLATE BOLT AND DOWEL KIT M-6397-B46

- For use with Ford Performance and production flywheels on 4.6L and 5.0L Coyote engines to align and attach the 11" 6- or 9-bolt diaphragm-style pressure plate to the flywheel.



- Increased clamp load over stock bolts on 1999-2010 applications (see instructions for proper torque specs)
- Dowels are necessary to align and stiffen the pressure plate shell. If the dowels are not used, the clutch may chatter and the engine vibrate

Kit includes:

- Six dowel pins total, three for early applications, three for later applications
- Nine 10 mm X 1.5 pressure plate bolts for use with 11" modular flywheel

DRIVELINE COMPONENTS (CONTINUED)

STARTER INDEX PLATE – MODULAR BLOCK MANUAL TRANSMISSION
M-7007-A

- Fits 4.6L/5.4L and 5.0 Coyote modular engine with manual transmission except Ford GT
- Fits M-6392-M46 Bellhousing
- Metal plate that goes between the block and the transmission bellhousing
- The starter index plate positions the starter to ensure proper starter drive-to-flywheel ring gear alignment











STARTER INDEX PLATE – SMALL BLOCK MANUAL TRANSMISSION

M-7007-B

- Fits 1979-1995 Mustang V8 with manual transmission and production bellhousing
- Fits bellhousing M-6392-E and M-6392-R58
- Metal plate that goes between the block and the transmission bellhousing
- The starter index plate positions the starter to ensure proper starter drive-to-flywheel ring gear alignment



MANUAL TRANSMISSION FLYWHEELS FOR PUSH ROD ENGINES

PART NUMBER	MATERIAL / WEIGHT	CLUTCH DAMPER ASSEMBLY COUNTER BORE	RING GEAR	CRANK BOLTS	UNBALANCED	APPLICATION
M-6375-A302B ①	 Billet Steel 23 lbs	6.00"	157-tooth	6 bolts	28.2 oz-in	Pre-1981 302 engines and 351 engines using 157T flywheels with 10.5" diaphragm clutch. Meets SFI 1.1
M-6375-A302AB ①	 Aluminum 12 lbs	6.00"	157-tooth	6 bolts	28.2 oz-in	Pre-1981 302 engines and 351 engines using 157T flywheels with 10.5" diaphragm clutch. Reduced rotating mass. Meets SFI 1.1
M-6375-B302 ①	 Cast Iron		157-tooth	6 bolts	50.0 oz-in	1981 and later 302 engines. Direct replacement for 1986-1995 5.0 Mustang
M-6375-C302B ①	 Billet Steel 23 lbs	6.00"	157-tooth	6 bolts	50.0 oz-in	1981 and later 302 engines using 157T flywheels with 10.5" clutch. Meets SFI 1.1
M-6375-D302B ①	 Billet Steel 23 lbs	6.00"	157-tooth	6 bolts	0 oz-in	All small blocks using 157T flywheel, 10.5" diaphragm clutch with 0-unbalance rotating assemblies. Meets SFI 1.1
M-6375-D302AB ①	 Aluminum 12 lbs	6.00"	157-tooth	6 bolts	0 oz-in	All small blocks using 157T flywheel, 10.5" diaphragm clutch with 0-unbalance rotating assemblies. Reduced rotating mass. Meets SFI 1.1
M-6375-K302	 Billet Steel 30 lbs	6.00"	164-tooth	6 bolts	28.2 oz-in	Pre-1981 302 engines and 351 engines using 164T flywheels. 10.5" long, 11" long and diaphragm clutches. Meets SFI 1.1
M-6375-M302	 Billet Steel 30 lbs	6.00"	164-tooth	6 bolts	0 oz-in	All small blocks using 164T flywheels with 0-unbalance rotating assemblies. 10.5" long, 11" long and diaphragm. Meets SFI 1.1
M-6375-N427	 Billet Steel 29 lbs	6.00"	184-tooth	6 bolts	0 oz-in	Fits 1965 and newer 360, 390, 427 FE engines. 11" long and diaphragm, 11.5" and 12" long clutches. Meets SFI 1.1

NOTES: ① Diaphragm clutch uses metric bolts and dowel pins. Requires metric N602549-S51M Pressure Plate Bolts and D1FZ-6397-B Alignment Dowel Pins or M-6397-A302 Ford Performance Kit.







M-6375-D302B



M-6375-A302B

MANUAL TRANSMISSION FLYWHEELS FOR PUSH ROD ENGINES

PART NUMBER		MATERIAL/ WEIGHT	CLUTCH DAMPER ASSEMBLY COUNTER BORE	RING GEAR	CRANK BOLTS	UNBALANCED	APPLICATION
M-6375-D46 ①②		Nodular Iron 21 lbs	6.320"	164-tooth	6 bolts	0 oz-in	4.6L SOHC Mustang with 10.5" clutch. Has increased rpm capacity over stock cast iron flywheel
M-6375-F46A ①②③		Billet Steel 29 lbs	6.00"	164-tooth	6 bolts	0 oz-in	Fits 6-bolt 4.6L Mustang with 10.5" clutch and some 11" clutch applications. Does not fit 2005-2010 Mustang production clutch disc. Meets SFI 1.1
M-6375-G46A ①②③		Billet Steel 29 lbs	6.00"	164-tooth	8 bolts	0 oz-in	Fits 8-bolt 4.6L Mustang with 10.5" clutch and some 11" clutch applications. Does not fit 2005-2010 Mustang production clutch disc. Meets SFI 1.1
M-6375-M50 ①②③		Billet Steel 20 lbs	7.050"	164-tooth	8 bolts	0 oz-in	Fits 8-bolt crank 4.6L and 5.0L Coyote engines with 11" clutch applications. Does not fit 2005-2015 Mustang production clutch disc. Drilled for 6- or 9-bolt pressure plate. Replaces M-6375-G46A. Saves 9 lbs. Meets SFI 1.1
M-6375-R00A ①②③		Aluminum 12 lbs	6.200"	164-tooth	8 bolts	0 oz-in	Fits 8-bolt 4.6L Mustang with 10.5" clutch and some 11" clutch applications with 6-bolt pressure plate. Does not fit 2005-2013 Mustang production clutch disc. Reduced rotating mass. Meets SFI 1.1

NOTES:

- ① Diaphragm clutch uses metric bolts and dowel pins. Requires metric N602549-S51M Pressure Plate Bolts and D1FZ-6397-B Alignment Dowel Pins or M-6397-A302 Ford Performance Kit.
- ② 4.6L engines may have 6 or 8 bolts to attach to the crankshaft. Check the engine code before ordering. Romeo-built engines have 6 bolts and Windsor-built engines have 8 bolts. All Cobra engines have 8 bolts. The 8th character in the VIN is (X) for Windsor engine plant or (W) for Romeo engine plant.
- ③ Requires M-6397-A46 Bolt and Dowel Kit for 11" clutch applications.



M-6375-D46 shown



M-6375-R00A shown

DID YOU KNOW...

1968-1980 302 engines were built with a 28 oz imbalance factor.

1981-2001 302 engines were built with a 50 oz imbalance factor.

1969-1997 351W engines were built with a 28 oz imbalance factor.

1970-1974 351C engines were built with a 28 oz imbalance factor.

NOTE: Severe engine damage will result if you use the wrong flywheel or damper on your engine.

DRIVELINE COMPONENTS (CONTINUED)

1979-2004 MUSTANG V8 HD THROWOUT BEARING
M-7548-A



- Fits 1979-2004 Mustang with manual transmission and V8 engine
- Self-centering bearing design
- Heavy-duty design lasts longer than most aftermarket bearings



WARNING: Cancer www.P65Warnings.ca.gov

ROLLER PILOT BEARING FOR 289/302/351C AND 351W
M-7600-A



- Production roller pilot bearing fits 289, 302, 351C and 351W crankshafts
- Designed for .669 diameter input shaft



NOTE: Pre-greased – do not add extra grease. Clutch and bearing damage may occur.

WARNING: Cancer www.P65Warnings.ca.gov

ROLLER PILOT BEARING 4.6L/5.4L AND 5.0L 4V Ti-VCT MODULAR ENGINES
M-7600-B



- Production roller pilot bearing fits 4.6L/5.4L and 5.0L 4V Ti-VCT modular engines



NOTE: Pre-greased – do not add extra grease. Clutch and bearing damage may occur.

WARNING: Cancer www.P65Warnings.ca.gov

ROLLER PILOT BEARING – HIGH LOAD – 4.6L/5.4L/5.0L4
M-7600-C



- Production roller pilot bearing fits 4.6L/5.4L and 5.0L 4V Ti-VCT modular engines
- Similar to M-7600-B but for higher load applications

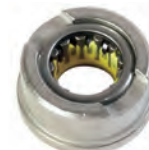

NOTE: Pre-greased – do not add extra grease. Clutch and bearing damage may occur.

WARNING: Cancer www.P65Warnings.ca.gov

CLUTCHES

PART NUMBER	DESCRIPTION	ENGINE	DIAMETER	SPLINE	TECHNICAL INFORMATION
M-7560-A302N ①②③④	HD Clutch Kit	SBF V8	10.5"	1-1/16" x 10 spline	Consists of M-7550-A302N Disc, M-7563-A302N Pressure Plate and D9ZZ-7548-A Throwout Bearing
M-7560-T46 ①	11" Clutch Kit	4.6L DOHC	11"	1-1/8" x 26 spline	Kit contains 11" clutch disc with 26-spline hub and pressure plate. Clutch disc with carbon/copper lining on flywheel side and carbon lining on pressure plate side. Centrifugal assist design pressure plate with 25% more torque capacity than production Cobra. Used when installing M-7003-R58C and M-7003-R58H transmissions into 1996-2004 4.6L Mustang with production 11" flywheel or Ford Performance flywheels M-6375-F46A, M-6375-G46A or M-6375-R00A
M-7550-X302 ①②③	Disc	SBF V8	10.5"	1-1/16" x 10 spline	HD disc with carbon/copper lining on flywheel side and carbon lining on pressure plate side

NOTES:

- Clutches have NO warranty!
- All clutch discs have 1.0625"-10 spline hub.
- Fits all 1986-2001 Mustang GT, 1993-1998 Cobra with T-5 or T-45 transmissions. 2001-2004 Mustang GT with 3650 transmission and 1999-2003 Cobra use an 11" clutch. OK to mix and match Ford Racing clutch discs and pressure plates but do NOT install a FPP pressure plate with a stock disc or vice versa as disengagement problems may occur. Installation of 10.5" clutch assemblies on 1979-1985 vehicles equipped with 10" clutch requires new flywheel (see page 174). Metric fasteners and dowel pins must be used with 10.5" clutches.
- Requires metric N602549-S51M Pressure Plate Bolts and DIFZ-6397-B Alignment Dowel Pins. M-6397-A302 Ford Performance Kit (see page 173).

M-7560-T46 shown

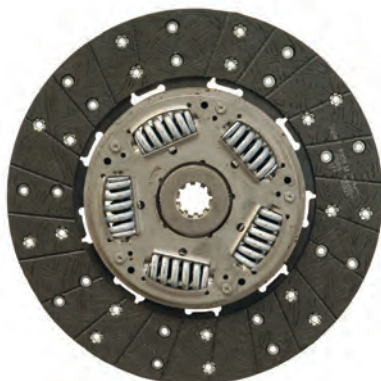

2005-2014 MUSTANG HIGH PERFORMANCE CLUTCH FLUID LINE UPGRADE

M-7512-A

- Service replacement for the following Mustang race cars: FR500C1, FR500C, FR500S, BOSS 302R and BOSS 302S
- Fits 2005-2014 Mustang V-6, GT, BOSS 302 and Shelby GT500 Mustang with manual transmission
- Upgraded clutch fluid line for high temperature, high performance applications
- Replaces factory plastic line
- Stainless steel hard line with braided stainless steel flex hose reduces line expansion
- Includes No. 10 O-rings



1996-2004 MUSTANG CLUTCH RELEASE LEVER

M-7515-A

- Fits 1996-2004 V8 Mustang
- Stock replacement clutch release lever
- Can be used with M-6392-M46 Bellhousing
- Can be used with M-7548-A HD Throwout Bearing



1979-1993 V8 MUSTANG CLUTCH LINKAGE UPGRADE KIT

M-7553-A302

- Fits 1979-1993 Mustang with factory self-adjusting clutch quadrant
- This kit consists of a beefed-up clutch release fork and heavy-duty self adjusting high-lubricity polymer-lined clutch cable
- Can be used with M-7548-A HD Throwout Bearing
- Can be used with M-7554-A Topside Clutch Adjuster and M-7583-A Double Hook Clutch Quadrant



NOTES:

- 1984 and later cars have heavy-duty cable as original equipment
- 1986 and later cars have beefed-up clutch release fork as original equipment
- To install this kit in 1979-1981 vehicles with manual adjustment clutch mechanisms, the 1982 and later self-adjusting quadrant mechanism must be purchased from Ford and Lincoln dealers

V8 MUSTANG ADJUSTABLE CLUTCH LINKAGE KIT

- M-7553-B302 1982-1995 V8 mustang adjustable clutch linkage kit
- M-7553-C302 1982-1995 V8 mustang adjustable clutch service cable
- M-7553-D302 1996-2004 V8 mustang adjustable clutch linkage kit
- M-7553-E302 1996-2004 V8 mustang adjustable clutch cable

- Includes all parts required to convert stock non-adjustable clutch cable to fully-adjustable type
- Now you can adjust clutch pedal travel to your driving habits



1979-2004 V6 AND V8 MUSTANG TOPSIDE CLUTCH ADJUSTER

M-7554-A

- Fits 1979-2004 V6 and V8 Mustang
- Allows you to adjust clutch engagement without going under the car
- Eliminates the rubber bushing at the engine compartment bulkhead for more precise clutch action



1982-2004 V8 MUSTANG DOUBLE-HOOK CLUTCH QUADRANT

M-7583-A

- Fits 1982-2004 V8 Mustang
- Double-Hook design lets you use an adjustable clutch cable or topside clutch adjuster and stock cable
- CNC-machined from billet aluminum



KIT CAR IRS HUB

M-1109-A

- 5 x 4.5" bolt circle, 2.775" wheel pilot hub for popular Mustang size wheels
- Should be used with M-5970-A IRS Knuckle Kit
- Original equipment on 1999-2004 Mustang Cobra

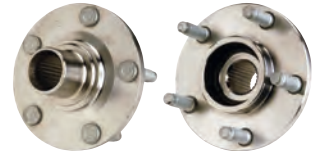

KIT CAR IRS BEARING

M-1215-A

- For use with M-1109-A Kit Car IRS Hub
- Original equipment on 1993-1998 Mark VIII, 1989-1997 Thunderbird and 1999-2004 Cobra



8.8" AXLE GIRDLE COVER KIT

M-4033-G2

- Fits 8.8" axle
- Fits 1986-2004 Mustang GT
- Low profile design also fits 2005-2014 Mustang GT and 2007-2014 Shelby GT500 Mustang except 2013-2014 Track Pack option
- Lightweight 356-T6 aluminum casting replaces rear cover on 8.8"
- Load bolts provide additional support for differential bearing caps
- Increase ring and pinion gear life
- Will not fit IRS; see Part No. M-4033-G33



NOTES:

- Check exterior clearance to chassis/suspension
- Optional differential cooler on 2013-2014 Shelby GT500 requires modifications

DRIVELINE COMPONENTS (CONTINUED)

1999-2004 COBRA IRS AXLE GIRDLE COVER
M-4033-G3

- Fits 1999-2004 Mustang Cobra
- Load bolts provide additional support for differential bearing caps
- Increased ring and pinion gear life
- Fits IRS only
- Does not fit 2015+ Mustang IRS



8.8" ALUMINUM AXLE COVER WITH DIFFERENTIAL COOLER PORTS
M-4033-KA

- Original equipment on 2013-2014 Mustang Shelby GT500 with Track Pack option
- Fits 8.8" Ford rear end, except IRS
- Recommended for road racing or extended high-speed/high-temperature applications to reduce gear oil breakdown, increase gear and bearing life
- Cooling fins help reduce gear oil temperature
- Cover machined for differential cooler pickup and return fittings. 1/2 -14 NPSF dryseal straight pipe threads
- Pipe plugs installed, must be removed to install differential cooler fittings
- Includes 10 hex-head bolts with anaerobic yellow thread locking compound
- Includes 7/16-20 UNF vent plug when used in applications with alternative vent provisions
- Cover machined for temp sensor with M10 X 1.6-6h threads
- Will not fit IRS differential or with differential mounted anti-lock brake exciter ring



1979-2004 MUSTANG 8.8" AXLE INSTALLATION KIT
M-4050-B

- Fits 1979-2004 non-IRS Mustang axle
- Contains two bushings, two C-locks and one 4-ounce bottle of M-19546-A12 Friction Modifier



WARNING: Cancer www.P65Warnings.ca.gov

UNIVERSAL PINION NUT
M-4213-A

- Universal-design 3/4-20 hex flange pinion lock nut
- Fits 6.75", 7.5", 8.8" and 9" axle assemblies
- Flange diameter 1.610"
- 100 per pack



8.8" RING GEAR AND PINION SETS

PART NUMBER	AXLE	RING & PINION
MUSTANG/RANGER/F-150		
M-4209-88308	8.8"	3.08
M-4209-88315	8.8"	3.15
M-4209-88327	8.8"	3.27
M-4209-88331	8.8"	3.31
M-4209-88355	8.8"	3.55
M-4209-88373	8.8"	3.73
M-4209-88410	8.8"	4.10
M-4209-88410F 4X4 FT	8.8"	4.10
M-4209-88456	8.8"	4.56

No one does 8.8" gears better than Ford Performance – stronger and quieter.

The 8.8" rear end has been the standard in performance since its introduction in the Mustang in 1986, and Ford Performance is the manufacturer of choice when it's time to hop-up your axle. Ford Performance recommends our installation kits for all 8.8" ring & pinion gear sets. These installation kits use the highest quality components and are often upgrades to what the vehicle came with.

- Made in the United States at the Ford Sterling Axle Plant (competitors in our price range are primarily produced in China)
- OEM quality – Our superior surface finish, hardening and manufacturing consistency provide the strongest and quietest 8.8" gears in the market! Higher quality gears mean more satisfied customers!
- Race proven – Ford Performance 8.8" gears are the choice of championship road racing and drag racing teams, including Multimatic Motorsports

When you're purchasing a new 8.8" gear set, make sure your bearings and shims are up to the task with a Ford Performance High-Performance Installation Kit!



M-4209-88308 shown

MUSTANG SUPER 8.8" IRS RING GEAR AND PINION SET



PART NUMBER	AXLE	RING & PINION
M-4209-88355A	8.8"	3.55
M-4209-88373A	8.8"	3.73
M-4209-88373B		
M-4209-88409A	8.8"	4.09

- Fits 2015-2018 Mustang Super 8.8" IRS center section
- Includes OEM crush sleeve and pinion nut
- Requires M-4210-B3 Mustang 8.8" ring-gear and pinion install kit
- Made in United States in the Ford Sterling Axle Plant
- OEM quality – our superior surface finish, hardening and manufacturing consistency provides the strongest and quietest gears in the market
- **Requires aftermarket calibration if vehicle is not originally equipped with this gear ratio**

NOTE: 3.15 ratio differential not compatible with 3.31, 3.55, 3.73 and 4.09 ratio gears. Use differential M-4204-MT or M-4204-M

Photo may vary



8.8" 4X4 FRONT 4.10 RING GEAR AND PINION

PART NUMBER	AXLE	RING & PINION
M-4209-88410F (4X4 FT)	8.8"	4.10

- Fits 2004-2017 F-150 4x4 front axle, including these models:
 - Ford Expedition (1997-2014)
 - Ford F-150 1/2 Ton (1997-2017)
 - Ford F-150 Raptor Edition (2010-2014)
 - Ford F-250 3/4 Ton (1997-1999)
 - Lincoln Mark LT (2006-2008)
 - Lincoln Navigator (1998-2014)
- 4.10 8.8" ring and pinion
- OEM quality – superior surface finish, hardening and manufacturing consistency

Kit includes:

- Crush collar
- Pinion nut
- Ring gear bolts
- Pinion bearing
- Pinion seal



2003-2004 COBRA PINION FLANGE M-4851-B



- Fits 8.8" axles, original equipment on 2003-2004 Mustang Cobra and F-150
- <4.250" U-joint flange bolt circle (3.500" U-joint flange bolt circle, use M-4851-C)
- Replaces E9TZ-4851-A



PINION FLANGE 8.8" AXLE M-4851-C

- Fits 8.8" axles except 2003-2004 Mustang Cobra IRS, F-150 and 2005-up Mustang
- 3.500" U-joint flange bolt circle (4.250" U-joint flange bolt circle, use M-4851-B)
- Replaces E9SZ-4851-A



8.8" AXLE BEARING AND SEAL KITS



M-1225-B

- Fits 1986-2004 Mustang
- 8.8" outer axle shaft bearing and seal kit for non-IRS axles



M-1225-B shown

- Kit contains two outer axle shaft bearings and seals
- 2.256" O.D. bearing

WARNING: Cancer www.P65Warnings.ca.gov

M-1225-B1

- Fits 2005-2014 Mustang GT and Mustang GT500
- 8.8" outer axle shaft bearing and seal kit
- Kit contains two outer axle shaft bearings and seals
- 2.5308"/2.5315" bearing O.D.
- 1.6189"/1.6194" bearing I.D.

WARNING: Cancer www.P65Warnings.ca.gov

M-4413-A



- For use in rebuild 8.8" IRS differentials prior to 2015-2019 Mustang. Will not fit 2015-2019 Mustang
- Kit includes two inner stub shaft pilot bearings and two inner stub shaft pilot bearing housing seals



M-4413-A shown

WARNING: Cancer www.P65Warnings.ca.gov

DRIVELINE COMPONENTS (CONTINUED)

8.8" RING & PINION INSTALLATION KIT
M-4210-A



- Fits all 8.8" axles 1986-2014 including IRS
- Perfect for new gear installation in vehicles when new bearings are not required

Kit includes:

- Pinion and carrier shims
- Pinion nut
- Crush sleeve
- Pinion seal
- Ring gear bolts



WARNING: Cancer www.P65Warnings.ca.gov

8.8" RING AND PINION INSTALLATION KIT
M-4210-B2

- Fits all 8.8" axles 1986-2014, including IRS except 2013 BOSS and 2013-2014 GT500
- Excellent upgrade for all 8.8" rear ends
- High-torque bearing adds durability for modified vehicles
- Contains all components from M-4210-A plus all differential bearings

NOTE: Does not fit 2013 BOSS or 2013-2014 GT500 with axle codes S-215-D and S-219-D.

Kit includes:

- 2012 Shelby GT500 high-torque rear pinion bearings
- Pinion and carrier shims
- Heavy-duty carrier bearings
- Gear-marking compound
- Crush sleeve
- Pinion nut
- Pinion seal
- Ring gear bolts
- Cover gasket



WARNING: Cancer www.P65Warnings.ca.gov

7.5" RING GEAR AND PINION INSTALLATION KIT
M-4210-B75

- Fits all 7.5" axles
- Excellent upgrade for all 7.5" rear ends
- High-torque bearing adds durability for modified vehicles

Kit includes:

- 2012 Shelby GT500 high-torque pinion bearing
- Pinion and carrier shims
- Crush sleeve
- Pinion nut
- Pinion seal
- Ring gear bolts
- Heavy-duty carrier bearings
- Gear-marking compound



WARNING: Cancer www.P65Warnings.ca.gov

8.8" RING AND PINION INSTALLATION KIT
M-4210-C3

- Fits all 1986-2004 8.8" axle assemblies except IRS differential
- Contains all components from M-4210-B2 plus M-1225-B 8.8" Axle Bearing and Seal Kit

Kit includes:

- 2012 Shelby GT500 high-torque pinion bearing
- Pinion and carrier shims
- Crush sleeve
- Pinion nut
- Pinion seal
- Ring gear bolts
- Mustang GT carrier bearings
- Gear-marking compound
- Cover gasket



WARNING: Cancer www.P65Warnings.ca.gov

8.8" TRACTION-LOK REBUILD KIT
M-4700-B



- Fits 8.8" Traction-Lok differentials prior to 2015-2016 Mustang. Will not fit 2015-2018 Mustang Super 8.8"

Kit includes:

- Clutch pack
- Shims
- Differential pin lock bolt with thread lock
- Friction modifier CM-19546-A1



WARNING: Cancer www.P65Warnings.ca.gov

8.8" TRACTION-LOK REBUILD KIT WITH CARBON DISCS

M-4700-C

- Fits select 8.8" Traction-Lok differentials – will not fit Super 8.8" differentials
- Carbon fiber discs designed for higher torque usage
- Used in 2003-2004 Cobra and Mustang GT500

Kit includes:

- Carbon fiber clutch pack
- Shims
- 31-spline S-spring, 28-spline applications require use of 28-spline S-spring (not included)
- Differential pin lock bolt with thread lock
- Instruction sheet



WARNING: Cancer www.P65Warnings.ca.gov



FRICTION MODIFIER FOR CLUTCH-TYPE LIMITED-SLIP DIFFERENTIALS

M-19546-A12 Case of 12

CM-19546-A1 Single bottles

- Specially formulated additive to provide smooth operation of clutch-type limited-slip differentials

WARNING: Cancer www.P65Warnings.ca.gov



9.75" F-150 RAPTOR DIFFERENTIAL COVER

M-4033-F975

- Ford Performance branded differential cover
- Fits all F-150 with 9.75" differential
- Rugged powdercoat finish



8.8" TRACTION-LOK LIMITED SLIP DIFFERENTIAL

M-4204-F318C

- 8.8" differential
- Fits 31-spline axles
- Fits solid or independent rear suspension
- Carbon fiber clutch plates for increased durability
- Will accept anti-lock exciter ring
- Requires 4 oz of CM-19546-A1 Friction Modifier with initial fill
- Original equipment in 2003-2004 Mustang Cobra



8.8" FRONT AXLE LIMITED SLIP TORSEN® DIFFERENTIAL M-4204-F150LS

- Fits 2004-2017 F-150 4x4 front axle
- 8.8" Torsen® differential
- 31 spline
- Features full-time torque sensing, torque biasing differential
- Standard on Raptor



2012-2013 MUSTANG BOSS 302 TORSEN® DIFFERENTIAL M-4204-MB

- Fits 2005-2014 Mustang GT and 2007-2014 Shelby GT500 with 8.8" axle and 31 spline
- Fits 8.8" axle with 31 spline
- 8.8" Torsen® differential
- 2.7 drive bias ratio
- 31 spline
- Features full-time torque-sensing, torque-biasing differential
- Standard on 2012-2013 BOSS 302 Mustang Laguna Seca package
- Will accept anti-lock exciter ring
- Does not fit IRS applications



WARNING: Cancer www.P65Warnings.ca.gov

8.8" T-2 TORSEN® DIFFERENTIALS M-4204-T31

- 8.8" differential, fits 31-spline axles
- Torsen® T-2-type differential
- Features full-time torque-sensing, torque-biasing
- Fits solid axle and 2000-2004 Cobra IRS with 31 spline
- M-4204-T28 fits solid axle and 1999 Cobra/Thunderbird/Mark VII with IRS (2000-2004 Cobra has 31 spline)



WARNING: Cancer www.P65Warnings.ca.gov

MUSTANG FR500S DIFFERENTIAL M-4204-T31H

- 8.8" differential
- Fits 31-spline axles
- Torsen® T-2R (Race) type differential with high bias 4.0 ratio
- To achieve the higher bias ratio, the assembly is more complex and designed for race durability
- Service part for the Mustang FR500S race car
- Can be used for performance street or road race applications
- Not for use in drag race applications
- Does not fit IRS applications



WARNING: Cancer www.P65Warnings.ca.gov



DRIVELINE COMPONENTS (CONTINUED)

9" "BENDA" AXLE PINION SEAL

M-4676-A111

- This premium 9" pinion oil seal was developed for high-speed, high-temperature applications
- Developed by Dave Benda, Materials Control Supervisor, Ford Sterling Plant



5-LUG REAR DISC BRAKE KIT – LATE MODEL FORD 9" TRUCK AXLE HOUSING

M-2300-G2

Looking to add some stopping power to the rear of your classic Ford? Tired of searching through junk yards or settling for mismatched rear disc brake parts? This Ford Performance rear disc brake kit includes OE quality calipers, rotors and mounting components.

- Kit includes 11.8" vented rotors, single piston calipers with integral parking brake, custom mounting brackets and attaching hardware
- Rotors feature the common 5-hole, 4.5" diameter passenger car bolt pattern with 2.780" center hub
- Mounting brackets fit the popular 9" late model Ford axle housings with 2" x 3.56" pattern and big 3.15" diameter bearing
- This kit is designed for vehicle installations with a 2.5" brake gap (housing flange-to-axle-shaft flange)
- Includes E-coated caliper mounting brackets, moan braces and dust shields
- Due to large 11.8" diameter rotor and floating caliper design, most production and aftermarket 15" wheels will not fit



NOTE: Wheel spacers not recommended for use with brake kit.

NOTE: Does not fit Mustang 8.8" axle.

NOTE: Hoses, tubes, parking brake cables and wheels are NOT included in this kit. Additional parts and machining may be required. For more information, call the Techline at (800)367-3788.

9" STEEL DIFFERENTIAL CARRIER

M-4141-HS



- Fits 9" Ford rear-end housing
- Developed using finite element analysis (FEA) to withstand the demands of NASCAR® racing
- Steel casting has nearly double the tensile and yield strength and elongation vs. cast iron
- Case investment cast from 8620 steel
- Bearing caps machined from 4130 steel
- ARP® bolts
- 3.250" differential bearing diameter
- Approximate weight: 21 lbs



9" DIFFERENTIAL BEARING ADJUSTER LOCK AND BOLT KIT

M-4144-B



- Includes 2 locks and 2 bolts to secure differential bearing adjusting nuts on 9" nodular carriers produced after November 1989



9" TRAC-LOK LIMITED SLIP DIFFERENTIAL

M-4204-F28A 28 spline

M-4204-F31A 31 spline



- 9" differential
- 4-spring aggressive torque bias
- Street/strip application
- 1536 steel billet case caps
- Cast high-strength nodular iron case
- OEM profile gears made of high-manganese, high-chromium alloy steel
- Rebuildable



BOLT - 9" RING GEAR TO DIFFERENTIAL CASE

M-4216-A200 Sold in pkg. of 100

M-4216-A210 Sold in pkg. of 10



- 7/16"-20 x .9375" bolt
- The most popular 9" ring gear bolt, for use on open differentials, Detroit Lockers and spools



NOTE: Will NOT fit Traction-Lok differentials.

WARNING: Cancer www.P65Warnings.ca.gov

9" "DAYTONA" PINION BEARING RETAINER M-4614-B



- Nodular iron
- Pinion bearing retainer is a direct fit and functional replacement for the C3AZ-4614-B unit, which is no longer serviced by Ford Customer Service Division
- Comes complete with TBAA-4616-A (HM89410) Large Rear Cup and B7A-4614-A (M88010) Small Front Cup



NOTE: Use TBAA-4621-A (HM-89443) Large Rear Bearing and B7A-4621-A (M-88048) Small Front Bearing with these retainers.

HD ALUMINUM DRIVESHAFT ASSEMBLY



M-4602-GA 28 Spline
M-4602-JA 31 Spline

- M-4602-GA fits 1979-1995 Mustang/Capri 5.0L vehicles with T-5/SROD/C-4/AOD, 1979-1993 with Tremec® transmissions and 7.5" or 8.8" axles
- M-4602-JA fits 1996-2004 Mustang and 1996-1998 Cobra 4.6L with manual transmission
- High strength, 3.5" diameter 0.114" wall thickness 6061-RT62 aluminum seamless drawn tube
- 1330 U-joints 45.5" long (CL to CL of U-joints)
- Will not fit 1999-2004 Cobra



ONE-PIECE MUSTANG GT DRIVESHAFT

M-4602-MGTA 1336 mm in length; fits 2005-2010 Mustang GT w/manual transmission
M-4602-MGTM 1430 mm in length; fits 2011-2014 Mustang GT w/auto or manual transmission
M-4602-MSVT 1312 mm in length; fits 2007-2012 Mustang Shelby GT

- Direct bolt-in right out of the box
- Designed for increased horsepower applications to deliver peak endurance and optimum strength
- 3.5" diameter 6061-T6 aluminum tubing with .125" wall thickness provides exceptional strength and reliability
- 1350 SERIES Dana Spicer 5-1350X solid body universal joints...much stronger than the 1330 series versions available for Mustang
- Reduced overall weight and rotating mass delivers improved driving performance and provides quicker acceleration
- Comes with 1350 series flange yoke to bolt to transmission
- Comes with 1350 series flange yoke to bolt to OE Mustang rear end flange...NO adapter required
- Spline and slip design to allow for installation and suspension movement
- Hard plastic boot to keep grease in and water out protects spline and slip from contaminants
- Eliminates the need for a center support bearing
- Fully assembled and balanced
- Off-road use only



M-4602-MSVT shown

BOSS 302R DRIVESHAFT M-4602-S

- Service replacement part for Mustang BOSS 302R race car
- 31-spline yoke
- 1330 U-joints with 4-bolt SN95 flange
- 42" length from centerline of U-joints
- Made from 6061-T6 aluminum, 3.5" diameter x 0.125" wall thickness
- Does not fit production Mustang

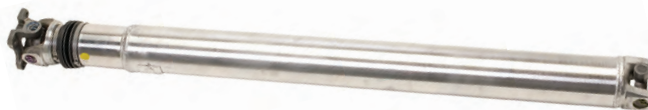

SPECIAL U-JOINT KIT M-4635-A



- Kit consists of a hybrid 1310/1330 series cross, plus (4) 1.0625" OD and (2) 1.125" OD caps and locking clips
- Allows small and large Ford drivetrain components to be interchanged



31-SPLINE DRIVESHAFT YOKE M-4841-A

- Fits 31-spline output shafts
- The splines have an undercut .530" long, with a 1.425" I.D.
- Uses 1330 U-joints
- Use with production T-45, C-6, 3550 and 3650 transmissions
- U-joint cap diameter 1.062"
- U-joint width 3.500"
- Yoke O.D. is 1.685". Machined area length, 6.068"
- Center of U-joint to front of yoke, 7.750" (approx.)

28-SPLINE DRIVESHAFT SLIP YOKE M-4841-B

- For replacement use or custom driveshaft construction
- Fits 28-spline output shafts
- No undercut on splines
- Uses 1330 U-joint
- Fits C-4, AOD and T-5 transmissions
- U-joint cap diameter 1.062"
- U-joint width 3.500"
- Yoke O.D. 1.500". Machined area length, 4.680"
- Center of U-joint to front of yoke, 6.760" (approx.)



M-4841-A shown

DRIVELINE COMPONENTS (CONTINUED)
COBRA JET DRIVESHAFT LOOP
M-5478-CJ

- Service replacement for the Mustang FR500CJ race car
- Meets most drag racing sanctioning body requirements
- Contains driveshaft in the event of front U-joint breakage
- Fits 2005-2009 Mustang with TR6060 transmission
- For use with one-piece driveshafts only

NEW GT4 CV BOOT
M-3A331-GT4A LH
M-3A331-GT4B RH

- Left-hand (LH) and Right-hand side rear CV boots as used on Ford Performance Mustang GT4.
- Designed as an upgrade to the original equipment CV boots, which can be susceptible to tearing during rigorous racing activities.



NOTE: This part is meant for racing and has not been validated for street car usage

NEW 2005-2016 4X4 SUPER DUTY FRONT AXLE KNUCKLE SEAL SHIELD
M-B10677-AA

- Fits 2006-2016 Ford Super Duty® 4x4 model trucks
- Kit includes metal shields to protect the front knuckle seal from dirt or liquid contamination
- Includes 4 metal shields (2 per knuckle) and 8 new nuts

NEW WARN UPGRADED LOCKING HUBS - BLACK
M-1104-SD

The WARN® Premium Locking Hubs for 2005-2019 Super Duty trucks are built with heat treated gears, an all metal cap and dial, and corrosion-resistant stainless-steel hardware. Easy install. Easy turn dial. Easy maintenance.

- Black powdercoated all-metal cap and dial with waterproof IP68 sealing
- Made in the U.S.A. by Warn® Industries, the uncompromising leader in hubs and 4WD technology
- Easy turn dial, even if you're wearing gloves
- Unique cartridge design allows for easier install and disassembly
- Marine-grade stainless-steel hardware resists corrosion and helps keep hubs looking great
- Heat-treated Chromoly steel gears and upgraded bearing housing for greater strength and durability





FORD PERFORMANCE PARTS



MAKE IT OFFICIAL!

WITH **CERTIFICATES OF AUTHENTICITY**

Order your official Certificate of Authenticity today!

800.367.3788

FORDSHOWPARTS.COM

AVAILABLE FOR:

- Taurus SHO
- Mustang BULLITT™
- Mustang GT/CS
- 2005-2006 Ford GT
- 2007-2014 Shelby GT500
- F-150 SVT Raptor
- 1984-1986 Mustang SVO
- 2003-2004 Mustang Mach 1
- 2003-2004 Mercury Marauder
- 1993-2004 SVT vehicles
- MCA Edition Mustang
- 2012-2013 BOSS 302
- Focus ST & RS
- 2015-2018 GT350

AND MORE!

FORD APPEARANCE / DRESS-UP

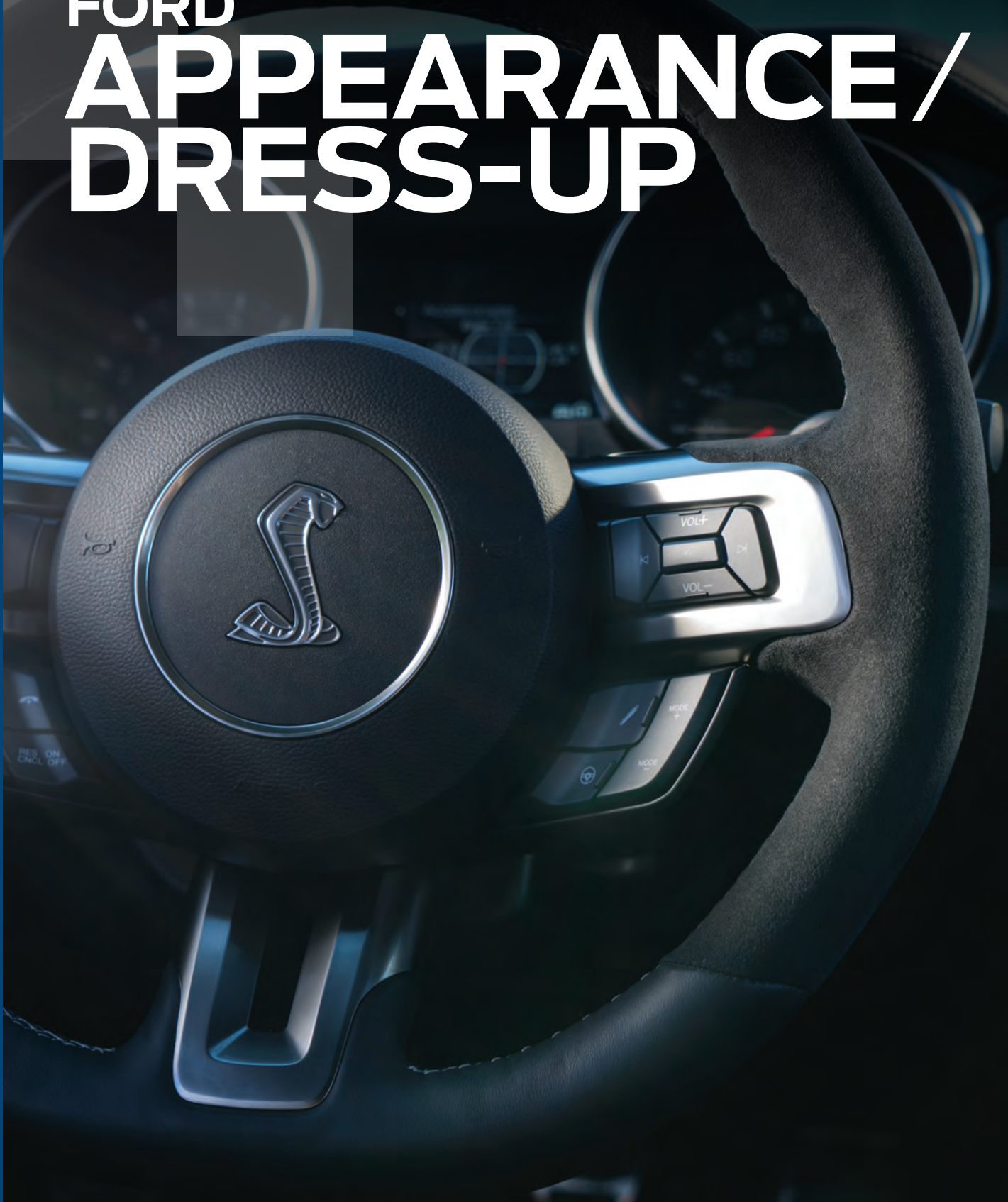

APPEARANCE | DRESS-UP

FORD RACING MUSTANG GAUGE PACK M-6304GPACK-MA

Original equipment on 2012 Mustang BOSS 302 Laguna Seca. Designed for use in 2010-2014 Mustang GT, 2012-2013 Mustang BOSS 302.



- Includes dash-mounted gauge pod and three 2-1/16" gauges
- Oil pressure gauge
- Vehicle performance gauge
- Water temperature gauge
- Includes unique "Ford Racing" adapter plate for easy installation
- Easy installation with included wiring harness and detailed instructions
- Perfect for street and open track use

FORD RACING MUSTANG DASH GAUGE POD M-6304GPOD-A

- Fits 2005-2014 Mustang GT, Shelby GT500 and Mustang V6
- Gauge pod accepts 3 standard 2-1/16" gauges
- Includes dash mounting bracket



2015-2017 MUSTANG PERFORMANCE PACK BOOST GAUGE KIT M-10849-A

- Fits 2015-2017 Mustang GT 5.0L Performance Pack equipped Mustang
- Original equipment on 2015-2017 Performance Pack 2.3L EcoBoost® Mustang
- Kit provides an easy way to read boost levels on Mustang with installed forced induction setup, while maintaining the OEM look and functionality
- Features oil pressure and vacuum/boost gauge
- Easy plug-and-play installation
- Compatible with MyColor® interior lighting

• Installation is plug-and-play and does not require any cutting or splicing

Kit includes:

- Oil pressure/boost gauge
- Trim clips
- Detailed instructions

NOTE: Boost gauge has been validated with Ford Performance, Roush® and Whipple® supercharger kits. Other supercharger kits and aftermarket performance calibrations can prevent boost gauge from functioning.



"FORD RACING" COMPETITION GAUGES



Ford Performance through-the-dial LED competition-style gauges.

These high-quality, full-sweep gauges, available in 2-1/16" diameter, all sport the red and blue "Ford Racing" logo on a black background with white numerals.



M-10883-BFSE
2-1/16" Electric Water Temperature Gauge 100° F-260° F



M-9275-BFSE
2-1/16" Electric Fuel Pressure Gauge 0-100 psi



M-9278-BFSE
2-1/16" Electric Oil Pressure Gauge 0-100 psi

DIGITAL PERFORMANCE INFORMATION CENTER GAUGE M-6304-DPIC

Digital vehicle performance gauge which monitors g-forces, 0-60mph times, 60-0mph distances, 1/4 mile data including reaction time, and peak wheel horsepower.

- 2-1/16 inch
- Meant as a service replacement for 2012 Mustang BOSS 302 Laguna Seca with previously installed harness or M-6304GPACK-MA customers



BLACK SATIN VALVE COVERS M-6582-A



- Fits 289/302/351W (except EFI)
- Black satin finish
- "Cobra Powered by Ford" logo
- May require modifications for roller rockers
- Includes oil fill cap and grommets
- 50-state street legal when installed with appropriate closed PCV hardware



Call the Ford Performance Techline at (800)367-3788

APPEARANCE | DRESS-UP (CONTINUED)
BLACK SATIN VALVE COVER
M-6582-A301R

- Fits 289/302/351W (except EFI)
- Black satin finish
- "Ford Racing" logo
- May require modifications for roller rockers
- Includes oil fill cap and grommets
- Has 1.200" round oil fill/PCV holes
- 50-state street legal when installed with appropriate closed PCV hardware

POLISHED ALUMINUM VALVE COVERS
M-6582-A302R

- Fits 289/302/351W (except EFI)
- Polished finish
- "Ford Racing" logo
- May require modifications for roller rockers
- Includes oil fill cap and grommets
- Has 1.200" round oil fill/PCV holes
- 50-state street legal when installed with appropriate closed PCV hardware

289/302/351W CIRCLE TRACK VALVE COVERS
M-6582-CT2

Circle track valve covers as used on the Ford Racing 347 and 374 sealed racing engines. The breather stacks have been moved to the front of the valve cover for air-box clearance and are welded to the valve cover to ensure against oil leaks. Inside, the breather stack oil control baffle is also welded in place for durability.

- Fits 289/302/351W (except EFI)
- Two 1-3/8" x 3-1/4" breather stacks in the left side valve cover – welded in place
- Includes 2 clamp-on breathers
- Polished die-cast aluminum
- Laser-etched "Ford Racing" logo
- Will clear stud girdle and roller rocker arms (3.880" tall)

BLACK SATIN VALVE COVERS
M-6582-F302

- Fits 289/302/351W (except EFI)
- Black satin finish
- "Cobra" logo (original open letter Cobra)
- May require modifications for roller rockers
- Includes oil fill cap and grommets
- 50-state street legal when installed with appropriate closed PCV hardware

BLACK SATIN VALVE COVERS
M-6582-LE302BK

- Fits 289/302/351W
- Black satin finish
- "Ford Racing" logo
- Will clear stud girdle and roller rocker arms (3.75" tall)
- Includes oil fill cap and grommets
- 50-state street legal when installed with appropriate closed PCV hardware

BLUE SATIN VALVE COVERS
M-6582-LE302BL

- Fits 289/302/351W
- Blue satin finish
- "Ford Racing" logo
- Will clear stud girdle and roller rocker arms (3.75" tall)
- Includes oil fill cap and grommets
- 50-state street legal when installed with appropriate closed PCV hardware

BLACK SATIN VALVE COVERS
M-6582-LE302SBK

- Fits 289/302/351W
- Black satin finish
- Laser-etched "Cobra" snake logo
- Will clear stud girdle and roller rocker arms (3.75" tall)
- Includes oil fill cap and grommets
- 50-state street legal when installed with appropriate closed PCV hardware

FORD RACING 289-351 SLANT EDGE BLACK 302-135

- Fits 289/302/351W
- Satin black finish
- Raised "Ford Racing" logo
- Not designed for use on factory 5.0L EFI intake manifold
- Will clear stud girdle and roller rocker arms (3.35" tall)
- Includes long bolts for center upper bolt hole (1 per valve cover)

FORD RACING 289-351 SLANT EDGE BLACK STEALTH 302-135B

- Fits 289/302/351W
- Satin, all-black "Stealth" finish
- Raised "Ford Racing" logo
- Not designed for use on factory 5.0L EFI intake manifold
- Will clear stud girdle and roller rocker arms (3.35" tall)
- Includes long bolts for center upper bolt hole (1 per valve cover)



FORD RACING 289-351 SLANT EDGE BLUE 302-136

- Fits 289/302/351W
- Ford Blue finish
- Raised "Ford Racing" logo
- Not designed for use on factory 5.0L EFI intake manifold
- Will clear stud girdle and roller rocker arms (3.35" tall)
- Includes long bolts for center upper bolt hole (1 per valve cover)



FORD RACING 289-351 SLANT EDGE GRAY 302-137

- Fits 289/302/351W
- Gray crinkle finish
- Raised "Ford Racing" logo
- Not designed for use on factory 5.0L EFI intake manifold
- Will clear stud girdle and roller rocker arms (3.35" tall)
- Includes long bolts for center upper bolt hole (1 per valve cover)



FORD RACING 289-351 SLANT EDGE POLISHED 302-138

- Fits 289/302/351W
- Polished aluminum finish
- Recessed "Ford Racing" logo
- Not designed for use on factory 5.0L EFI intake manifold
- Will clear stud girdle and roller rocker arms (3.35" tall)
- Includes long bolts for center upper bolt hole (1 per valve cover)



FORD RACING 289-351 SLANT EDGE CHROME 302-139

- Fits 289/302/351W
- Chrome finish
- Recessed "Ford Racing" logo
- Not designed for use on factory 5.0L EFI intake manifold
- Will clear stud girdle and roller rocker arms (3.35" tall)
- Includes long bolts for center upper bolt hole (1 per valve cover)



BLACK SATIN VALVE COVERS M-6582-B301

- Fits 289/302/351W (except EFI)
- Black satin finish
- "Mustang Powered By Ford" logo
- May require modifications for roller rockers
- Has 1.200" round oil fill/PCV holes



BLACK SATIN SMALL BLOCK 427 VALVE COVERS M-6582-W427B

- Fits 289/302/351W (except EFI)
- Pentroof 427 style, used on Ford Racing SB 427 crate engines
- Black satin finish
- "427 Cobra" logo
- May require modifications for roller rockers
- Valve covers are not compatible with M-6584-A50 Gasket, Fel-Pro® VS 13264T recommended



BLACK SATIN VALVE COVERS M-6000-C302

- Fits 1986-1993 EFI Mustang
- Black satin finish
- "Cobra" logo (original open letter Cobra)
- May require modifications for roller rockers
- 50-state street legal



POLISHED ALUMINUM VALVE COVERS M-6000-D302

- Fits 1986-1993 EFI Mustang
- Polished finish
- "Cobra" logo (original open letter Cobra)
- May require modifications for roller rockers
- 50-state street legal



BLACK SATIN VALVE COVERS M-6000-E302

- Fits 1986-1993 EFI Mustang
- Black satin finish
- "Mustang Powered By Ford" logo
- May require modifications for roller rockers
- 50-state street legal



POLISHED ALUMINUM VALVE COVERS - MUSTANG LOGO M-6000-F302

- Fits 1986-1993 EFI Mustang
- Polished finish
- "Mustang" logo
- May require modifications for roller rockers
- 50-state street legal



APPEARANCE | DRESS-UP (CONTINUED)
BLACK SATIN VALVE COVERS
M-6000-J302R

- Fits 1986-1993 EFI Mustang
- Black satin finish
- "Ford Racing" logo
- May require modifications for roller rockers
- 50-state street legal

BLACK SATIN TRUCK VALVE COVERS
M-6582-A351R

- Fits 302 and 351W EFI trucks
- Black satin finish
- "Ford Racing" logo
- May require modifications for roller rockers
- 50-state street legal

POLISHED ALUMINUM VALVE COVERS
M-6582-Z351

- Fits 1969-1970 BOSS 302/351C/351M/400
- Polished finish
- "Ford Racing" logo
- Will clear stud girdle and roller rocker arms (4" tall)
- Includes grommets

CLEVELAND BLACK ALUMINUM VALVE COVERS
M-6582-Z351B

- Fits 1969-1970 BOSS 302/351C/351M/400
- Satin finish
- "Ford Racing" logo accent in red
- Will clear stud girdle and roller rocker arms (4" tall)
- Includes grommets

BLACK SATIN VALVE COVERS
M-6582-A341R

- Fits 302 BOSS/351C/351M/400
- Black satin finish
- "Ford Racing" logo
- May require modifications for roller rockers

POLISHED ALUMINUM VALVE COVERS
M-6582-A342R

- Fits 1969-1970 BOSS 302/351C/351M/400
- Polished finish
- "Ford Racing" logo
- May require modifications for roller rockers

POLISHED ALUMINUM VALVE COVERS
M-6582-A427

- Fits 352/360/390/427/428
- Polished finish
- "Cobra Le Mans" logo
- May require modifications for roller rockers
- Has 1.200" round oil fill/PCV holes

BLACK SATIN VALVE COVERS
M-6582-B

- Fits 352/360/390/427/428
- Black satin finish
- "Cobra Le Mans" logo
- May require modifications for roller rockers
- Has 1.200" round oil fill/PCV holes

460 ALUMINUM VALVE COVERS SATIN BLACK
M-6582-B460

- Fits 429/460
- Satin black finish
- "Ford Performance" logo
- Will clear stud girdle and roller rocker arms (5.75" tall)

BLACK SATIN VALVE COVERS
M-6582-C351BK

- Fits 1969-1970 BOSS 302/351C/351M/400
- Black satin finish
- "351 CLEVELAND" logo
- May require modifications for roller rockers



POLISHED ALUMINUM VALVE COVERS M-6582-C351PD



- Fits 1969-1970 BOSS 302/351C/351M/400
- Polished finish
- "351 CLEVELAND" logo
- May require modifications for roller rockers



POLISHED ALUMINUM VALVE COVERS M-6582-C460

- Fits 429/460
- Polished finish
- "Ford Racing" logo
- Will clear stud girdle and roller rocker arms (4.5" tall)



289-302-351W SB FORD RACING BLACK RIBBED ALUMINUM VALVE COVERS M-6582-W351PR

- Fits 289/302/351W (except EFI)
- Pentroof 427 style 4.500" tall
- Used on Ford Racing SB X302E/B, Z363FT/RT and Z427AFT/RT crate engines
- Black satin finish
- "Ford Racing" logo
- May require modifications for roller rockers
- Valve covers are not compatible with M-6584-A50 Gasket; Fel-Pro® VS 13264T recommended



SLANT EDGE "FORD RACING" AIR CLEANER 302-999

- Cast gray crinkle finish matches the Ford Performance Parts 302-137 Valve Cover
- Uses genuine 3" Motorcraft® air filter elements (Part No. FA612R) for maximum airflow
- The air cleaner lid attaches to a short stud that is screwed into the center of the carburetor
- Lid has a threaded boss on the underside, and is simply spun into place by the installer
- Each kit is supplied with necessary mounting hardware



COBRA INTAKE PLAQUE

M-1447-D46 1996-1998 – 4" tall x 2.25" wide
M-1447-F46 1999-2001 – 3.4" tall x 2.25" wide



- Cobra intake plaque from Cobra upper intake manifold
- Designed in the shape of the Cobra snake
- High-quality embossed Cobra snake
- Blue inlay on brushed aluminum background
- Two-way tape for easy installation



BREATHER CAP WITH "FORD RACING" LOGO



M-6766-FRNVBK Black Powdercoated
M-6766-FRNVBL Blue Powdercoated
M-6766-FRNVCH Chrome

- Fits most 289/302/351W Ford Racing valve covers
- Laser-etched "Ford Racing" logo
- Push-in type
- Open crankcase design

M-6766-FRNVBL shown



BREATHER CAP WITH "FORD RACING" LOGO – CLOSED CRANK DESIGN



M-6766-FRVBK – Black Powdercoat
M-6766-FRVBL – Blue Powdercoat
M-6766-FRVCH - Chrome

- Black or blue powdercoat or chrome finish with laser etched Ford Racing logo
- Push-in type
- Closed crankcase design
- Fits most 289/302/351W Ford Racing valve covers

⚠ WARNING: Cancer www.P65Warnings.ca.gov



M-6766-FRVBK shown

CHROMED ALUMINUM OIL FILL CAP COVER FOR 4.6L/5.4L/6.8L



M-6766-MP46A

- Fits all years of modular engine
- Installs over factory plastic oil fill cap (not included)
- Features "Ford Racing" logo painted in blue and red
- Clearcoated



UNIVERSAL VALVE COVER BREATHER CAP GROMMETS M-6892-F



- Kit includes one grommet for push-in breather cap and one for a PCV valve
- Grommets fit all Ford Performance valve covers for push rod engines
- Grommets designed for 1.200" hole
- Also converts twist-in breather valve cover to push-in style breather



OVAL AIR CLEANER ASSEMBLIES

M-9600-C302 "Cobra" Logo
M-9600-K302 "Mustang" Logo

- For single 4V carburetors
- Die-cast aluminum lid with stamped steel base
- Black satin finish
- Assembly height is 2.5"
- Includes mounting hardware



⚠ WARNING: Cancer www.P65Warnings.ca.gov

APPEARANCE | DRESS-UP (CONTINUED)
CHROME IGNITION COIL BRACKET
M-12044-A2

- Universal fit for canister style ignition coil
- Chrome plated steel

WARNING: Cancer www.P65Warnings.ca.gov



DISTRIBUTOR HOLD-DOWN CLAMP
M-12270-A302

- 2.3L HSC, V6 and V8 except FE

WARNING: Cancer www.P65Warnings.ca.gov

CUSTOM BILLET WIRE LOOMS
M-12297-L900

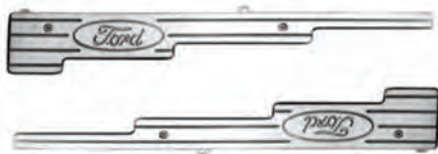
- Ford Oval billet aluminum spark plug wire looms with ball milled logos
- Fits 8 mm and 9 mm wire
- Keeps all wires neat and away from headers
- Adjustable brackets fit all big and small block engines except FE V8
- Use with universal spark plug wires



WARNING: Cancer www.P65Warnings.ca.gov

HOOD LATCH AND PIN KIT
M-16700-A

- That competition look you've always wanted
- This is similar to the original hood pin kit used on early Mustang and Fairlane
- Can be used with most original and aftermarket hoods
- This part is not designed to fit the 2005 and newer Mustang



WARNING: Cancer www.P65Warnings.ca.gov

COBRA JET AND FR500S HOOD PIN KIT
M-16700-S

- Service replacement part for the 2010 Cobra Jet and FR500S Mustang race cars
- Includes one pair of plated hood pins with two-piece clasps

MUSTANG SVT "COBRA" SNAKE FENDER EMBLEMS

M-1447-C 4.25" tall x 2.50" wide

Original equipment on 2007-2009 Shelby Mustang GT500.

M-1447-SR 2.875" tall x 1.700" wide

Original equipment on 1994-2004 Mustang SVT Cobra.

- Includes right- and left-side emblems
- Two-way tape for easy installation
- Injection molded plastic
- Chrome finish

M-1447-C shown
2011-2014 MUSTANG 5.0L FENDER EMBLEM
M-1447-M50

- Original equipment on 2011-2014 Mustang GT
- Includes right- and left-side emblems
- Two-way tape for easy installation
- Injection molded plastic
- Chrome finish

2015-2019 MUSTANG 5.0L FENDER EMBLEM
M-1447-M50A Chrome

M-1447-M50AB Black

- Original equipment on 2015-2019 Mustang GT
- Includes right- and left-side emblems
- Two-way tape for easy installation
- Injection molded plastic

SVT DECKLID EMBLEM
M-1447-SVT

- Original equipment on Mustang SVT Cobra and Contour SVT
- Similar to SVT emblem used on Focus SVT
- Two-way tape for easy installation
- Injection molded plastic
- Chrome finish

COBRA JET GRILLE EMBLEM
M-16098-CJG

- Inspired by the Ford Performance FR500CJ Cobra Jet Mustang
- Laser-cut metal snake with flames, painted red, white and blue
- Complete with two studs for mounting
- Can be affixed to grille or kept as a keepsake
- Approximately 3" tall x 4.5" wide



“FORD PERFORMANCE” FENDER COVER M-1822-A7

- Protect that beautiful paint job from scratches, chemicals and oil with this strong, sturdy and slip-resistant “Ford Performance” fender cover
- Measures 27" x 36" and is acid/grease resistant
- Features handy “ridged” area in which to place small tools and parts



“FORD PERFORMANCE” TRACK MAT M-1822-A8

- 2' x 4' folding mat
- Includes “Ford Performance” logo
- 100% polypropylene fibers
- 3/4" closed cell foam
- Impact absorbing cushion
- Water and stain resistant



CHROME V8 BADGE M-7843-V8

- Vintage style V8 logo
- Two-way tape for easy installation
- 2.5" tall x 1.5" wide
- Injection molded plastic
- Chrome finish



2015 - 2019 MUSTANG “FORD PERFORMANCE” DASH EMBLEM M-1447-A

Fits 2015-2019 Mustang

- As used by the Ford Performance Team on Factory-built race cars like the FP350S
- Installs using attached 2-sided tape on the passenger side dash in place of the standard “Mustang” dash emblem



ECOBOOST® EMBLEMS/BADGES – BLACK AND SILVER – PAIR M-1447-EBBLK

- Black and silver EcoBoost® emblem/badge
- 3-1/2" long x 9/16" wide – Qty 2
- Complement any EcoBoost®-powered hot rod, street rod or vehicle
- Can be attached on engine covers, doors, fenders, hatches, hoods, etc.
- Automotive-grade double-sided tape included on back of emblem



ECOBOOST® EMBLEMS/BADGES – BLACK AND CHROME – LARGE SIZE – PAIR M-1447-EBBLKG

- Black and chrome EcoBoost® emblem/badge
- Large size – 5-11/16" long x 13/16" wide – Qty 2
- Complement any EcoBoost®-powered hot rod, street rod or vehicle
- Can be attached on engine covers, doors, fenders, hatches, hoods, etc.
- Automotive-grade double-sided tape included on back of emblem



“POWERED BY FORD PERFORMANCE” BADGE M-16098-PBFP

- “Powered by Ford Performance” classic fender badge
- 5-5/8" long x 1-5/8" high – Qty 2
- Chrome-plated 3-dimensional nameplate with red, black and blue accents
- Self-adhesive backing designed for application on flat surfaces



“FORD PERFORMANCE” TIRE SHADE M-1822-A9

Ford Performance tire shade blocks the sun's hot rays from your rear tires and keeps them cool for more consistent pressures at the track.

- 42" x 36"
- Safely attaches to body panels via five heavy-duty suction cups
- Made of durable white vinyl with screen printed “Ford Performance” logo
- Fits over most wheel opening sizes



“FORD PERFORMANCE” LICENSE PLATE – SINGLE M-1828-FPONE

- This license plate has a “Ford Performance” logo on white background
- Sold individually



APPEARANCE | DRESS-UP (CONTINUED)
STAINLESS STEEL "FORD PERFORMANCE" LICENSE PLATE FRAME
 M-1828-SS304C

- Dress up your vehicle with this high-quality license plate frame
- Brushed 304 stainless steel with black laser-etched "Ford Performance" logo
- For the same license plate frame in a black finish, see M-1828-SS304BK

BLACK STAINLESS STEEL "FORD PERFORMANCE" LICENSE PLATE FRAME
 M-1828-SS304BK

- Dress up your vehicle with this high-quality license plate frame
- Constructed from 304 stainless steel with black finish and laser etched "Ford Performance" logo
- This license plate frame will complement any Ford Performance fan's vehicle
- For the same license plate frame in stainless steel finish, see M-1828-SS304C

NEW LICENSE PLATE FRAME
 M-1828-SSB

This high quality license plate frame has a slim design that allows you to dress up your vehicle without covering the state designation and registration tags on your license plate!



- Constructed from 304 stainless steel, with black powdercoat finish and laser etched "Ford Performance" logo
- This license plate frame will complement any Ford Performance fan's vehicle
- For the same license plate frame in stainless steel finish, see M-1828-SSC

NEW LICENSE PLATE FRAME
 M-1828-SSC

- This high quality license plate frame has a slim design that allows you to dress up your vehicle without covering the state designation and registration tags on your license plate!
- Constructed from 304 stainless steel, with brushed stainless steel finish and laser etched "Ford Performance" logo
- This license plate frame will complement any Ford Performance fan's vehicle
- For the same license plate frame in black finish, see M-1828-SSB

"FORD PERFORMANCE" DECAL - 10 PACK
 M-1820-FP

- 10" x 4"
- "Ford Performance" decals with white background, adhesive backing
- Pkg. of 10

"FORD PERFORMANCE" BANNER - 5' WIDE X 3' HIGH
 M-1827-FP

- Multipurpose banners ideal for races, car shows, car clubs, promotions, garage or man cave
- White background with blue and red lettering on heavy gauge plastic
- Includes grommets at attachment points

"FORD RACING" 50' PENNANT STRING

 M-1827-P1 Ford Racing
 M-1827-P2 Ford Performance

- Pennant string
- 50' long
- String of rectangular and pennant flags
- Great for any race track, car show, or gearhead's garage

NEW FORD PERFORMANCE 5.0 SMART BATTERY CHARGER & MAINTAINER
 M-10300-FP

The Ford Performance 5.0 charger/maintainer safely charges and maintains your battery assuring high reliability and longer life. The 5.0 charger/maintainer provides a fully automatic, microprocessor controlled, eight step charge approach that takes your battery through a reconditioning process and safely maintains it through extended storage periods. Today's high performance, high technology vehicles demand a high performance charger/maintainer. The Ford Performance 5.0 is one of the fastest, most effective consumer charger available.

Features Include:

- Charges Batteries up to 110AH and maintains batteries up to 160AH.
- Unique Desulfation reconditioning mode for extending life
- Built-in ambient temperature sensing for optimum charging
- AGM and EFB battery charging capability to include all 12V lead-acid batteries
- 8 step charging program
- Selectable for smaller powersport batteries
- IP 65 splash and dust resistant
- Spark Proof and reverse polarity protected for ultimate safety
- True "plug and play" operation. Connect it and forget it.
- Significantly extends the useful life of your battery.
- Optional Rubber Bumper for protection: M-10300-COVER



NEW BUMPER COVER – FORD PERFORMANCE 5.0 BATTERY CHARGER AND MAINTAINER
M-10300-COVER

Rubber Bumper Cover for Ford Performance 5.0 Battery Charger and Maintainer (part number M-10300-FP)

- Helps protect battery charger and vehicle surfaces from damage
- Provides a slip resistant finish for the battery charger
- Installs in seconds – no tools required



FORD GT BATTERY CHARGER KIT

- M-10665-A US Specification
- M-10665-B UK Specification
- M-10665-C EU Specification

Fits 2017-2019 Ford GT North American models.

This is the same battery charger that's included with the Ford GT.

This 7.0 amp charger is designed to be used with Ford GT Lithium battery only.

- Includes alligator style clamp charging adaptor for all model year Ford GTs (powerpoint plug for MY19 Ford GTs sold separately)
- Comes with the soft stowage bag, rubber bumper and manual as used with the Ford GT



E-Z UP® INSTANT SHELTERS

	SIZE
M-1827-T10A	10' X 10'
M-1827-T20A	10' X 20'

"Ford Performance" E-Z UP® Instant Shelter®

Includes:

Top, frame and cover bag; blue with white logo.

- E-Z Up® portable shelters are available in 2 sizes
- White "Ford Performance" logo over blue top
- White, powdercoated, rust-resistant steel frame with blue commercial grade 500 denier polyester top
- Patented, elevated center design for increased headroom
- Reinforced trusses with aircraft strength fasteners
- Improved Auto-Peak® and Auto-Slider® offer smoother setup
- Telescoping legs lock into place using the new toggle lock and release system
- Cover bag included
- Sent directly from the manufacturer, please allow 2-3 weeks for delivery



"FORD PERFORMANCE" E-Z UP® TENT SIDE WALLS - 10'

PART NUMBER	SIZE
M-1827-W10A	10' Sidewall

- 10' side wall
- Two 10' sidewalls are required to cover a 20' section
- Blue with white logo
- Drop-shipped from the manufacturer
- Non-stocked, built to order item. Allow 2 or more weeks for delivery
- Order from any Ford Performance dealer. Special order, no returns

NEW FORD PERFORMANCE OFF ROAD/TRACK AIR COMPRESSOR KIT
M-1830-FPAC

The Ford Performance by ARB High Output Air Compressor has been constructed entirely of lightweight, high-grade materials with a class-leading flow rate, this compressor has been designed for flat tire inflation and a range of other functions whether they be for work or play. This portable kit includes a 19-foot air hose, battery clamps, inflation kit, and a durable carrying case.



Additional Features:

- Sealed for moisture and dust resistance
- Hard-anodized cylinder bore for reduced friction
- Teflon-impregnated carbon fiber piston seal for maximum trouble-free life
- Quality components for quiet operation and extra-long life
- Constructed entirely of lightweight, high-strength engineering-grade materials
- Over-pressure safety valve equipped
- Motor is internally thermal protected against extreme temperature damage
- Heavy-duty MAXI fuse equipped for professional in-line circuit protection



Ford Engine Dress-up Parts

Valve Covers, Air Cleaners and Breather Caps to Personalize Your Engine

Complete your engine style with Slant-Edge Engine Dress-up Parts, and show your Ford loyalty with this new, aggressive and stylish look for your engine. Five matching finishes, and four emblem configurations to choose from, will give your engine bay a unique look that's all your own. This look even goes well with valve covers or air cleaners from another set! Check it out today at FactorySpeedParts.com!

Five Finishes and Four Emblem Configurations Available!



Finish	Emblem Style	Valve Cover Part Number*	Breather Cap** Part Number	Air Cleaner Part Number
Ford Blue	Raised/Milled Emblem	302-136 [†]	302-436 [†]	302-381 [†]
Black Crinkle	Raised/Milled Emblem	302-135 [†]	302-435 [†]	302-380 [†]
Gray Crinkle	Raised/Milled Emblem	302-137 [†]	302-437 [†]	302-382 [†]
Chrome	Recessed Black Emblem	302-139 [†]	302-439 [†]	302-384 [†]
Polished	Recessed Black Emblem	302-138 [†]	302-438 [†]	302-383 [†]
Black Crinkle	Mustang Raised Emblem	302-140 [†]	n/a	n/a
Black Crinkle	Recessed Red Emblem	n/a	302-440 [†]	302-385 [†]

*Also Available w/ Ford Racing Raised/Milled Emblem in Green, White, Red, Yellow, and Powdercoat Ready Finishes
**Also Available w/o Emblem in Polished

Some items may not be legal for sale or use in California or on any pollution controlled vehicle.

Slant-Edge Valve Covers

Breather Grommet Included: Yes
Material: Die-Cast Aluminum
Bolt Pattern: Perimeter Bolt
Height: Tall
Baffled: Yes



Slant-Edge Breather Cap

Air Breather Style: Push-in
Material: Die-Cast Aluminum
Diameter: 2.25-in.
Hood: Without Hood



Slant-Edge Air Cleaner Attaches with Threaded Boss on Bottom Side

Slant-Edge Air Cleaner

Diameter: 13-in.
Material: Die-Cast Aluminum
Filter: Included
Height: 3.75-in.
Net Height: 3.25-in.



www.factoryspeedparts.com

Products with [†] symbol have the following warning:



WARNING:
Cancer and Reproductive Harm
-www.P65Warnings.ca.gov



FORD ACCESSORIES / APPAREL



MUSTANG

HOOD LOUVERS*

VJR3Z-16C630-C Matte Black

VJR3Z-16C630-D Gloss Black

Fits 2018-2020 Mustang.

Personalize your Mustang with these hood louvers.

- Available in Matte or Gloss black finish, ready to install
- Can be painted to match or complement your car's finish
- Faux honeycomb grilles add to the look
- Precision manufacturing processes provide precise fit and finish
- UV-resistant finishes help keep things looking good for years to come
- Easy to install or have your Dealer's trained technicians provide installation service



VJR3Z-16C630-C shown

PARKING LAMP CURTAINS*

VJR3Z-17E810-B Gloss Black

VJR3Z-17E810-A Matte Black

Fits 2018-2020 Mustang.

Up the intensity factor with these front-end accents that are sure to differentiate your Mustang from the rest.

- Precision manufacturing processes provide precise fit and finish
- Advanced materials technology contribute to premium products with excellent durability
- UV-resistant finishes help keep things looking good for years to come
- Easy to install or have your Dealer's trained technicians provide installation service



VJR3Z-17E810-A shown

QUARTER WINDOW LOUVERS*

VJR3Z-63280B10-A Matte Black

Fits 2018-2020 Mustang.

Trick out your Pony with slotted old-school-cool louvers, featuring faux honeycomb grilles.

- These stylish louvers were designed by Ford to complement the Mustang's styling
- Precision manufacturing processes provide precise fit and finish
- Easy to install or have your Dealer's trained technicians provide installation service
- Also available pre-painted in most Mustang colors



SIDE SCOOPS*

VJR3Z-63279D36-A Matte Black

Fits 2018-2020 Mustang.

Developed specifically for the Mustang, these scoop kits add a personalized, custom appearance. The faux honeycomb grilles add to the muscular look.

- Precision manufacturing processes provide precise fit and finish
- Rugged polyurethane construction
- Easy to install or have your Dealer's trained technicians provide installation service
- Also available pre-painted in most Mustang colors



* Indicates Ford Licensed Accessory

ACCESSORIES AND APPAREL (CONTINUED)

PERFORMANCE PACK SPOILER, COUPE ONLY

JR3Z-6344210-AB

Fits 2018-2020 Mustang.

Add a racing-inspired, aero-designed accent to the tail of your vehicle.

- Designed by Ford engineers
- Precision manufacturing processes provide precise fit and finish
- Easy to install or have your Dealer's trained technicians provide installation service
- Painting required for the Performance Pack Spoiler
- Other styles available – see your local Ford dealer for details



REAR BUMPER DIFFUSER, MATTE BLACK*

VJR3Z-17F828-A

Fits 2018-2020 Mustang.

Our rear diffuser's performance-inspired styling complements the vehicle's original design DNA providing an integrated look.

- Replace your Mustang's rear lower fascia with this diffuser-style fascia
- Precision manufacturing processes provide precise fit and finish
- UV-resistant finishes help keep things looking good for years to come
- Easy to install or have your Dealer's trained technicians provide installation service



GRAPHICS KIT – SPEED STRIPE*

VFR3Z-6320000-D Gloss White
VFR3Z-6320000-C Matte Black

Fits 2015-2020 Mustang.

Personalize your new car with a Stripe Package designed specifically for the 2015 Mustang.

- 3M High Performance Graphic Film
- Tested to withstand the elements
- Designed for ease of installation
- Many styles available, see your local Ford Dealer for details



VFR3Z-6320000-D shown

FULL VEHICLE COVER – NOAH STYLE

FR3Z-19A412-D - Convertible
FR3Z-19A412-B - Coupe

Fits 2015-2020 Mustang.

Protect your Mustang with a full vehicle cover.

- Constructed of multi-layer, non-woven, breathable material, NOAH covers resist rain, snow, acid rain and bird droppings, and protect your vehicle finish from UV rays and door dings
- Double-stitched overlapped seams; elastic sewn into the front and rear hems help hold cover in place
- Non-scratch grommets can be used with a tie-down rope (included) or a cable and lock (not included)



FR3Z-19A412-B shown

FULL VEHICLE COVER – WEATHERSHIELD STYLE

- FR3Z-19A412-E Shelby GT-350
- FR3Z-19A412-F Shelby GT-350 with Raised Rear Spoiler
- VKR3Z-19A412-C California Special Coupe*
- VKR3Z-19A412-B California Special Convertible*
- VKR3Z-19A412-A Mustang BULLITT™**
- VKR3Z-19A412-A Mustang Coupe*
- VKR3Z-19A412-C Mustang Convertible*

Fits 2015-2020 Mustang.

Protect your Mustang with a full vehicle cover.

- WeatherShield fabric features the Nextec encapsulation process for excellent protection and compact storage
- Covers resist rain, snow, acid rain and bird droppings, and protect your vehicle's finish from UV rays
- Silk-screened logos



FR3Z-19A412-E shown

WHEEL LOCKS – CHROME PLATED FOR EXPOSED LUGS GR3Z-1A043-A

Fits 2015-2020 Mustang.

Help prevent wheel and tire theft on your vehicle with these good-looking, chrome-plated Wheel Locks. Use them to replace one lug nut on each wheel as a welcome measure of security for your vehicle.

- Chrome-plated locks available to replace exposed lugs
- Zinc-plated locks are available to replace hidden lugs
- Kit includes 4 locks and a key



SPARE TIRE KIT – MINI, FOR V6, I4 AND GT FR3Z-1K007-C

Fits 2015-2020 Mustang.

Fortify your Mustang V6, I4 and GT coupe or convertible with this kit that's sized just right for stay-put storage in the covered trunk well.

- 18 x 5.0 aluminum wheel – includes tire and valve stem
- Scissor jack
- Wrench attached to jack during storage
- Retainer bracket with bolt and washer
- Easy to install; no drilling required



SUNSCREEN – UVS100 CUSTOM* VJR3Z-78519A02-A

Fits 2015-2020 Mustang.

Park your vehicle outside? A UVS100® Custom Sunscreen from Ford Licensed Accessories can help reduce the temperature inside the vehicle and help protect the interior from damaging UV rays.

- Custom fit to your vehicle
- Reflective outer layer
- Helps shade steering wheel and seats
- Helps reduce fading of interior
- Features model-specific logo



FLOOR LINER – ALL-WEATHER TRAY STYLE, 4-PIECE, BLACK, WITH PONY LOGO HR3Z-6313300-AA

Fits 2015-2020 Mustang.

The deep grooves and raised ridges in these heavy-duty mats catch and hold snow, slush and mud, while protecting the vehicle carpeting.

- Nibbed backing and driver-side positive retention help keep mats in place
- Dual Retention on driver and passenger side



* Indicates Ford Licensed Accessory

ACCESSORIES AND APPAREL (CONTINUED)

DASHCAMS*

- VHL3Z-19G490-C Forward-Facing Dashcam Only
- VHL3Z-19G490-D Dashcam with Rear-Facing Camera Bundle
- VHL3Z-19G490-E Dashcam with Infrared Interior-Facing Camera Bundle

Fits 2019-2020 Mustang.

These compact Dashcams can capture your next trip in full HD 1080p video that you can view on your PC or Mac OS computer.

- Full 140 degree forward viewing angle helps you capture the whole scene
- Wide dynamic range helps provide correct exposure and contrast
- In low-light conditions, videos are recorded with minimal noise and correct exposure
- Motion detector and impact sensor trigger the camera to record when in Parking Surveillance Mode – camera provides an alert at next power-up letting you know an incident occurred
- Energy Saving Mode helps provide extended parking surveillance duration
- Configure dashcam settings with easy to use software



VHL3Z-19G490-D, Dashcam with Rear-Facing Camera Bundle shown

DOOR SILL PLATES – ILLUMINATED

FR3Z-63132A08-AA

Fits 2015-2020 Mustang.

Add a touch of class to your Mustang with these illuminated door sill plates.

- These brushed-stainless steel sill plates emit an LED glow, spelling out MUSTANG
- They shut off automatically when the doors close
- Kit includes two sill plates
- Dealer installation recommended



RANGER

BEDLINER – SPORTLINER*

VKB3Z-9900038-A 5' Bed
VKB3Z-9900038-B 6' Bed

Fits 2019-2020 Ranger.

Get the look of carpet in a tough 100% polypropylene bedliner.

- Padded liner is knee-friendly and fits like a glove
- Weather-, chemical-, skid- and fade-resistant
- Includes tailgate liner



TONNEAU/BED COVER – EMBARK, RETRACTABLE WITH CHANNELS FOR BED RACKS*

VKB3Z-99501A42-E 5' Bed
VKB3Z-99501A42-F 6' Bed

Fits 2019-2020 Ranger.

These manually retractable bed covers use a sealed ball-bearing roller system for easy one-handed operation. They are key lockable in any position along the rail providing excellent flexibility. Integrated track system adds versatility by allowing the use of t-slot racks from Yakima and Thule providing the ability to mount bike carriers, baskets and other gear above the cover. (Racks and carriers available at extra cost.)

- Heavy-duty aluminum construction
- Spiral track system keeps cover from coming in contact with itself as it rolls into the compact storage container
- Attractive low-profile design
- Convenient pop-up handle – no need for straps
- Durable matte-black finish with Ford Oval badge
- Easy to install, no drilling required



TONNEAU/BED COVER – HARD FOLDING, LOW PROFILE, BETWEEN BED RAIL DESIGN*

VKB3Z-99501A42-C 5' Bed
VKB3Z-99501A42-D 6' Bed

Fits 2019-2020 Ranger.

The sleek, “no profile” design makes this a favorite. This folding bed/tonneau cover mounts flush with the side of the truck bed.

- Provides 100% access to stake pockets and works with tie-downs, bed rails, bed extenders and bedliners
- Made from rigid, heavy-duty 3/4” thick panels strong enough to hold up to 300 lbs. (evenly distributed)
- Rugged synthetic hinges and seals provide outstanding weather resistance
- Lock the cover in full open position with the included prop rods for access to the whole bed without removing the cover
- Hidden, quick-release latch system automatically locks panels when shut, simply lock the tailgate to secure the bed



TONNEAU/BED COVER – HARD ROLLING, LOW PROFILE, BETWEEN BED RAIL DESIGN*

VKB3Z-99501A42-G 5' Bed
VKB3Z-99501A42-H 6' Bed

Fits 2019-2020 Ranger.

Provides the convenience of a roll-up bed cover. Between the rails design provides full access to the stake pockets for other accessories.

- Provides 100% access to the bed when rolled up
- Compact design maximizes visibility through the rear window
- Top-mounted buckle straps secure rolled bundle in open position
- Locking rail design secures the cover the full length of the bed when closed
- Rugged, leather-grained vinyl covering provides a classic tonneau/bed cover look
- Easy, clamp-on, no drill installation



* Indicates Ford Licensed Accessory

ACCESSORIES AND APPAREL (CONTINUED)

TONNEAU/BED COVER – SOFT FOLDING, OVER BED RAIL DESIGN*

- VKB3Z-99501A42-A 5' Bed
- VKB3Z-99501A42-B 6' Bed

Fits 2019-2020 Ranger.

These soft folding covers feature a durable vinyl covering and come completely assembled for easy installation.

- Tri-fold design allows full access to the truck bed. The heavy-duty straps and snaps allow cover to be fully open and secured at the cab while driving
- Double pivot hinges with center link and padded seals are engineered to last
- Steel corner brackets and I-beam bows team up to provide a strong frame
- Premium grade seals help keep the weather out without affecting the vehicle finish
- Glass filled, spring-loaded, nylon speed clamps help keep the cover secure



TONNEAU/BED COVER - SOFT XLP PREMIUM ROLL-UP*

- VKB3Z-99501A42-L 5' Bed
- VKB3Z-99501A42-M 6' Bed

Fits 2019-2020 Ranger.

This premium roll-up cover mounts between the rails to provide access to stake pockets for compatibility with other accessories.

- Sleek low-profile appearance
- Fully automatic tension control helps keep the cover taut in hot or cold weather
- Inside the rail mounting allows full access to stake pockets
- Easy one-finger release latch
- Free-floating hook and loop system moves on the rail and works with the tension control system to keep the cover tight



DASHCAMS*

- VHL3Z-19G490-C Forward-Facing Dashcam Only
- VHL3Z-19G490-D Dashcam with Rear-Facing Camera Bundle
- VHL3Z-19G490-E Dashcam with Infrared Interior-Facing Camera Bundle

Fits 2019-2020 Ranger.

These compact Dashcams can capture your next trip in full HD 1080p video that you can view on your PC or Mac OS computer.

- Full 140 degree forward viewing angle helps you capture the whole scene
- Wide dynamic range helps provide correct exposure and contrast
- In low-light conditions, videos are recorded with minimal noise and correct exposure
- Motion detector and impact sensor trigger the camera to record when in Parking Surveillance Mode – camera provides an alert at next power-up letting you know an incident occurred
- Energy Saving Mode helps provide extended parking surveillance duration
- Configure dashcam settings with easy to use software



VHL3Z-19G490-D, Dashcam with Rear-Facing Camera Bundle shown

TAILGATE LETTERING*

- VKB3Z-9942528-B Black Platinum Stainless Steel
- VKB3Z-9942528-A Polished Stainless Steel

Fits 2019-2020 Ranger.

Available in Polished Stainless Steel and Black Platinum Stainless Steel finishes.

- Fits perfectly inside the factory lettering channels
- Simple peel and stick installation



VKB3Z-9942528-B shown

SPLASH GUARDS - GATORBACK, WITH RANGER SCRIPT*

VKB3Z-16A550-C Rear Pair
VKB3Z-16A550-A Front Pair

Fits 2019-2020 Ranger.

Rugged design and custom quality finish helps protect against mud and debris.

- Ford-exclusive kits feature pre-punched holes and all hardware required for installation
- No measuring required, simply assemble and install



BOLT-ON LOOK FENDER FLARES*

VKB3Z-16268-C SuperCab
VKB3Z-16268-A SuperCrew

Fits 2019-2020 Ranger.

These big, bold and brash flares finished in matte-black have the bolted-on look that says "in your face," but in reality, requires no drilling for installation.

- Each flare adds 1-1/2" of tire coverage
- Made of thick, warp-resistant DuraFlex® 2000 ABS for durability
- Textured, matte-black finish is not meant for paint
- Edge trim and hex-head "bolts" are pre-assembled at the factory for easy installation
- No metal to metal contact helps minimize the chances for corrosion
- Other styles available, see your local Ford dealer



HOOD PROTECTOR - AEROSKIN*

VKB3Z-16C900-B Black Textured
VKB3Z-16C900-A Smoke
VKB3Z-16C900-C Chrome
VKB3Z-16C900-D AeroSkin II - Black Textured

Fits 2019-2020 Ranger.

Protects the leading edge of the hood from airborne debris.

- Precision engineered to affix directly to the hood surface
- Textured, acrylic construction
- Several styles available, see your local Ford Dealer



VKB3Z-16C900-B shown

SIDE WINDOW DEFLECTORS - SMOKE*

VKB3Z-18246-A SuperCab
VKB3Z-18246-B SuperCrew

Fits 2019-2020 Ranger.

Deflectors keep out the weather so you can crack open the window and let fresh air in.

- Durable, smoke-colored acrylic
- Self-stick adhesive for easy installation



MATTE BLACK GRAPHICS KITS*

VKB3Z-6320000-B Speed Stripes for SuperCab (shown)
VKB3Z-6320000-C Sport Stripes
VKB3Z-6320000-A Hood Cowl Stripe

Fits 2019-2020 Ranger.

Custom graphics are a great way to customize nearly any vehicle. You can now personalize your new truck with a graphics kit that accentuates the lines of your new truck.

- Made from 3M high performance graphic film
- Matte black stripes
- Designed to last in even the most extreme conditions
- Easy to install



VEHICLE SAFE BY CONSOLE VAULT*

VKB3Z-9906202-A (shown)
VKB3Z-9906202-B Floor Mount under SuperCrew Rear Seat

Fits 2019-2020 Ranger.

Provides peace of mind for those with high security needs. Our in-vehicle safes discreetly mount in the console or under the rear seat.

- 4-digit combination lock with 10,000 possible combinations (Combination lock is CADOJ compliant)
- Constructed of 12 gauge cold rolled plate steel with welded tab and notch seams
- 3-point locking system resists prying
- Spring assisted lid



* Indicates Ford Licensed Accessory

**ACCESSORIES AND APPAREL (CONTINUED)****FLOOR LINERS**

KB3Z-2113300-AA SuperCab
 KB3Z-2613300-AA Crew Cab

Fits 2019-2020 Ranger.

Helps provide maximum protection from spills, dirt and grime. These premium Floor Liners help collect the mess so your carpeting doesn't have to!

- Constructed of durable, pliable molded Thermoplastic Elastomer (TPE) for long life
- Maximum traction, wet or dry
- Easy to clean, simply remove from vehicle and wash with soapy water
- 4-piece kit for front and rear, Black

**WHEELS – 18" BLACK, MACHINE FACED, SET OF 4
KB3Z-1K007-C**

Fits 2019-2020 Ranger.

Designed and engineered to complement the new Ranger's athletic appearance.

- Tested to original equipment standards for corrosion resistance
- Set of 4, includes lug nuts
- Includes TPMS sensor and Wheel Center Caps



F-150

BED RAILS – CHROME WITH CHROME END CAPS*

- VFL3Z-9955200-A 5.5' Bed
- VFL3Z-9955200-B 6.5' Bed

Fits 2015-2020 F-150.

These high-quality Bed Rails provide useful functionality as tie down anchors and add an attractive touch of style to your F-150.

- Constructed of highly polished chrome, 1-3/4" T-304 stainless steel tubing
- The zinc die-cast ends feature chrome plating
- Corrosion-resistant mounting hardware for long life
- 5-1/2' beds require trimming of the plastic bed cap to access the front stake pockets - the Installation Kit (VFL3Z-99000A25-A) allows technicians to make a neat cut for a finished look
- Other styles available, see your Ford dealer



TONNEAU/BED COVER – EMBARK, RETRACTABLE WITH CHANNELS FOR BED RACKS*

- VJL3Z-84501A42-A 5.5' Bed
- VJL3Z-99501A42-A 6.5' Bed
- VJL3Z-99501A42-B 8' Bed

Fits 2015-2020 F-150.

These manually retractable bed covers use a sealed ball-bearing roller system for easy one-handed operation. They are key lockable in any position along the rail providing excellent flexibility. Integrated track system adds versatility by allowing the use of t-slot racks from Yakima and Thule providing the ability to mount bike carriers, baskets and other gear above the cover.

- Heavy-duty aluminum construction
- Spiral track system keeps cover from coming in contact with itself as it rolls into the compact storage container
- Attractive low-profile design
- Convenient pop-up handle – no need for straps
- Durable matte-black finish with Ford Oval badge
- Easy to install, no drilling required



TONNEAU/BED COVER – HARD FOLDING, LOW PROFILE, BETWEEN BED RAIL DESIGN*

- VFL3Z-84501A42-CA 5.5' Bed
- VFL3Z-99501A42-CA 6.5' Bed
- VFL3Z-99501A42-DB 8' Bed

Fits 2015-2020 F-150.

The sleek, "no profile" design makes this a favorite. This folding bed/tonneau cover mounts flush with the side of the truck bed.

- Provides 100% access to stake pockets and works with tie-downs, bed rails, bed extenders and bedliners
- Made from rigid, heavy-duty 3/4" thick panels strong enough to hold up to 300 lbs. (evenly distributed)
- Rugged synthetic hinges and seals provide outstanding weather resistance
- Lock the cover in full open position with the included prop rods for access to the whole bed without removing the cover
- Hidden, quick-release latch system automatically locks panels when shut, simply lock the tailgate to secure the bed



TONNEAU/BED COVER – HARD ROLLING, LOW PROFILE, BETWEEN BED RAIL DESIGN*

- VGL3Z-84501A42-BA 5.5' Bed
- VGL3Z-99501A42-CA 6.5' Bed
- VGL3Z-99501A42-DB 8' Bed

Fits 2015-2020 F-150.

Provides the convenience of a roll-up bed cover. Between the rails design provides full access to the stake pockets for other accessories.

- Provides 100% access to the bed when rolled up
- Compact design maximizes visibility through the rear window
- Top-mounted buckle straps secure rolled bundle in open position
- Locking rail design secures the cover the full length of the bed when closed
- Rugged, leather-grained vinyl covering provides a classic tonneau/bed cover look
- Easy, clamp-on, no drill installation



* Indicates Ford Licensed Accessory

F-150 ACCESSORIES (CONTINUED)

TONNEAU/BED COVER – SOFT FOLDING, OVER BED RAIL DESIGN*

- VGL3Z-84501A42-AA 5.5' Bed
- VGL3Z-99501A42-BA 6.5' Bed
- VGL3Z-99501A42-AA 8' Bed

Fits 2015-2020 F-150.

These soft folding covers feature a durable vinyl covering and come completely assembled for easy installation.

- Tri-fold design allows full access to the truck bed. The heavy-duty straps and snaps allow cover to be fully open and secured at the cab while driving
- Double pivot hinges with center link and padded seals are engineered to last
- Steel corner brackets and I-beam bows team up to provide a strong frame
- Premium grade seals help keep the weather out without affecting the vehicle finish
- Glass filled, spring-loaded, nylon speed clamps help keep the cover secure



TONNEAU/BED COVER – PREMIUM SOFT ROLL-UP*

- VJL3Z-84501A42-B 5.5' Bed
- VJL3Z-99501A42-C 6.5' Bed
- VJL3Z-99501A42-D 8' Bed

Fits 2015-2020 F-150.

This premium roll-up cover mounts between the rails to provide access to stake pockets for compatibility with other accessories.

- Sleek low-profile appearance
- Fully automatic tension control helps keep the cover taut in hot or cold weather
- Inside the rail mounting allows full access to stake pockets
- Easy one-finger release latch
- Free-floating hook and loop system moves on the rail and works with the tension control system to keep the cover tight



DASHCAMS*

- VHL3Z-19G490-C Forward-Facing Dashcam Only
- VHL3Z-19G490-D Dashcam with Rear-Facing Camera Bundle
- VHL3Z-19G490-E Dashcam with Infrared Interior-Facing Camera Bundle

Fits 2019-2020 F-150.

These compact Dashcams can capture your next trip in full HD 1080p video that you can view on your PC or Mac OS computer.

- Full 140 degree forward viewing angle helps you capture the whole scene
- Wide dynamic range helps provide correct exposure and contrast
- In low-light conditions, videos are recorded with minimal noise and correct exposure
- Motion detector and impact sensor trigger the camera to record when in Parking Surveillance Mode – camera provides an alert at next power-up letting you know an incident occurred
- Energy Saving Mode helps provide extended parking surveillance duration
- Configure dashcam settings with easy to use software



VHL3Z-19G490-D, Dashcam with Rear-Facing Camera Bundle shown

TAILGATE LETTERING*

- VJL3Z-9942528-B Black Platinum Stainless Steel
- VJL3Z-9942528-A Polished Stainless Steel

Fits 2018-2020 F-150.

Available in Polished Stainless Steel and Black Platinum Stainless Steel finishes.

- Fits perfectly inside the factory "F-150" lettering channels
- Simple peel and stick installation
- A new kit (VHC3Z-9942528-A) for Platinum Trim F-150 is available that fills in the "Platinum" tailgate lettering with attractive gunmetal colored lettering



VJL3Z-9942528-A shown

SPLASH GUARDS – GATORBACK, WITH F-150 LOGO*

VHL3Z-16A550-H Rear Pair
VHL3Z-16A550-A Front Pair

Fits 2015-2020 F-150.

Rugged design and custom quality finish helps protect against mud and debris.

- Ford-exclusive kits feature pre-punched holes and all hardware required for installation
- No measuring required, simply assemble and install
- Many other designs available for F-150, see your local Ford dealer



BOLT-ON LOOK FENDER FLARES*

VFL3Z-16268-A For 2015-2017 F-150
VJL3Z-16268-A For 2018-2020 F-150

Fits 2015-2020 F-150.

These big, bold and brash flares finished in matte-black have the bolted-on look that says "in your face," but in reality, requires no drilling for installation.

- Each flare adds 1-1/2" of tire coverage
- Made of thick, warp-resistant DuraFlex® 2000 ABS for durability
- Textured, matte-black finish is not meant for paint
- Edge trim and hex-head "bolts" are pre-assembled at the factory for easy installation
- No metal to metal contact helps minimize the chances for corrosion
- Other styles available, see your local Ford dealer



DOOR MOLDING - MATTE BLACK*

VJL3Z-1820049-A SuperCrew
VJL3Z-1820049-B SuperCab

Fits 2015-2019 F-150.

Designed to enhance your truck's styling and help protect against debris and mud while traversing the trickiest terrains and weather conditions.

- Impact-resistant yet very light weight
- No Drill Application
- Easy Installation



HOOD SCOOP – SATIN BLACK*

VJL3Z-16C630-A

Fits 2015-2020 F-150.

Customize your F-150 with a precision fitted hood scoop designed to complement the style of your new truck.

- Add a performance look to your truck
- Satin black finish
- Honeycomb grilles
- No painting or drilling required



TAILGATE SPOILER – SATIN BLACK*

VJL3Z-9944210-B

Fits 2015-2020 F-150.

Performance-inspired styling complements the vehicle's original design DNA providing an integrated look.

- Precision manufacturing processes help provide precise fit and finish
- UV-resistant finish to help keep things looking good for years to come
- For vehicles with conventional tailgate (no tailgate step)
- Not for use with Tonneau/Bed Covers



ROOF SPOILER – SATIN BLACK*

VJL3Z-9944210-A

Fits 2015-2020 F-150.

Add instant style to your truck with a cab spoiler.

- Constructed from lightweight polyurethane
- Ready to install or paint to match
- Installs easily, no drilling



* Indicates Ford Licensed Accessory

ACCESSORIES AND APPAREL (CONTINUED)

TAILGATE TRIM PANEL – SATIN BLACK*

VJL3Z-99425A34-A

Fits 2018-2020 F-150

Customize your F-150 with this precision fitted tailgate trim panel designed to complement the style of your new truck.

- Satin black finish
- Precision manufacturing processes help provide precise fit and finish
- UV-resistant finish to help keep things looking good for years to come
- No painting or drilling required



HOOD PROTECTORS – AEROSKIN*

VGL3Z-16C900-A Smoke

VHL3Z-16C900-A Smoke for 2017-2020 Raptor Models

VJL3Z-16C900-A AeroSkin II – Black Textured (shown)

Fits 2015-2020 F-150

Protects the leading edge of the hood from airborne debris.

- Precision engineered to affix directly to the hood surface
- Textured, acrylic construction
- Several styles available, see your local Ford dealer



SIDE WINDOW DEFLECTORS – SMOKE*

VGL3Z-18246-F Regular Cab, 2-piece kit

VGL3Z-18246-B SuperCab, 4-piece kit (shown)

VGL3Z-18246-G SuperCrew

Fits 2015-2020 F-150

Deflectors keep out the weather so you can crack open the window and let fresh air in.

- Durable, smoke-colored acrylic
- Self-stick adhesive for easy installation
- Several styles available, see your local Ford dealer



VEHICLE SAFE BY CONSOLE VAULT*

VFL3Z-2806202-A (shown)

VFL3Z-2806202-B For 40/20/40 front seats – armrest mounted

VFL3Z-2806202-C For 40/20/40 front seats – seat cushion mounted

Fits 2015-2020 F-150

Provides peace of mind for those with high security needs. Our in-vehicle safes discreetly mount in the console or under the rear seat.

- 4-digit combination lock with 10,000 possible combinations (Combination lock is CADOJ compliant)
- Constructed of 12 gauge cold rolled plate steel with welded tab and notch seams
- 3-point locking system resists prying
- Spring assisted lid



VFL3Z-2806202-A shown

FLOOR LINERS

HL3Z-1513086-AA Regular Cab, 2-piece

HL3Z-1613300-AA Crew Cab, 3-piece

HL3Z-1813300-AA SuperCab, 3-piece

Fits 2015-2020 F-150

Helps provide maximum protection from spills, dirt and grime. These premium Floor Liners help collect the mess so your carpeting doesn't have to!

- Constructed of durable, pliable molded Thermoplastic Elastomer (TPE) for long life
- Maximum traction, wet or dry
- Easy to clean, simply remove from vehicle and wash with soapy water



FORD PERFORMANCE MERCHANDISE

FORD PERFORMANCE WATER BOTTLE WITH WIRELESS SPEAKER

1439956

Tritan™ bottle with Bluetooth® speaker in lid. LED ring flashes while music plays. Call microphone, carabiner lid, micro USB cord, IP66 dust/water resistance, and 3-4 hours' play time.

- Size: 24 oz.
- Color: Red



FORD PERFORMANCE ALUMINUM SPORT BOTTLE

1439957

BPA-free recyclable matte aluminum, rubber grip, and loop lid. Hand wash only; do not microwave.

- Size: 25 oz.
- Color: Black/Red



FORD PERFORMANCE TOPTEMP TUMBLER

1438864

Copper-lined, vacuum-insulated stainless steel; tapered body; and screw-on acrylic lid. 8 hours hot/16 hours cold.

- Size: 20 oz.
- Color: Black/Red



FORD PERFORMANCE VELOCITY MESH CAP

1439603

Fabric front, mesh back, and adjustable plastic snap closure.

- Color: Red/White/Blue



FORD PERFORMANCE PRO STYLE MESH CAP

1436779

Structured chino twill front, mesh back, weathered finish, and Velcro® closure.

- Color: Blue



FORD PERFORMANCE FLAT BILL CARBON FIBER CAP

1439604

Chino Twill/Mesh back, flat bill visor, structured, plastic closure, chino twill sweatband.

- Color: Black



FORD PERFORMANCE OGIO® X-OVER CAP

1416610

Unstructured, low-profile peak; moisture-wicking polyester; branded OGIO® details/visor trim; and adjustable antique pewter buckle closure.

- Color: Black



Take 20% OFF your first order of Ford Performance Merchandise. Use Promo Code: **FORDPERFORMANCE**
Offer expires 12/31/2020 *Some restrictions may apply



ACCESSORIES AND APPAREL (CONTINUED)

FORD PERFORMANCE BEANIE

1438748

Acrylic knit fabric with woven label logo.

- Color: Black

**FORD PERFORMANCE COUNTER STOOL**

1429547

Retro 50s styling with single foot ring; padded, 360° swiveling seat; nylon floor glides; and steel frame. This item ships directly from the manufacturer; please allow 4-6 weeks for delivery.

- Size: 30" H.
- Color: Black

**FORD PERFORMANCE DUO POLO**

1438867

Moisture-wicking micro-mesh polyester; contrast sleeves, shoulders, and collar; and three-button placket.

- Size: M - 2XL
- Color: Black/Dark Gray

**FORD PERFORMANCE HEATHERED POLO**

1438866

Moisture-wicking, anti-microbial, and UV/snag-resistant peached micropolyester; heathered finish; two-button placket, and partial ribbed cuffs.

- Size: M - 2XL
- Color: Black/Smoke

**FORD PERFORMANCE OGIO® TRAX POLO**

1428746

Double-mesh performance polyester; contrast insets at sides, shoulders, sleeves, and 3-button hidden placket; and open hem sleeves.

- Size: M - 2XL
- Color: Black/Gray



Ford Merchandise Store (consumers): shopfordmerchandise.com
 Ford Oval Outlet (dealers): fordovaloutlet.com Customer Service: 1.800.351.7631

FORD PERFORMANCE NIKE POLO

1429236

Stay cool when things heat up. Engineered with Dri-FIT fabric which provides moisture management technology. This comfortable micro pique polo has an exceptionally soft hand. The design features a flat knit collar, three-button placket, open hem sleeves. Made of 4.4-ounce, 100% polyester.

- Size: M - 2XL
- Color: Black



FORD PERFORMANCE WICKING QUARTER-ZIP PULLOVER

1432911

Moisture-wicking stretch poly, UPF 30 sunscreen, and quarter-zip placket.

- Size: M - 2XL
- Color: Black



FORD PERFORMANCE OGIO® SOFT SHELL JACKET

1429238

100% poly stretch shell that is wind and water resistant. Waterproof center front zipper, articulated shaping for ease of movement, zip-through collar, set-in sleeves with shaped cuffs and slight drop tail hem.

- Size: M - 2XL
- Color: Black



FORD PERFORMANCE HYDRATION PACK

1439955

Nylon/ripstop fabric, 2-liter PEVA bladder and bite-valve tube, double-hooked bladder compartment with extra storage, organization panel, zip front pocket, 2 mesh holsters, shoulder/sternum straps, and padded back.

- Size: 10.5" x 17" x 4.5"
- Color: Black



FORD PERFORMANCE OUTLANDER CAMP CHAIR

1431788

Folding polyester chair with steel frame, cup holder, removable 9-can cooler, headrest pocket, and carry bag. 400 lb. capacity.

- Color: Black



Take 20% OFF your first order of Ford Performance Merchandise. Use Promo Code: FORDPERFORMANCE

Offer expires 12/31/2020 *Some restrictions may apply





DEALER LISTING

CODES:

LS = LOCAL SALES
MO = MAIL ORDER
EB = ENGINE BUILDER
IN = INSTALLATION
WH = WHOLESALE

ALABAMA

**ASSOCIATE JOBBERS
WHSE/ NPW**
 BOAZ, AL 35957
 256-593-2289
WH

THE PARTS HOUSE
 DOTHAN, AL 36301
 334-836-9800
IN, WH

ARIZONA

AMP PERFORMANCE
 PHOENIX, AZ 85034
 602-437-2727
LS, MO, EB, IN, WH

CALIFORNIA

AUTOCARS/SPEEDSHOP DIRECT
 ATASCADERO, CA 93422
 877-773-3329
LS, MO, WH

DENBESTE MOTORSPORTS
 WINDSOR, CA 95492
 707-836-1534
LS, MO, EB

GALPIN AUTO SPORTS
 VAN NUYS, CA 91406
 818-922-3800

HILLBANK MOTOR SPORTS
 IRVINE, CA 92618
 888-445-5226
LS, MO, IN, WH

MODULAR MOTORSPORTS
 CAMARILLO, CA 93012
 805-383-4130
EB, WH

MOTOR WAREHOUSE
 SACRAMENTO, CA 95815
 916-920-2221
WH

MOUNTUNE
 CARSON, CA 90745
 714-424-9400

**MUSCLE MOTORS
DISTRIBUTION**
 ESCONDIDO, CA 92029
 844-466-7347
LS, MO, EB, IN, WH

NPW – SPEED WAREHOUSE
 SAN JOSE, CA 33764
 408-453-2171
WH

RANDYS RING & PINION
 FRESNO, CA 93725
 800-347-1188
LS, MO, IN, WH

**SPEED WAREHOUSE INC./ CMA
WAREHOUSE**
 GARDENA, CA 90248
 323-318-7070
WH

TEAM C, INC.
 BELLFLOWER, CA 90706
 562-866-3887

TURNKEY ENGINE SUPPLY
 OCEANSIDE, CA 92056
 760-966-2663
LS, EB

WEST COAST DIFFERENTIALS
 RANCHO CORDOVA, CA 95742
 800-642-0950
WH

FLORIDA

ICONIC PARTS
 BOYNTON BEACH, FL 33426
 561-752-3693
LS, MO, IN, WH

LETHAL PERFORMANCE INC
 WELLINGTON, FL 33414
 561-753-8105
LS, MO, WH

**NATIONAL AUTO PARTS
WAREHOUSE**
 MIAMI, FL 33155
 305-263-8220
WH

**NATIONAL PERFORMANCE
WAREHOUSE**
 CLEARWATER, FL 33764
 727-531-8497
WH

**NATIONAL PERFORMANCE
WHSE MIAMI**
 MIAMI, FL 33167
 305-953-7270
WH

POWERED BY FORD
 ORLANDO, FL 32805
 407-843-3673
LS, MO, EB, IN, WH

REVOLOGY CARS LLC
 ORLANDO, FL 32810
 407-757-2725

STEEDA AUTOSPORTS
 POMPANO BEACH, FL 33069
 954-960-0774
LS, MO, IN, WH

THE PARTS HOUSE
 OPA-LOCKA, FL 33054
 866-874-2229
IN, WH

THE PARTS HOUSE
 JACKSONVILLE, FL 32256
 866-874-2229
IN, WH

THE PARTS HOUSE
 ORLANDO, FL 32808
 866-874-2229
IN, WH

THE PARTS HOUSE
 PINELLAS PARK, FL 33773
 866-874-2229
IN, WH

THE PARTS HOUSE
 TALLAHASSEE, FL 32304
 850-575-2000
IN, WH

GEORGIA

BARNETT PERFORMANCE
 ATLANTA, GA 30312
 800-533-1320
LS, MO, WH

JON KAASE RACING, INC.
 WINDER, GA 30680
 770-307-0241

STEEDA AUTOSPORTS
 VALDOSTA, GA 31601
 229-249-8151
LS, MO, IN, WH

SUMMIT RACING EQUIPMENT
 MCDONOUGH, GA 30253
 800-230-3030
LS, MO, WH

IDAHO

NPW / TIME DISTRIBUTING
 BOISE, ID 83714
 208-342-6868
WH

RESTORATION RODS, LLC
 GARDEN CITY, ID 83714
 208-853-5411

ILLINOIS

D.S.S. COMPETITION ENGINES
 ST. CHARLES, IL 60174
 630-587-1169
LS, MO, EB, WH

WINNER'S CIRCLE
 PEORIA, IL 61603
 309-688-9165
LS, MO, EB, IN, WH

WINNER'S CIRCLE
 EAST MOLINE, IL 61244
 309-755-2277
LS, MO, EB, IN, WH

**WINNER'S CIRCLE SPEED
AND CUSTOM**
 JOLIET, IL 60431
 815-727-6331
LS, MO, EB, IN, WH

INDIANA

BRENSPEED
 PIERCETON, IN 46562
 574-594-9559
LS, MO, EB, IN, WH

THE TIRE RACK
 SOUTH BEND, IN 46628-8422
 888-541-1777
MO

KENTUCKY

CORNETT RACING ENGINES
 SOMERSET, KY 42501
 606-678-2226
LS, MO, EB

MASSACHUSETTS

FORTE PARTS CONNECTION
 FRAMINGHAM, MA 1702
 508-875-0016
LS, MO, EB, IN, WH

FACTORY FIVE RACING
 WAREHAM, MA 02571
 508-291-3443
LS, MO

MICHIGAN

CAPALDI DEVELOPMENT, INC.
 CHESTERFIELD, MI 48047
 586-949-RACE
LS, MO, IN, WH

**DIVERSIFIED PRODUCTS
MARKETING, INC.**
 PLYMOUTH, MI 48170
 734-459-0130
MO, WH

DTS/DRIVE TRAIN SPECIALISTS
 WARREN, MI 48089
 800-521-0628
LS, MO, IN

HOLBROOK RACING ENGINES
 LIVONIA, MI 48150
 734-762-4315
LS, EB, IN

KINETIC RACING ENGINES
 WESTLAND, MI 48185
 734-595-7593
EB

KOHR MOTORSPORTS
 WESTLAND, MI 48185
 734-306-6032

LIVERNOIS MOTORSPORTS

DEARBORN, MI 48125
313-561-5500
LS, MO, EB, IN, WH

MOTOR STATE DISTRIBUTING

WATERVLIET, MI 49098
269-463-4113
WH

ROUSH PERFORMANCE

LIVONIA, MI 48150
800-59-ROUSH

TOTAL PERFORMANCE

CLINTON TOWNSHIP, MI
48036-1108
586-468-3673
LS, MO, EB, IN, WH

WATSON RACING

BROWNSTOWN TWP., MI 48193
734-759-0555
LS, MO, IN, WH

MINNESOTA**PARTS MIDWEST, INC.**

MOUNDS VIEW, MN 55112
800-462-5376

MISSOURI**ARONSON MOTORSPORTS**

CHILLICOTHE, MO 64601
660-646-4553
LS, EB, WH

GATEWAY CLASSIC MUSTANG

BOURBON, MO 65441
573-732-3541
LS, MO, IN

**PARTS MIDWEST INC –
LOWE STL**

ST. LOUIS, MO 63126
314-752-7477

NEVADA**SUMMIT RACING EQUIPMENT**

SPARKS, NV 89431
800-230-3030
LS, MO, WH

TURN 14 DISTRIBUTION

RENO, NV 89506
267-468-0350
WH

NEW JERSEY**JDM ENGINEERING INC**

FREEHOLD, NJ 07728
732-780-0770
LS, MO, EB, IN

JOE HECK RACING

OCEAN, NJ 7712
732-330-2329
LS, MO, WH

PAUL MACHENRY & COMPANY

MOORESTOWN, NJ 08057
800-969-3673
LS, MO, IN, WH

NEW YORK**NORTHCOAST PERFORMANCE**

ONTARIO, NY 14519
585-216-1210
LS, MO, WH

S-K SPEED RACING EQUIPMENT

LINDENHURST, NY 11757
631-957-9525
LS, MO, EB, WH

NORTH CAROLINA**DURHAM RACING ENGINES,
INC.**

THOMASVILLE, NC 27360
336-823-1866

G-FORCE TRANSMISSION

ASHBORO, NC 27205
336-625-3844

HARRIS MUSTANG SUPPLY

CHARLOTTE, NC 28269
704-598-1412

**ROUSH YATES PERFORMANCE
PARTS**

MOORESVILLE, NC 28117
704-662-6982
LS, MO, EB

RUDYS PERFORMANCE PARTS

BURLINGTON, NC 27215
919-383-9300

OHIO**JEGS HIGH PERFORMANCE**

COLUMBUS, OH 43211
614-294-5151
LS, MO, WH

JEGS HIGH PERFORMANCE

DELAWARE, OH 43015
800-345-4545
LS, MO, WH

**PAUL'S AUTOMOTIVE
ENGINEERING**

CINCINNATI, OH 45242
513-791-1087
LS, MO, EB, IN

SUMMIT RACING EQUIPMENT

TALLMADGE, OH 44278
800-230-3030
LS, MO, WH

OAKLAHOMA**CLASSIC RECREATIONS**

YUKON, OK 73099
405-577-6464
LS, EB, IN

OREGON**IVEY ENGINES**

PORTLAND, OR 97230
503-255-1123
EB

PENNSYLVANIA**AMERICANMUSCLE.COM**

MALVERN, PA 19355
1-866-727-1266
LS, MO, WH

AMERICAN TRUCKS

MALVERN, PA 19355
855-419-3557
LS, MO, WH

CJ PONY PARTS, INC.

HARRISBURG, PA 17112
800-888-6473
LS, MO, IN, WH

G-FORCE TRANSMISSION

CLEONA, PA 17042
717-202-8360

**KEYSTONE AUTOMOTIVE
OPERATIONS, INC.**

EXETER, PA 18643
570-655-4514

MCNEW'S AUTOMOTIVE

DILLSBURG, PA 17019
717-432-9503
LS, MO, EB, IN, WH

TURN 14 DISTRIBUTION

HATFIELD, PA 19440
267-468-0350
WH

TENNESSEE**RANDYS RING & PINION**

FRANKLIN, TN 37067
800-347-1188
LS, MO, IN, WH

TEXAS**LATEMODEL RESTORATION
SUPPLY INC.**

HEWITT, TX 76643
254-296-6500
LS, MO, WH

**SCOGGIN-DICKEY PARTS
CENTER**

LUBBOCK, TX 79424
800-456-0211
LS, MO, EB, WH

SUMMIT RACING EQUIPMENT

ARLINGTON, TX 76018
800-230-3030
LS, MO, WH

UTAH**FEC/NPW WAREHOUSE**

WEST VALLEY CITY, UT 84120
801-736-8000
WH

**FORD PERFORMANCE RACING
SCHOOL**

GRANTSVILLE, UT 84074
724-992-2460
LS

VERMONT**RPM RACING ENGINES**

GEORGIA, VT 05478
802-524-7406
LS, MO, EB, WH

VIRGINIA**BRYANT MOTORSPORTS**

SALEM, VA 24153
540-387-3854
LS, MO, EB, WH

WASHINGTON**ALDRIDGE MOTORSPORTS**

VANCOUVER, WA 98682
503-284-8484
LS, MO, EB, IN, WH

**FORD POWERTRAIN
APPLICATIONS**

PUYALLUP, WA 98371
253-848-9503
LS, MO, EB

NPW /WAREHOUSE WEST

RENTON, WA 98057
206-772-1910
WH

RANDY'S RING & PINION

EVERETT, WA 98204
800-347-1188
LS, MO, IN, WH

WISCONSIN**PARTS MIDWEST INC –
LOWE MLK**

WAUWATOSA, WI 53226
414-607-0200

PUERTO RICO**AUTO GRUPO FORD**

TOA BAJA, 949 PUERTO RICO
787-474-6565

FAJARDO FORD

ROAD #3 KM 41.8, FAJARDO,
00738-7005 PUERTO RICO
787-355-5555
LS, IN



DEALER LISTING (CONTINUED)

CANADA

WESTERN REGION

DENNY ANDREWS FORD SALES, INC.
EDMONTON, AB T5S 1A7
780-489-9999

PACIFIC REGION

BROWN BROS FORD SALES
VANCOUVER, BC V5X 2S6
604-324-7504
LS, IN, WH

WEST COAST FORD LINCOLN
MAPLE RIDGE, BC V2X 2P8
604-465-5481
LS, IN, WH

CENTRAL REGION

CAMPBELL FORD SALES, LTD.
OTTAWA, ON K1Z 0A3
613-725-3611
LS, MO, IN, WH

DIXIE FORD SALES
MISSISSAUGA, ON L4W 1E6
905-629-0003
LS, IN, WH

EASTGATE FORD
HAMILTON, ON L8H 5Y3
905-547-3211

KARBELT SPEED & CUSTOM
AJAX, ON L1S 4N8
905-619-6660
WH

LAMBTON FORD
SARNIA, ON N7T 3W1
519-464-4000

R.C.O. ENTERPRISES INC
AYLMER, ON N5H 2S1
800-297-0874
MO, WH

SMYL'S HIGHLAND FORD
SAULT STE MARIE, ON P6B 4Y5
705-759-5050

EASTERN REGION

FORMULE FORD INC
GRANBY, QC J2J 0M2
450-777-1777
LS, MO, IN, WH

SOUTH AFRICA

LAZ PERFORMANCE
CENTURION, 157
+27 12 649 4200

NEIL WOOLRIDGE MOTORS
PIETERMARITZBURG, 3201
27-72-778-3772

ARGENTINA

AUTOCARS/SPEEDSHOP DIRECT
LATIN AMERICA
SAN ISIDRO, 1642
805-466-4040
LS, MO, WH

AUSTRALIA

EAGLE AUTO SPARES
DANDENONG, VICT 3175
011 613 8710 3000
LS, MO, WH

TICKFORD
CAMPBELLFIELD, VICTORIA,
VICT 3061
+61 3 9300 7100

HERROD MOTORSPORT
THOMASTOWN MELBOURNE,
3074
+61 3 9464 5100
LS, EB, IN, WH

NEW ZEALAND

STA PARTS (SEGEDIN TRUCK & AUTO PARTS LTD)
AIRPORT OAKS, AUCK
011-649-256-1120
LS, MO, WH

CTB PERFORMANCE AND ACCESSOIRES
AUCKLAND, 2104
642783185
EB, IN, WH

EUROPEAN COUNTRIES

US-PARTS/FINN-AM OY
HELSINKI, SF00810, FINLAND 810
358-9-251-31999

REAL STEEL
COWLEY, MIDDLESEX UB8-2JP,
GREAT BRITAN
44-1895-440505
LS, MO, EB, WH

POWER TORQUE ENGINEERING LTD
BINLEY, COVENTRY CV3 2RQ,
UNITED KINGDOM
0046 02476 635757
LS, MO, WH

GRAND GARAGE PAUL WENGLER
ETTELBRUCK, LUXEMBOURG 9353
35281215735
LS, MO, IN, WH

HANSEN RACING AB
SPANGA, 163 54 SWEDEN
46 (0) 8 474 50 50

– OR –

See your local
Ford Dealer to
purchase Ford
Performance
Parts!

FORD PERFORMANCE CRATE ENGINE LIMITED WARRANTY

Rev. August 1, 2019

Ford Performance warrants for 24 months or 24,000 miles / 40,000 kilometres, whichever occurs first subsequent to the original retail purchase, that it will repair or replace, at its option, any Ford Performance engine part that, after inspection, is found to have failed due to a defect in factory supplied material or workmanship. Ford Performance may use new or remanufactured parts for replacement. This limited warranty is valid for the original retail purchaser and is transferable to subsequent owners.

Refer to the Ford Performance Crate Engine Warranty Reference Chart on the following page for specific coverage by Part Number.

Covered engine parts include the engine block and cylinder heads, all internally lubricated parts of the engine, including pistons, piston rings, piston pins, crankshaft and main bearings, connecting rods and rod bearings, camshaft and camshaft bearings, timing chain, timing chain gears, intake and exhaust valves, valve springs, oil pump, push rods, rocker arms, valve lash adjusters, hydraulic lifters and valve stem seals, to the extent that the original engine contains the referenced warranted part. Parts that require normal manufacturers recommended replacement intervals are not covered under this warranty.

In the Province of Quebec, none of the limitations and exclusions below will exclude or restrict the warranty provided for in Sections 37 and 38 of the Quebec Consumer Protection Act. This warranty does not preclude the operation of any other provincial statute, which in certain circumstances may not allow some of the limitations and exclusions described in this warranty.

To the extent allowed by law, loss of time, inconvenience, loss of the use of the vehicle, commercial loss and incidental and consequential damages are not covered. There is no other express or implied warranty on these Ford Performance engines including, but not limited to, any implied warranty of merchantability or fitness for a particular purpose.

This engine warranty does not cover:

- Sealed racing engines and other high-performance engines with mechanical lifter camshafts.
- Parts which are replaced as part of normal maintenance.
- Engine installation or removal costs.
- Damage due to improper engine installation, negligence, alteration or accident, including use related to competition racing or other on-track activities, marine or motorcycle applications or for other non-vehicle usage.
- Damage due to addition of power adders such as superchargers, turbochargers or nitrous oxide.
- Engines where the vehicle odometer has been disconnected or the mileage has been altered.
- Damage caused by lack of proper maintenance, failure to follow maintenance schedule intervals or failure to use or maintain proper type and levels of fluids, fuel, oil and lubricants, including accelerated wear from contaminated oil or fuel wash.
- Damage due to engine overheating or oil starvation.
- Damage resulting from improper engine tuning including, piston skirt scuffing, damage indicated by head gaskets exhibiting burned or crushed fire ring(s), or damage caused by improper combustion, detonation or pre-ignition, as indicated by melted, broken or eroded pistons.
- Damage resulting from improper transmission installation, including crankshaft thrust bearing damage on transmission side only.
- Damage caused by foreign objects dropped or drawn into cylinders or the crankcase.
- Towing, shipping, rental vehicles, loss of time, inconvenience, loss of use or other economic loss to the extent allowed by law, except in the Province of Quebec where reasonable costs of towing and shipping are covered.
- Ford Performance engines installed in vehicles registered and/or normally operated outside the United States or Canada.

Proof of proper maintenance is the owner's responsibility. Keep all maintenance receipts and be prepared to make them available.

To obtain warranty repair or replacement, please contact the Ford Performance Call Center at (800) 367-3788, International 01 (313) 621-0771, fwrnty@ford.com or PO Box 490, Dearborn, MI 48121.



FORD PERFORMANCE CRATE ENGINE LIMITED WARRANTY

Rev. August 1, 2019

PART NUMBER	DESCRIPTION	WARRANTY*
M-6006-M50C	2018-2019 MUSTANG 5.0L COYOTE LONG BLOCK	YES
M-6006-M50A1	5.0L COYOTE LONG BLOCK GEN 1	YES
M-6007-20T	2.0L 252HP ECOBOOST® ENGINE KIT	YES
M-6007-23TA	2.3L 310HP MUSTANG ECOBOOST® ENGINE KIT	YES
M-6007-A50NAB	5.0L GEN 3 ALUMINATOR N/A 12.0:1	YES
M-6007-A50SCB	5.0L GEN 3 ALUMINATOR S/C 9.5:1	YES
M-6007-A50NAA	5.0L GEN 2 ALUMINATOR N/A 11.0:1	YES
M-6007-A50SCA	5.0L GEN 2 ALUMINATOR S/C 9.5:1	YES
M-6007-A52XS	5.2L 580HP COYOTE ALUMINATOR XS	YES
M-6007-M50A	5.0L 435HP MUSTANG GEN 2 ENGINE-MANUAL	YES
M-6007-M50AAUTO	5.0L 435HP MUSTANG GEN 2 ENGINE-AUTOMATIC	YES
M-6007-M50SA	5.0L 435HP MUSTANG GEN 2 CRATE ENGINE-SEALED RACING	--
M-6007-M50C	5.0L 460HP MUSTANG GEN 3 CRATE ENGINE-MANUAL	YES
M-6007-M50CAUTO	5.0L 460HP MUSTANG GEN 3 ENGINE-AUTO	YES
M-6009-A50NAB	5.0L GEN 3 COYOTE ALUMINATOR NA SHORT BLOCK	--
M-6009-A50SCB	5.0L GEN 3 COYOTE ALUMINATOR SC SHORT BLOCK	--
M-6009-A50NAA	5.0L GEN 2 COYOTE ALUMINATOR NA SHORT BLOCK	--
M-6009-A50SCA	5.0L GEN 2 COYOTE ALUMINATOR SC SHORT BLOCK	--
M-6009-B53	5.3L MODULAR BOSS STROKER SHORT BLOCK	--
M-9000-PMCA3	5.0L 460HP COYOTE POWER MODULE 10 SPEED AUTOMATIC	YES
M-9000-PMCM3	5.0L 460HP COYOTE POWER MODULE WITH 6 SPEED MANUAL	YES
M-9000-PMCA	5.0L 435HP COYOTE POWER MODULE 6 SPEED AUTOMATIC	YES
M-9000-PMCAA	5.0L 435HP COYOTE POWER MODULE WITH 6 SPEED REMAN TRANSMISSION	YES
M-9000-PMCM	5.0L COYOTE POWER MODULE 6 SPEED MANUAL	YES
M-9000-PMCA	5.0L COYOTE POWER MODULE 6 SPEED AUTOMATIC	YES
M-9000-PMCM	5.0L COYOTE POWER MODULE 6 SPEED MANUAL	YES

*Limited Engine Warranty of 2 yr. or 24,000 mi. or 40,000 km.

FORD PERFORMANCE CRATE ENGINE LIMITED WARRANTY

Late Model Engine Reference Chart Rev. August 1, 2019

PART NUMBER	DESCRIPTION	WARRANTY*
M-6007-D347SR	347CI 415HP ENGINE-SEALED RACING	--
M-6007-D347SR7	347CI 415HP ENGINE-SEALED RACING-7MM	--
M-6007-S347JR2	347CI 350HP CRATE ENGINE-SEALED RACING	--
M-6007-X2302E	302CI 340HP BOSS CRATE ENGINE WITH "E" CAMSHAFT	YES
M-6007-X2347DF	347CI 360HP DRESSED CRATE ENGINE-FRONT SUMP	YES
M-6007-X2347DR	347CI 360HP DRESSED CRATE ENGINE-REAR SUMP	YES
M-6007-Z2363FT	363CI 500HP CRATE ENGINE-FRONT SUMP	YES
M-6007-Z2363RT	363CI 500HP CRATE ENGINE-REAR SUMP	YES
M-6007-Z2427FFT	427CI 535HP CRATE ENGINE-FRONT SUMP	YES
M-6007-Z2427FRT	427CI 535HP CRATE ENGINE-REAR SUMP	YES
M-6007-Z460FFT	460CI 575HP CRATE ENGINE-FRONT SUMP	YES
M-6007-Z460FRT	460CI 575HP CRATE ENGINE-REAR SUMP	YES
M-6007-572DF	572 655HP STREET CRATE ENGINE-FRONT SUMP	YES
M-6007-572DR	572 655HP STREET CRATE ENGINE-REAR SUMP	YES
M-6009-347	347 CUBIC INCH BOSS SHORT BLOCK	--
M-6009-363	363 CUBIC INCH BOSS SHORT BLOCK	--
M-6009-427A	427 CUBIC INCH ALUMINUM SHORT BLOCK	--
M-6009-427F	427 CUBIC INCH BOSS SHORT BLOCK	--
M-6009-460	460 CUBIC INCH BOSS SHORT BLOCK	--
M-6009-427A	427 CUBIC INCH ALUMINUM SHORT BLOCK	—
M-6009-427F	427 CUBIC INCH BOSS SHORT BLOCK	—
M-6009-460	460 CUBIC INCH BOSS SHORT BLOCK	—

*Limited Engine Warranty of 2 yr. or 24,000 mi. or 40,000 km.



SELECT FORD PERFORMANCE PARTS LIMITED WARRANTY

Rev. August 1, 2019

Ford Motor Company, The American Road, Dearborn, MI 48025, provides a Limited Warranty on select Ford Performance Parts and as described herein when installed on late model Ford vehicles. This warranty works in conjunction with -- and does not void -- the Manufacturer's New Vehicle Limited Warranty. It is valid for the original retail purchaser of the vehicle and is transferable to subsequent vehicle owners.

Performance Packs and Component Parts

Performance Packs and Components are warranted for factory-supplied material or workmanship when correctly and completely installed on a late model Ford vehicle by an authorized Ford or Lincoln Dealer, Shelby American, Inc., or an automotive service technician certified by the Institute for Automotive Service Excellence (ASE) or endorsed by the Red Seal Program (RSE). This Performance Packs and Components Limited Warranty begins upon installation and registration of the part(s) with Ford Performance and remains in effect for the balance of 36 months or 36,000 miles / 60,000 kilometres, whichever occurs first, *calculated from the start date of the manufacturer's New Vehicle Limited Warranty.*

Installation of these select Ford Performance warranted performance packs and components by an authorized installer will NOT void your New Vehicle Limited Warranty. Engine, driveline and suspension concerns not caused by the use of Ford Performance parts remain eligible for warranty coverage according to the terms of the New Vehicle Limited Warranty.

Ford Performance parts are aftermarket parts. The use of Ford Performance parts may impact the performance characteristics of other systems of the vehicle. Even when operating properly, Ford Performance parts, such as these, have the potential to adversely impact other systems of the vehicle. If an adverse impact is caused by a warranted Ford Performance pack or component, the period and coverage of this Ford Performance Limited Warranty applies to the repairs.

Premium Fuel Requirement: Customers who purchase power upgrade packs, cold air kits with calibration, engine calibrations, or superchargers are required to use 91-octane or higher ("premium") fuels at all times. Any failures associated with the non-use of premium fuel will be ineligible for warranty repair.

Performance Handling Pack FR3/FR3A Note: Performance handling packs are designed for "Track Day" ride and handling. Such performance standards suggest the vehicle ride will be more indicative of race performance vehicles. Certain vehicle conditions including, but not limited to, squeaks, rattles and harsh ride related to use of a Performance Handling Pack or components will not be covered under this Limited Warranty. The performance handling pack requires the use of original equipment size wheels only. It is strongly recommended after installation that the alignment be checked to ensure measurements are within factory specifications. Premature tire degradation will not be covered under this Limited Warranty. Contact the **Ford Performance Call Center at (800) 367-3788 or fwrnty@ford.com** for front end alignment information.

Warranty Registration: This Limited Warranty requires that parts must be purchased from an authorized Ford Performance Distributor and installed by an authorized Ford or Lincoln Dealer, Shelby American, Inc., or an automotive service technician certified by the Institute for Automotive Service Excellence (ASE) or endorsed by the Red Seal Program (RSE). Proof of purchase is required for submission of warranty claims. Registration for this warranty must be submitted through the **Ford Performance Call Center at (800) 367-3788 or fwrnty@ford.com** with the vehicle identification number (VIN), part installation repair order and date, Ford Performance part number, and owner contact information.

WARRANTED PERFORMANCE PACKS AND COMPONENT PARTS

The Ford Performance Parts Limited Warranty covers the following select Mustang, Focus, F-150 and Taurus performance pack and component part numbers:

Mustang GT

Power Upgrade Packs: M-9452-M8 (2015-17)

Cold Air Kits/High-Flow Filters w/ Calibration: M-9603-M8 (2015-17); M-9603-M8A (2015-17)

Shifters: M-7210-MA (2015-19)

Handling Packs/Suspension: M-9602-M (2018); M-FR3A-M8A (2015-19); M-FR3A-MA (2015-19)

Exhaust/X-Pipe: M-5230-M8 (2015-17); M-5200-M8*** (2015-17); M-5220-M8*** (2016-17); M-5200-M8*** (2018-19); M-5220-M8 (2015-19); M-5230-M8*** (2015-17); M-5230-M**** (2018-19); M-5231-M8 (2015-19); M-5251-M8 (2015-18)

Power Modules: M-9000PMC***

Mustang EcoBoost®

Cold Air Kits/High-Flow Filters w/ Calibration: M-9603-M4 (2015-17); M-9603-M4C (2018-19)

Shifters: M-7210-MA (2015-19)

Handling Packs: M-FR3A-MA (2015-19); M-FR3A-MAA (2015-19)

Exhaust: M-5230-M4*** (2015-17); M-5200-M4*** (2015-19); M-5200-M4*** (2016-17),

Mustang GT350

Shifters: M-7210-M8* (2015-19)

Handling Pack: M-FR3-M8SBY (2015)

Exhaust: M-5200-MSS (2015-17)

Focus/Focus ST/Focus RS

Power Upgrade Packs: M-FR1-FSTA (2013-18)

Calibration/Cold Air Kits w/ Calibration: M-14204-FSTA (2013-18); M-9603A-FSTA (2013-18)

Shifters: M-7210-FST (2013-18); M-7210-FRS (2016-18)

Exhaust Focus: M-5230-FSH (2012-18)

Exhaust Focus ST: M-5200-FST (2013-18)

Exhaust Focus RS: M-5200-FRS (2016-18)

F-150/F-150 Raptor

Exhaust F-150 2.7L: M-5200-F1527**** (2015-19); M-5248-F15157 (2015-17); M-5248-F151*** (2018)

Exhaust F-150 3.5L: M-5200-F1535145L (2011-14); M-5200-F1535126L (2014); M-5200-F1535**** (2015-19); M-5248-F151*** (2011-14); M-5248-F15157 (2015-17); M-5248-F151*** (2018)

Exhaust F-150 5.0L: M-5200-F1550**** (2015-19); M-5248-F151*** (2011-14); M-5248-F15157 (2015-17); M-5248-F151*** (2018)

Exhaust Raptor 6.2L: M-5248-F15R133* (2011-14)

Exhaust Raptor 3.5L: M-5248-F15R*** (2017-19); M-5248-F15R133 (2017-18)

Exhaust Ranger 2.3L: M-5200-RA23S* (2019)

TAURUS SHO

Exhaust: M-5200-SHOTC (2010-17)

Note: Asterisks () above indicate additional digits at the end of the part number based on vehicle specification.



SELECT FORD PERFORMANCE PARTS LIMITED WARRANTY

Rev. August 1, 2019

Fox Suspension Leveling Kits Tuned by Ford Performance F-150 MY 2015-2019 and Ranger MY 2019

Ford Motor Company, The American Road, Dearborn, MI 48025, provides a Limited Warranty on select Ford Performance off-road suspension damper kits and as described herein when installed on select late model Ford vehicles. This warranty works in conjunction with -- and does not void -- the Manufacturer's New Vehicle Limited Warranty. It is valid for the original retail purchaser of the vehicle and is transferable to subsequent vehicle owners.

The Fox Suspension Leveling Kits **M-18000-F15A** and **M-18000-R** are warranted for factory-supplied material or workmanship when correctly and completely installed by an authorized Ford or Lincoln Dealer, Shelby American, Inc., or an automotive service technician certified by the Institute for Automotive Service Excellence (ASE) or endorsed by the Red Seal Program (RSE). This Limited Warranty begins upon installation and registration of the part(s) with Ford Performance and remains in effect for the balance of 12 months or 12,000 miles / 20,000 kilometres, whichever occurs first, calculated from the date of installation.

Installation of these select Ford Performance warranted suspension leveling kits by an authorized installer will NOT void your New Vehicle Limited Warranty. Engine, driveline and suspension concerns not caused by the use of Ford Performance parts remain eligible for warranty coverage according to the terms of the New Vehicle Limited Warranty.

Ford Performance parts are aftermarket parts. The use of Ford Performance parts may impact the performance characteristics of other systems of the vehicle. Even when operating properly, Ford Performance parts, such as these, have the potential to adversely impact other systems of the vehicle. If an adverse impact is caused by a warranted Ford Performance suspension leveling kit, the period and coverage of this Ford Performance Limited Warranty applies to the repairs.

It is strongly recommended after installation that the wheel alignment be checked to ensure measurements are within factory specifications. Premature tire degradation will not be covered under this Limited Warranty. Contact the **Ford Performance Call Center at (800) 367-3788 or fwrnty@ford.com** for front end alignment information.

Warranty Registration: This Limited Warranty requires that parts must be purchased from an authorized Ford Performance Distributor and installed by an authorized Ford or Lincoln Dealer, Shelby American, Inc., or an automotive service technician certified by the Institute for Automotive Service Excellence (ASE) or endorsed by the Red Seal Program (RSE). Proof of purchase is required for submission of warranty claims. Registration for this warranty must be submitted through the **Ford Performance Call Center at (800) 367-3788 or fwrnty@ford.com** with the vehicle identification number (VIN), part installation repair order and date, Ford Performance part number, and owner contact information.

SELECT FORD PERFORMANCE PARTS LIMITED WARRANTY

Rev. August 1, 2019

Mustang Superchargers MY 2015-2017

Select superchargers are warranted for factory-supplied material or workmanship when correctly and completely installed by an authorized Ford or Lincoln Dealer, Shelby American, Inc. or an automotive service technician certified by the Institute for Automotive Service Excellence (ASE) or endorsed by the Red Seal Program (RSE).

Installation of these select Ford Performance warranted superchargers by an authorized installer will NOT void your New Vehicle Limited Warranty. Engine, driveline and suspension concerns not caused by an installed Ford Performance supercharger remain eligible for warranty coverage according to the terms of the New Vehicle Limited Warranty.

Ford Performance superchargers are aftermarket parts. The use of Ford Performance superchargers may impact the performance characteristics of other systems of the vehicle. Even when operating properly, Ford Performance superchargers, such as these, have the potential to adversely impact other systems of the vehicle. Engine, driveline and suspension concerns caused by an installed Ford Performance supercharger are not eligible for warranty coverage according to the terms of the New Vehicle Limited Warranty or this Ford Performance Supercharger Limited Warranty.

Supercharger Application: Superchargers are covered by this Limited Warranty only when installed by an authorized installer on a 5.0L engine in the vehicle for which they were designed, i.e. the Mustang GT MY 2015-2017 and the Shelby GT MY 2015-2017.

Ford Performance Parts Limited Warranty supercharger coverage: Part Number **M-6066-M8627** is warranted for factory-supplied material or workmanship for 36 months or 36,000 miles / 60,000 kilometres from the vehicle's original in-service date as determined by Ford OASIS (On-Line Service Information System). Contact **(800) 367-3788** for warranty concerns or warranty claim prior approval.

Premium Fuel Requirement: Customers who purchase superchargers are required to use 91-octane or higher ("premium") fuels at all times. Any failures associated with the non-use of premium fuel will be ineligible for warranty repair.

Warranty Registration: This limited warranty requires that parts must be purchased from an authorized Ford Performance Parts Distributor Dealer and installed by an authorized Ford or Lincoln Dealer, Shelby American, Inc. or an automotive service technician certified by the Institute for Automotive Service Excellence (ASE) or endorsed by the Red Seal Program (RSE). Proof of purchase is required for submission of warranty claims. Registration for this warranty must be submitted through the **Ford Performance Call Center at (800) 367-3788 or fwrnty@ford.com** with the vehicle identification number (VIN), part installation repair order and date, Ford Performance Parts part number, and owner contact information.



SELECT FORD PERFORMANCE PARTS WARRANTY LIMITATIONS

Rev. August 1, 2019

The following limitations apply to the products covered by the Ford Performance Parts Limited Warranty:

- The purchase invoice(s) is required for submission of warranty claims.
- Where a warranted Ford Performance part is replaced under this Limited Warranty, the replacement Ford Performance part is warranted only for the time remaining in the original Limited Warranty.
- This warranty does not cover parts with:
 - Damage as a result of misuse of a vehicle, such as competitive racing, overloading, driving over curbs or using the vehicle as a stationary power source.
 - Damage or corrosion due to accidents, misuse, negligence, lack of proper maintenance or failure to follow maintenance schedule intervals. Proof of proper maintenance is the owner's responsibility. Keep all receipts and be prepared to make them available.
 - Damage or surface corrosion from the environment such as acid rain, airborne fallout (chemicals, tree sap), stones, salt road hazards, wind storm, lightning, floods and other natural disasters.
 - Normal wear, tear or deterioration such as discoloration, fading, or blurring.
 - Damage due to improper installation, alteration, including calibration, use related to racing or competition, marine or motorcycle applications, or other non-vehicle usage.
- This warranty does not cover:
 - Non-Ford Performance parts or Genuine Ford replacement parts or accessories which Ford Dealers may sell or install on your Ford vehicle.
 - Parts replaced or labor charges incurred as part of normal vehicle maintenance.
 - Engine damage associated with use of fuels less than 91-octane.
 - Replacement parts or accessories installed on a Ford vehicle in which the odometer has been altered, or on which the actual mileage cannot be readily determined.
 - Replacement parts or accessories used in applications for which they are not designed.
 - Towing, shipping, rental vehicles, loss of time, inconvenience, loss of use or other economic loss to the extent allowed by law, except in the Province of Quebec where reasonable costs of towing and shipping are covered.
 - Parts installed in vehicles registered and/or operated outside the United States or Canada.

- Should Ford Performance modify any currently released parts which apply to this warranty program, Ford Performance is not obligated to update any previously manufactured parts.
- In the Province of Quebec, none of the limitations and exclusions above exclude or restrict the warranty provided for in sections 37 and 38 of the Quebec Consumer Protection Act.

NOTE: Federal and many state and provincial laws prohibit the removal, modification or rendering inoperative of any part that effects emissions or safety on motor vehicles used on public streets or highways. Ford Performance customers are responsible for complying with applicable federal, state, provincial and local environmental laws, including but not limited to, with respect to vehicle emissions. It is the responsibility of the customer to determine if their modified vehicle complies with applicable laws.

THIS LIMITED WARRANTY GIVES YOU SPECIFIC LEGAL RIGHTS. YOU MAY HAVE OTHER RIGHTS THAT VARY FROM STATE TO STATE AND PROVINCE TO PROVINCE. THIS LIMITED WARRANTY IS THE ONLY EXPRESS WARRANTY APPLICABLE TO THESE PARTS. FORD PERFORMANCE AND FORD MOTOR COMPANY ARE NOT RESPONSIBLE FOR ANY TIME FOR WHICH YOU MAY LOSE THE USE OF YOUR VEHICLE, ANY INCONVENIENCE YOU MIGHT BE CAUSED, THE LOSS OF YOUR TRANSPORTION OR ANY PART THEREOF, OR ANY OTHER INCIDENTAL OR CONSEQUENTIAL DAMAGES YOU MAY HAVE. YOU MAY HAVE SOME IMPLIED WARRANTIES UNDER STATE OR PROVINCIAL LAW, FOR EXAMPLE, THE IMPLIED WARRANTY OF MERCHANTABILITY OR THE IMPLIED WARRANTY OF FITNESS FOR A PARTICULAR PURPOSE.

Questions or concerns relating to this warranty policy may be answered by contacting the **Ford Performance Call Center at (800) 367-3788, International 01 (313) 621-0771, or fwrnty@ford.com.**

CONSUMER DISCLAIMER NOTICE

Rev. August 1, 2019

All Ford Performance Parts are aftermarket parts. Ford Performance parts are not Genuine Ford Parts. Therefore, they may not be used in any application that requires the use of Genuine Ford Parts. The use of Ford Performance parts and components may impact the performance characteristics of other systems of the vehicle. When operating properly, Ford Performance crate engines, performance parts and components have the potential to adversely impact other systems of the vehicle. Except as set forth herein, such damage is the sole responsibility of the consumer and is not covered by this Limited Warranty.

Consumers are solely and completely responsible for evaluating their vehicle to ensure that the vehicle, and each part of that vehicle, is appropriate for this Ford Performance engine, part or component. It is the consumer's sole responsibility to have the performance enhancement parts properly installed on their vehicle along with any modifications necessary for the proper performance of the vehicle. Vehicle damage caused by a consumer's failure to modify the vehicle properly for use of one or more Ford Performance parts and components is not covered by this Limited Warranty and is the sole responsibility of the consumer. This Limited Warranty and/or the New Vehicle Limited Warranty on your vehicle may be voided, either in whole or in part, where the vehicle has been damaged due to a consumer's failure to modify the vehicle properly as necessary for use of Ford Performance parts and components.

Most Ford Performance parts are not sold with a warranty. Ford Performance parts are sold "as is", "with all faults", "as they stand" and without any express warranty whatsoever, unless otherwise expressly designated herein. To the fullest extent allowed by the state and federal law, Ford Motor Company expressly disclaims the implied warranties of merchantability and of fitness for a particular purpose, even if a particular purpose is mentioned herein. Ford also expressly disclaims all liability for direct, indirect, special, incidental or consequential damages, including but not limited to, damage or loss of property or equipment, loss of profits or revenue, cost of purchase or replacement of goods, or claims of customers of the purchaser that result from the use of any and all parts or vehicles contained in this catalog. In no event shall the liability of Ford Motor Company, whether in tort, contract or otherwise, exceed the cost of the part or vehicle. However, you may have legal rights which vary from state to state.

Should any parts contained within this catalog prove defective following their purchase, the buyer and not the manufacturer, distributor or retailer, shall assume the entire cost of all necessary servicing and/or repair. The entire risk as to the performance of such parts or vehicles is with the buyer.

No vehicle in this catalog or offering is street legal or certified under federal motor vehicle safety standards and regulations. Vehicles that are not street legal or certified under federal motor vehicle safety standards and regulations are neither intended nor certified for use on public roads. Many of the parts in this catalog are not designed or tested for crashworthiness or to meet the safety needs of the motoring public. Instead, these parts are designed and intended for race vehicles on race tracks with engineers supervising the installation and use of the race parts to ensure that the safety needs of the race driver are met. The racing parts could conceivably be combined in an infinite combination, and the use of some parts on some vehicles could adversely affect the performance of the vehicle or other race parts.

To the extent that a part contained within this catalog comes with a warranty from the original manufacturer, not Ford Performance or Ford Motor Company, the buyer should contact the original manufacturer for any and all warranty repair or replacement. To determine which parts come with a warranty from the original manufacturer, not Ford Performance, please contact the **Ford Performance Call Center at (800) 367-3788, fwrnty@ford.com** or:

**FORD PERFORMANCE PARTS
P.O. BOX 490
DEARBORN, MI 48121**

PARTS INDEX

PART DESCRIPTION	PART NUMBER	PAGE
2.3L ECOBOOST 70MM BILLET THROTTLE BODY	M-9926-M2370	163
2.3L ECOBOOST BALANCE SHAFT BLOCK-OFF PLUG	M-6026-23BSBP	114
2.3L ECOBOOST ENGINE CONTROL PACK	M-6017-23T	161
2.3L ECOBOOST MUSTANG ENGINE BLOCK	M-6010-23T	114
2.3L ECOBOOST PERFORMANCE CALIBRATION KIT, 2015-2017 MUSTANG	M-9603-M4	9
2.3L ECOBOOST SPORT MUFFLER KIT WITH GT350 EXHAUST TIPS & LOWER VALANCE, 2015-2017 MUSTANG	M-5230-M4SBV	15
2.3L ECOBOOST TOURING MUFFLER KIT - CHROME TIPS, 2015-2017 MUSTANG	M-5230-M4TC	15
2.3L MUSTANG ECOBOOST ENGINE KIT, 310HP	M-6007-23TA	113
2.3L MUSTANG ECOBOOST OIL-AIR SEPARATOR LH	M-6766-A23	10
2.3L MUSTANG ECOBOOST OIL-AIR SEPARATOR RH	M-6766-A23S	10
302 CI 340 HP BOSS CRATE ENGINE WITH "E" CAM	M-6007-X2302E	117
302 DEEP REAR SUMP OIL PAN	M-6675-DRS302	132
302 DEEP REAR SUMP OIL PICKUP TUBE	M-6622-DRS302	132
302 ENGINE-UNIVERSAL OIL DIPSTICK/TUBE	M-6622-302	95
302 FRONT SUMP OIL PAN PICKUP TUBE	M-6622-FT302	132
302 FRONT T-SUMP RACING OIL PAN	M-6675-FT302	132
302 HEAD GASKET AND BOLT KIT	M-6051-D50	140
302 ONE PIECE REAR MAIN OIL SEAL	M-6701-B302	139
302/351 BELLHOUSING FOR TREMEC® 5-SPEED	M-6392-R58	173
302/351 HEAD GASKET SET	M-6051-C51	140
302/351 HEAD GASKET SET	M-6051-CP331	140
302/351 HEADGASKET SET	M-6051-S331	140
302/351 T-5 BELLHOUSING	M-6392-E	172
302/351W "X2" STREET CRUISER ASSEMBLED ALUMINUM CYLINDER HEAD 64CC	M-6049-X2	134
302/351W "Z" ALUMINUM CNC PORTED, ASSEMBLED CYLINDER HEAD	M-6049-Z304PA	133
302/351W "Z-HEAD" ALUMINUM - ASSEMBLED 63CC	M-6049-Z304DA	135
302/351W "Z-HEAD" ALUMINUM - ASSEMBLED 63CC WITH 7MM VALVE	M-6049-Z304DA7	135
302/351W "Z-HEAD" ALUMINUM 63CC W/7MM VALVES	M-6049-Z304D7	135
302/351W "Z-HEAD" ALUMINUM CNC PORTED - BARE 59CC	M-6049-Z304P	135
302/351W "Z-HEAD" ALUMINUM HEAD - BARE 63CC	M-6049-Z304D	135
302/351W CAMSHAFT THRUST PLATE	M-6269-A302	130
302/351W CRANKSHAFT PULLEY SPACER - 0.350"	M-8510-A351	131
302/351W CRANKSHAFT PULLEY SPACER - 0.875"	M-8510-C351	131
302/351W CRANKSHAFT PULLEY SPACER - 0.909"	M-8510-D351	131
302/351W CRANKSHAFT PULLEY SPACER - 0.950"	M-8510-B351	131
302/351W DOUBLE ROLLER TIMING CHAIN SET - CAST IRON GEAR	M-6268-A302	138
302/351W DOUBLE ROLLER TIMING CHAIN SET-STEEL GEAR	M-6268-B302	138
302/351W INTAKE MANIFOLD GASKET	M-9439-A50	141
302/351W MAXIMUM FLOW ALUMINUM WATER PUMP	M-8501-F351	143
302/351W PERFORMANCE CRANKSHAFT DAMPER	M-6316-D302	130
302/351W STREET ROD SHORT V-BELT WATER PUMP	M-8501-E351S	142
302/5.0L ENGINE SWAP OIL PAN KIT	M-6675-A50	131
347CI 350HP CRATE ENGINE-SEALED RACING X2 CYLINDER HEAD	M-6007-S347JR2	118
347CI 415 HP SEALED RACING ENGINE	M-6007-D347SR	119
347CI 415 HP SEALED RACING ENGINE 7MM VALVES	M-6007-D347SR7	119
347CI BOSS SHORT BLOCK	M-6009-347	123
351 ALUMINUM BLOCK 9.2-INCH DECK	M-6010-Z35192	126
351 ALUMINUM BLOCK 9.5-INCH DECK	M-6010-Z351	125
351 DEEP REAR SUMP OIL PAN	M-6675-DRS351	132
351 DEEP REAR SUMP OIL PICKUP TUBE	M-6622-DRS351	132
351 DEEP REAR SUMP OIL PICKUP TUBE FOR Z351 ALUMINUM BLOCK	M-6622-DRS351A	131
351 FRONT SUMP OIL PAN PICKUP TUBE	M-6622-FT351	132
351 FRONT T-SUMP RACING OIL PAN	M-6675-FT351	132
351C DOUBLE ROLLER TIMING CHAIN SET	M-6268-A351	138
351W HIGH VOLUME OIL PUMP	M-6600-B3	131
351W OIL PAN REINFORCEMENT RAILS	M-6674-351	133
351W OIL PUMP DRIVE SHAFT	M-6605-A341	131
351W ONE PIECE REAR MAIN OIL SEAL	M-6701-B351	139
351W/5.8L ENGINE SWAP OIL PAN KIT	M-6675-A58	131
351W/5.8L ONE-PIECE RUBBER OIL PAN GASKET	M-6710-A351	141
363CI 507 HP BOSS CRATE ENGINE-Z2 HEADS-FRONT SUMP PAN	M-6007-Z2363FT	120
363CI 507 HP BOSS CRATE ENGINE-Z2 HEADS-REAR SUMP PAN	M-6007-Z2363RT	120
363CI BOSS SHORT BLOCK	M-6009-363	123
390/427/428 DOUBLE ROLLER TIMING CHAIN SET	M-6268-A390	148
4.6 LITER ALUMINUM BLOCK PLUG AND DOWEL KIT	M-6026-A46	106

PART DESCRIPTION	PART NUMBER	PAGE
4.6L 2V 6 BOLT NODULAR IRON MUSTANG FLYWHEEL	M-6375-D46	175
4.6L 2V CAMSHAFT DRIVE KIT	M-6004-462V	106
4.6L 2V SOHC HEAD CHANGING KIT	M-6067-D46	108
4.6L 3V ALUMINUM BLOCK MAIN CAP BOLT KIT	M-6345-A46	106
4.6L 3V CAMSHAFT BOLT	M-6279-463V	109
4.6L 3V CAMSHAFT DRIVE KIT	M-6004-463V	107
4.6L 3V HEAD CHANGING KIT	M-6067-3V46	108
4.6L 3V PERFORMANCE INTAKE MANIFOLD	M-9424-463V	110
4.6L 4V CAMSHAFT DRIVE KIT	M-6004-A464	107
4.6L 4V HEAD CHANGING KIT	M-6067-T46	109
4.6L 6 BOLT BILLET STEEL MUSTANG FLYWHEEL	M-6375-F46A	175
4.6L 8 BOLT ALUMINUM MUSTANG FLYWHEEL	M-6375-R00A	175
4.6L 8 BOLT BILLET STEEL MUSTANG FLYWHEEL	M-6375-G46A	175
4.6L HIGH VOLUME OIL PUMP AND PICKUP TUBE	M-6600-D46	106
4.6L MANUAL FLYWHEEL BOLTS	M-6379-B	173
4.6L PERFORMANCE IMPROVEMENT (PI) INTAKE MANIFOLD	M-9424-P46	110
4.6L/5.0L/5.4L MODULAR BELLHOUSING	M-6392-M46	173
4.6L/5.4L 3V IGNITION COIL SET	M-12029-3V	111
4.6L/5.4L 4V "FORD RACING" CAST COIL COVERS	M-6067-D	112
427 ALUMINUM SHORT BLOCK	M-6009-427A	124
427 CUBIC INCH 535 HP BOSS CRATE ENGINE-Z2 HEADS-FRONT SUMP PAN	M-6007-Z2427FFT	121
427 CUBIC INCH 535 HP BOSS CRATE ENGINE-Z2 HEADS-REAR SUMP PAN	M-6007-Z2427FRT	121
427 CUBIC INCH BOSS SHORT BLOCK	M-6009-427F	124
429/460 CRANKSHAFT REAR MAIN OIL SEAL	M-6701-A460	150
429/460 HIGH VOLUME OIL PUMP	M-6600-A460	149
429/460 OIL PUMP DRIVESHAFT	M-6605-A429	149
429/460 ONE-PIECE RUBBER OIL PAN GASKET	M-6710-A460	150
429/460 DOUBLE ROLLER TIMING CHAIN SET	M-6268-A460	148
429/460 DOUBLE ROLLER TIMING CHAIN SET	M-6268-B429	148
460 "SPORTSMAN" WEDGE-STYLE CYLINDER HEADS, FORD PERFORMANCE	M-6049-C460	146
460 ALUMINUM VALVE COVER SATIN BLACK	M-6582-B460	190
460 BIG BLOCK TIMING COVER	M-6059-460	150
460 BIG BLOCK WATER PUMP BACKING PLATE	M-8501-460BP	150
460 CUBIC INCH 575 HP BOSS CRATE ENGINE-FRONT SUMP PAN	M-6007-Z460FFT	122
460 CUBIC INCH 575 HP BOSS CRATE ENGINE-REAR SUMP PAN	M-6007-Z460FRT	122
460 CUBIC INCH BOSS SHORT BLOCK - WINDSOR SB BASED	M-6009-460	125
460 DEEP REAR SUMP OIL PAN	M-6675-DRS460	149
460 DEEP REAR SUMP OIL PICKUP TUBE	M-6622-DRS460	149
460 ENGINE SWAP OIL PAN KIT	M-6675-A460	150
460 FRONT SUMP OIL PAN	M-6675-FT460	149
460 FRONT SUMP OIL PAN PICKUP TUBE	M-6622-FT460	149
460 SIAMESE BIG BORE CYLINDER BLOCK	M-6010-A460XBB	145
460 SIAMESE BIG BORE CYLINDER BLOCK	M-6010-A460X	145
460/460 FORD PERFORMANCE SINGLE PLANE INTAKE MANIFOLD	M-9424-C460	148
460/514 CRANKSHAFT DAMPER SPACER	M-6359-D460	149
5.0L 3V HEAD CHANGING KIT	M-6067-3V50	108
5.0L 4V COYOTE 90MM THROTTLE BODY INTAKE SPACER	M-9474-M50	165
5.0L CAST IRON MODULAR BOSS ENGINE BLOCK	M-6010-BOSS50	105
5.0L COBRA JET COLD AIR KIT	M-9603-M50CJ	36
5.0L COYOTE "POWERED BY FORD" BLACK COIL COVERS	M-6P067-M50BL	102
5.0L COYOTE "POWERED BY FORD" BLUE COIL COVERS	M-6P067-M50B	102
5.0L COYOTE AIR CONDITIONING KIT	M-8600-M50AC	104
5.0L COYOTE ALUMINATOR NA SHORT BLOCK 11.0:1	M-6009-A50NAA	89
5.0L COYOTE ALUMINATOR NA SHORT BLOCK 12.0:1	M-6009-A50NAB	88
5.0L COYOTE ALUMINATOR SC SHORT BLOCK 9.5:1	M-6009-A50SCA	89
5.0L COYOTE ALUMINATOR SC SHORT BLOCK 9.5:1	M-6009-A50SCB	88
5.0L COYOTE ALUMINUM PERFORMANCE BLOCK	M-6010-M50R	91
5.0L COYOTE AUTO TRANS ENGINE HARNESS	M-12508-M50A	162
5.0L COYOTE AUTOMATIC TRANSMISSION FLEXPLATE AND BOLTS	M-6375-A50C	103
5.0L COYOTE AUTOMATIC TRANSMISSION FLEXPLATE BOLTS	M-6379-M50A	103
5.0L COYOTE BLACK COIL COVER - FORD PERFORMANCE LOGO	M-6067-50FPB	101
5.0L COYOTE BLACK COIL COVER - FORD RACING LOGO	M-6067-50BK	101
5.0L COYOTE BLOCK HARDWARE KIT 2011-19	M-6026-A50A	92
5.0L COYOTE BLUE COIL COVER - FORD PERFORMANCE LOGO	M-6067-50FP	101
5.0L COYOTE BOSS 302 TIMING CHAIN TENSIONERS	M-6266-M50B	100
5.0L COYOTE CAM COVER BALL STUD KIT	M-6067B-F150	102
5.0L COYOTE CHROME COIL COVER - FORD RACING LOGO	M-6067-50C	101
5.0L COYOTE COIL COVER BOSS 302	M-6067-50B302	101
5.0L COYOTE ENGINE HARNESS	M-12508-M50	162

PART DESCRIPTION	PART NUMBER	PAGE
5.0L COYOTE FLYWHEEL BOLT KIT	M-6379-C	173
5.0L COYOTE FRONT COVER FOR SUPERCHARGED APPLICATIONS	M-6059-M50SC	101
5.0L COYOTE HEAD CHANGING KIT - 5.2L HEAD ON 5.0L BLOCK	M-6067-M5052	98
5.0L COYOTE HEAD CHANGING KIT-11MM HEAD BOLTS - 2015-2017	M-6067-M50	98
5.0L COYOTE HEAD CHANGING KIT-12MM HEAD BOLTS - 2019	M-6067-M5018	98
5.0L COYOTE HIGH RPM COMPETITION PULSE RING	M-12A227-CJ13	103
5.0L COYOTE HIGH STRENGTH VCT SOLENOIDS	M-6297-M50A	104
5.0L COYOTE LASH ADJUSTER ASSEMBLY KIT	M-6500-M50	99
5.0L COYOTE MOTOR MOUNT KIT	M-6038-M50	92
5.0L COYOTE MUSTANG FORGED CRANK	M-6303-M50B	92
5.0L COYOTE OIL PUMP INSTALLATION KIT	M-6600-A50PKIT	93
5.0L COYOTE ROLLER FINGER FOLLOWER KIT	M-6564-M50	100
5.0L COYOTE TIMING/FRONT COVER AND CAM COVER KIT	M-6580-M50	101
5.0L CRANKSHAFT DAMPER KIT	M-6316-M50	130
5.0L GEN 1 COYOTE PRODUCTION ENGINE BLOCK	M-6010-M504V	90
5.0L GEN 3 COYOTE PRODUCTION ENGINE BLOCK	M-6010-M504VC	90
5.0L TI-VCT BILLET STEEL GEROTOR OIL PUMP	M-6600-50CJ	93
5.0L/5.2L ALUMINUM CAM COVER-PAIR	M-6067-M52S	99
5.0L/5.2L BILLET STEEL GEROTOR OIL PUMP GEAR SET	M-6600-M50A	94
5.0L/5.2L COYOTE 12MM LONG HEAD BOLT KIT	M-6067-M501280	98
5.0L/5.2L COYOTE LOW VOLUME OIL PUMP	M-6600-50	93
5.0L/5.2L COYOTE OIL-AIR SEPARATOR RH	M-6766-A50	9
5.0L/5.2L HIGH STRENGTH FORGED STEEL CRANKSHAFT SPROCKET	M-6306-M50A	92
5.2L "GEN 2" HEAD CHANGING KIT	M-6067-M52B	98
5.2L "GEN 2" LH CYLINDER HEAD	M-6050-M52A	97
5.2L "GEN 2" RH CYLINDER HEAD	M-6049-M52A	97
5.2L "GEN 2" WATER PUMP KIT	M-8501-M52A	104
5.2L ALUMINATOR 5.2 XS CRATE ENGINE	M-6007-A52XS	84
5.2L COYOTE GT350 OIL PAN AND PUMP KIT	M-6675-M52	95
5.2L COYOTE HEAD CHANGING KIT	M-6067-M52	99
5.2L COYOTE ROLLER FINGER FOLLOWER KIT	M-6564-M52	100
5.2L COYOTE VALVE SPRING KIT	M-6513-M52	99
5.2L CYLINDER HEAD VALVE TRAIN KIT	M-6505-FP350S	104
5.2L GEN 2 COYOTE ALUMINUM ENGINE BLOCK	M-6010-M52A	90
5.2L GEN 3 COYOTE ALUMINUM ENGINE BLOCK	M-6010-M52B	90
5.2L GT350 CYLINDER HEAD LH	M-6050-M52	97
5.2L GT350 CYLINDER HEAD RH	M-6049-M52	97
5.2L GT350 OIL-AIR SEPARATOR LH	M-6766-A50S	10
5.2L GT500 OIL-AIR SEPARATOR RH	M-6766-A52	10
5.2L OIL SQUIRTER BLOCK OFF KIT	M-6868-M50	104
5.2L/5.0L MAIN BOLT KIT	M-6345-M52	92
5.3L MODULAR STROKER SHORT BLOCK	M-6009-B53	105
5.4L 4V CAMSHAFT DRIVE KIT	M-6004-A544	107
5.4L 4V MUSTANG SVT CAMSHAFT DRIVE KIT	M-6004-54SVT	107
5.4L 4V PERFORMANCE INTERCOOLER	M-6775-MSVT	38
5.4L 4V S/C HEAD CHANGING KIT	M-6067-MSVT	108
5.4L 4V STEEL TIMING CHAIN TENSIONER KIT	M-6266-M52	109
5.4L/5.8L TIMING COVER FOR S/C APPLICATIONS	M-6059-M54C	108
5.8L 4V S/C HEAD CHANGING KIT	M-6067-M58	108
572CI 655 HP BIG BLOCK STREET CRATE ENGINE-FRONT SUMP PAN	M-6007-572DF	145
572CI 655 HP BIG BLOCK STREET CRATE ENGINE-REAR SUMP PAN	M-6007-572DR	145
7.5" RING GEAR AND PINION INSTALLATION KIT	M-4210-B75	180
8.8" 3.08 RING GEAR AND PINION	M-4209-88308	178
8.8" 3.15 RING GEAR AND PINION	M-4209-88315	178
8.8" 3.27 RING GEAR AND PINION	M-4209-88327	178
8.8" 3.31 RING GEAR AND PINION	M-4209-88331	178
8.8" 3.55 RING GEAR AND PINION	M-4209-88355	178
8.8" 3.73 RING GEAR AND PINION	M-4209-88373	178
8.8" 4.10 RING GEAR AND PINION	M-4209-88410	178
8.8" 4.10 RING GEAR AND PINION FOR 4X4 FT AXLE	M-4209-88410F	179
8.8" 4.56 RING GEAR AND PINION	M-4209-88456	178
8.8" 4X4 FRONT 4.10 RING GEAR AND PINION	M-4209-88410F	70
8.8" ALUMINUM AXLE COVER WITH DIFFERENTIAL COOLER PORTS	M-4033-KA	178
8.8" AXLE BEARING AND SEAL KIT	M-1225-B1	179
8.8" AXLE GIRDLE COVER KIT	M-4033-G2	177
8.8" FRONT AXLE LIMITED SLIP TORSEN® DIFFERENTIAL	M-4204-F150LS	69
8.8" FRONT AXLE LIMITED SLIP TORSEN® DIFFERENTIAL	M-4204-F150LS	181
8.8" IRS BEARING AND SEAL KIT	M-4413-A	179
8.8" OUTER AXLE BEARING AND SEAL KIT	M-1225-B	179
8.8" RING & PINION INSTALLATION KIT	M-4210-A	180

PART DESCRIPTION	PART NUMBER	PAGE
8.8" RING AND PINION INSTALLATION KIT	M-4210-C3	180
8.8" RING GEAR AND PINION INSTALLATION KIT	M-4210-B2	180
8.8" RING GEAR BOLT SET	M-4216-A300	172
8.8" T-2 TORSEN DIFFERENTIALS	M-4204-T31	181
8.8" TRACTION-LOK LIMITED SLIP DIFFERENTIAL	M-4204-F318C	181
8.8" TRACTION-LOK REBUILD KIT	M-4700-B	180
8.8" TRACTION-LOK REBUILD KIT WITH CARBON DISCS	M-4700-C	181
9" DAYTONA PINION BEARING RETAINER	M-4614-B	183
9" DIFFERENTIAL BEARING ADJUSTER LOCK AND BOLT KIT	M-4144-B	182
9" STEEL DIFFERENTIAL CARRIER	M-4141-HS	182
9" TRAC-LOK LIMITED SLIP DIFFERENTIAL	M-4204-F28A	182
9" TRAC-LOK LIMITED SLIP DIFFERENTIAL	M-4204-F31A	182
9.75" F-150 RAPTOR DIFFERENTIAL COVER	M-4033-F975	181
9MM SPARK PLUG WIRE SETS - "FORD RACING"	M-12259-C301	144
9MM SPARK PLUG WIRE SETS - "FORD RACING"	M-12259-C302	144
9MM SPARK PLUG WIRE SETS - "FORD RACING"	M-12259-C460	150
9MM SPARK PLUG WIRE SETS - "FORD RACING"	M-12259-C462	111
9MM SPARK PLUG WIRE SETS - "FORD RACING"	M-12259-C464	111
9MM SPARK PLUG WIRE SETS - "FORD RACING"	M-12259-M301	144
9MM SPARK PLUG WIRE SETS - "FORD RACING"	M-12259-M302	144
9MM SPARK PLUG WIRE SETS - "FORD RACING"	M-12259-R301	144
9MM SPARK PLUG WIRE SETS - "FORD RACING"	M-12259-R460	150
9MM SPARK PLUG WIRE SETS - "FORD RACING"	M-12259-R462	111
9MM SPARK PLUG WIRE SETS - "FORD RACING"	M-12259-R464	111
9MM SPARK PLUG WIRE SETS - "FORD RACING"	M-12259-T462	111
A/C ELIMINATOR KIT, 1985-1993 MUSTANG	M-8511-A50	144
A/C ELIMINATOR KIT, 1994-1995 MUSTANG GT	M-19216-A50	143
A/C ELIMINATOR KIT, 1996-2010 MUSTANG	M-19216-D46	110
AIR CLEANER, SLANT EDGE FORD RACING	302-999	191
AIR FILTER ELEMENT	M-9601-C	37
AIR FILTER, 2015-2019 MUSTANG GT, I4 AND V6 HIGH-FLOW K&N / FORD PERFORMANCE	M-9601-M	11
AIR FILTER, 2015-2019 MUSTANG SHELBY GT350	M-9601-G	11
ALTERNATOR KIT, HIGH OUTPUT FOR COYOTE 5.0L	M-8600-M50ALTA	103
ALUMINUM AND URETHANE SPECIAL EDITION MUSTANG DEAD PEDAL - DEAD PEDAL	M-2301-C	52
ALUMINUM AND URETHANE SPECIAL EDITION MUSTANG PEDAL COVER - ACCELERATOR PEDAL COVER	M-2301-A	52
ALUMINUM AND URETHANE SPECIAL EDITION MUSTANG PEDAL COVER - BRAKE / CLUTCH PEDAL COVER	M-2301-B	52
ALUMINUM RADIATOR, 2005-2014 MUSTANG GT	M-8005-MGT	38
ANTI-ROLL BAR/SWAY BAR REPLACEMENT BUSHING KIT	M-5490-BKA	45
ANTI-ROLL BAR/SWAY BAR REPLACEMENT BUSHING KIT	M-5490-BKB	45
ANTI-ROLL BAR/SWAY BAR REPLACEMENT BUSHING KIT	M-5490-BKC	45
ANTI-ROLL BAR/SWAY BAR REPLACEMENT END LINK	M-5490-LINKA	46
ANTI-ROLL BAR/SWAY BAR REPLACEMENT END LINK	M-5490-LINKB	46
ANTI-ROLL BAR/SWAY BAR REPLACEMENT END LINK	M-5490-LINKC	46
ANTI-ROLL/SWAY BAR COMPLETE HARDWARE KIT	M-5490-HWA	46
ANTI-ROLL/SWAY BAR COMPLETE HARDWARE KIT	M-5490-HWB	46
ANTI-ROLL/SWAY BAR COMPLETE HARDWARE KIT	M-5490-HWC	46
AUTOMATIC IRS PINION FLANGE, 2015-2019 MUSTANG	M-4851-M8A	18
AXLE INSTALLATION KIT, 1979-2004 MUSTANG 8.8"	M-4050-B	178
BADGE - "POWERED BY FORD PERFORMANCE"	M-16098-PBFP	193
BADGE, CHROME V8	M-7843-V8	193
BANNER, "FORD PERFORMANCE"	M-1827-FP	194
BEAD LOCK RING KIT, 2013-2014 F-150 RAPTOR	M-1021-F15RA	74
BEAD LOCK RING KIT, 2017-2018 F-150 RAPTOR	M-1021-F15RB	74
BEAD LOCK RING KIT, 2019 RAPTOR	M-1021-RA1	74
BEAD LOCK WHEEL KIT, 2017-2018 F-150 RAPTOR	M-1007-W1785B	73
BEAD LOCK WHEEL TRIM RING - BLUE, 2017-2018 RAPTOR	M-1021-F15BL1	74
BEAD LOCK WHEEL TRIM RING - ORANGE, 2017-2018 RAPTOR	M-1021-F15OR1	74
BEAD LOCK WHEEL TRIM RING - RED, 2017-2018 RAPTOR	M-1021-F15RD1	74
BEAD LOCK WHEEL TRIM RING SET - BLUE, 2017-2018 RAPTOR	M-1021-F15BL	74
BEAD LOCK WHEEL TRIM RING SET - ORANGE, 2017-2018 RAPTOR	M-1021-F15OR	74
BEAD LOCK WHEEL TRIM RING SET - RED, 2017-2018 RAPTOR	M-1021-F15RD	74
BEAD-LOCK WHEEL KIT, 2019 F-150 RAPTOR	M-1007-DC1785A	74
BLACK FLOOR MATS "BOSS 302", 2013-14 MUSTANG	M-13086-MM	52
BLACK SATIN VALVE COVERS	M-6000-E302	189
BLACK SATIN VALVE COVERS	M-6000-J302R	190
BLACK SATIN VALVE COVERS	M-6582-C351BK	190
BLACK SATIN VALVE COVERS	M-6582-LE302BK	188
BLACK SATIN VALVE COVERS	M-6582-LE302SBK	188

PARTS INDEX (CONTINUED)

PART DESCRIPTION	PART NUMBER	PAGE
BLACK STAINLESS STEEL FORD PERFORMANCE LICENSE PLATE FRAME	M-1828-SS304BK	194
BOLT - 9" RING GEAR TO DIFFERENTIAL CASE (PACKAGE OF 10)	M-4216-A210	182
BOLT - 9" RING GEAR TO DIFFERENTIAL CASE (PACKAGE OF 100)	M-4216-A200	182
BOSS 302 ALTERNATOR KIT	M-8600-M50BALT	103
BOSS 302 ENGINE BLOCK	M-6010-BOSS302	128
BOSS 302 ENGINE BLOCK BIG BORE	M-6010-B302BB	128
BOSS 302 ENGINE OIL COOLER	M-6642-MB	93
BOSS 302 INTAKE MANIFOLD	M-9424-M50BR	100
BOSS 302 INTAKE MANIFOLD INSTALL KIT	M-9444-M50B	101
BOSS 302 MANUAL TRANS COOLER AIR SCOOP	M-5025-MBR	171
BOSS 302 OIL PICKUP TUBE	M-6622-BOSS302	131
BOSS 302R 5.0L POWER STEERING PUMP BRACKET	M-8511-M50BR	104
BOSS 302R DRIVESHAFT	M-4602-S	183
BOSS 302R ELECTRIC STEERING RACK	M-3200-EPAS	46
BOSS 302R HEAD CHANGING KIT - 11MM HEAD BOLTS	M-6067-M50BR11	98
BOSS 302R HEAD CHANGING KIT - 12MM HEAD BOLTS	M-6067-M50BR	98
BOSS 302R VALVE SPRING KIT	M-6513-M50BR	99
BOSS 302S FRONT SPLITTER HARDWARE KIT	M-16601H-S	50
BOSS 351 ENGINE BLOCK 9.2 DECK	M-6010-BOSS35192	128
BOSS 351 ENGINE BLOCK 9.2 DECK BIG BORE	M-6010-B35192BB	128
BOSS 351 ENGINE BLOCK 9.5 DECK BIG BORE	M-6010-BOSS351BB	128
BOSS 351 ENGINE BLOCK 9.5" DECK	M-6010-BOSS35195	128
BOSS BLOCK CYLINDER HEAD STUD KIT	M-6014-BOSS	129
BOSS BLOCK HEAD BOLT SET	M-6065-BOSS	130
BOSS INTAKE MANIFOLD/COYOTE ENGINE DRESS UP KIT	M-9680-BOSS	102
BRAKE DRUM, 11" X 2.25"	M-1126-B	49
BRAKE KIT, 2015-2019 MUSTANG PERFORMANCE GT350R	M-2300-Y	25
BRAKE KIT, S550 MUSTANG BULLITT™, 2015-2019	M-2300-BUL	25
BRAKE LINE UPGRADE KIT, 2005-2014 MUSTANG	M-2078-MB	50
BRAKE PROPORTIONING VALVE	M-2328-C	50
BRAKE UPGRADE KIT, 2005-2014 MUSTANG SIX PISTON 15-INCH	M-2300-T	49
BRAKE UPGRADE KIT, 2015-2019 GT350	M-2300-AA	24
BREATHER CAP W/ FORD RACING LOGO - BLACK	M-6766-FRNVBK	191
BREATHER CAP W/ FORD RACING LOGO - BLACK	M-6766-FRVBK	191
BREATHER CAP W/ FORD RACING LOGO - BLUE	M-6766-FRNVBL	191
BREATHER CAP W/ FORD RACING LOGO - BLUE	M-6766-FRVBL	191
BREATHER CAP W/ FORD RACING LOGO - CHROME	M-6766-FRNVCH	191
BREATHER CAP W/ FORD RACING LOGO - CHROME	M-6766-FRVCH	191
BRONZE VALVE GUIDE KIT	M-6510-XRBVG	135
BUMP STEER KIT, 2005-2014 MUSTANG	M-3130-R4	47
C4 A.T. DIPSTICK/TUBE	M-6750-D303	171
C6 A.T. DIPSTICK/TUBE	M-6750-E303	171
CALIBRATION AND SPARK PLUGS, 2013-2018 FOCUS ST	M-14204-FSTA	57
CALIBRATION, SPARK PLUGS AND COLD AIR INTAKE, 2013-2018 FOCUS ST	M-9603A-FSTA	57
CAM COVERS, BLACK FORD RACING COATED 3-VALVE	M-6582-FR3VBLK	112
CAM COVERS, BLUE FORD RACING COATED 3-VALVE	M-6582-FR3VBL	112
CAM SET FOR COYOTE 5.0L, 2012-2013 BOSS 302 EXHAUST	M-6550-M50BEXH	96
CAM SET FOR COYOTE 5.0L, 2012-2013 BOSS 302 INTAKE	M-6550-M50BINT	96
CAMSHAFT BEARINGS	M-6261-J351	129
CAMSHAFT BEARINGS - ROLLER (SOLD IN ENGINE SETS)	M-6261-A460	148
CAMSHAFT BEARINGS - ROLLER (SOLD IN ENGINE SETS)	M-6261-D351	129
CAMSHAFT DRIVE KIT, 2011-2014 5.0L 4V TI-VCT MUSTANG COYOTE	M-6004-A504	96
CAMSHAFT DRIVE KIT, 2015-2017 5.0L4V TI-VCT MUSTANG COYOTE	M-6004-A5015	96
CAMSHAFT DRIVE KIT, 2018 5.0L 4V TI-VCT MUSTANG COYOTE	M-6004-A5018	96
CAMSHAFT THRUST PLATE	M-6269-A351	130
CASTER AND CAMBER ALIGNMENT ECCENTRIC BOLT KIT, 2005-2014 MUSTANG	M-3B236-A	46
CHASE RACK IN-BED TIRE CARRIER, 2017-2019 RAPTOR	M-19007-BC	72
CHASE RACK WITH LIGHT BAR ACTUATOR, 2017-2019 RAPTOR/F-150 RACE SERIES REAR	M-19007-A	72
CHASE RACK, 2017-2019 SUPER DUTY FORD PERFORMANCE	M-19007-SD	72
CHASE RACK, 2019 RANGER FORD PERFORMANCE	M-19007-R	75
CHASE RACK, F-150/RAPTOR FORD PERFORMANCE	M-19007-F15R	72
CHASE RACK/ROOF RACK, 2017-2019 RAPTOR	M-19007-B	72
CLUTCH ADJUSTER, 1979-2004 V6 AND V8 MUSTANG TOPSIDE	M-7554-A	177

PART DESCRIPTION	PART NUMBER	PAGE
CLUTCH CABLE, 1996-2004 V8 MUSTANG ADJUSTABLE	M-7553-E302	177
CLUTCH DISC	M-7550-X302	176
CLUTCH FLUID LINE UPGRADE, 2015-2019 MUSTANG HIGH PERFORMANCE	M-7512-B	17
CLUTCH KIT	M-7560-A302N	176
CLUTCH KIT	M-7560-T46	176
CLUTCH LINKAGE KIT, 1982-1995 V8 MUSTANG ADJUSTABLE	M-7553-B302	177
CLUTCH LINKAGE KIT, 1996-2004 V8 MUSTANG ADJUSTABLE	M-7553-D302	177
CLUTCH LINKAGE UPGRADE KIT, 1979-1993 V8 MUSTANG	M-7553-A302	177
CLUTCH QUADRANT, 1982-2004 V8 MUSTANG DOUBLE-HOOK	M-7583-A	177
CLUTCH RELEASE LEVER, 1996-2004 MUSTANG	M-7515-A	177
CLUTCH SERVICE CABLE, 1982-1995 V8 MUSTANG ADJUSTABLE	M-7553-C302	177
COBRA JET AIR INLET, 2016	M-9600-SCJ16	9
COIL COVERS, 2007-2014 MUSTANG SVT	M-6067-C	112
COLD AIR AND SUPERCHARGER UPGRADE KIT REPLACEMENT AIR FILTER, 2007-2009 MUSTANG SVT	M-9601-D	37
COLD AIR INTAKE (NO CAL), 2015-2017 MUSTANG 2.3L	M-9603-M23	9
COLD AIR INTAKE AND CALIBRATION POWER PACK 2, 2015-2017 MUSTANG GT	M-9603-M8A	8
COLD AIR INTAKE AND THROTTLE BODY (NO CAL), 2015-2017 MUSTANG 5.0L	M-9603-M50	9
COLD AIR INTAKE KIT, 2013-2018 FOCUS ST	M-9603-FST	57
COLD AIR KIT WITH PERFORMANCE CALIBRATION, 2005-2009 MUSTANG V6	M-9603-V605	37
COLD AIR TUNER KIT (CALIBRATION REQUIRED), 2005-2009 MUSTANG V6 4.0L	M-9603-M40	36
COLD SPARK PLUG SET, 2010-2019 3.5L ECOBOOST®	M-12405-35T	94
COLD SPARK PLUG SET, 2013-2018 FOCUS ST/RS/MUSTANG ECOBOOST	M-12405-20T	57
COMPETITION FRONT BUSHING KIT, 2005-2014 MUSTANG	M-5638-C	47
COMPLETE LOWERING KIT, 2015-2019 F-150	M-3000-H4A	69
CONTROL PACK - 2011-2014 COYOTE 5.0L 4V MANUAL TRANS WITH SPEED DIAL	M-6017-A504VB	85
CONTROL PACK - 2013-2016 3.5L ECOBOOST MANUAL TRANSMISSION	M-6017-35CNTRL	161
CONTROL PACK - 2015-2017 COYOTE 5.0L MANUAL TRANSMISSION	M-6017-504V	163
CONTROL PACK - 2015-2017 COYOTE 5.0L WITH AUTOMATIC TRANSMISSION	M-6017-M50A	162
CONTROL PACK - 2018 COYOTE 5.0L MANUAL TRANSMISSION	M-6017-M50B	85
CONTROL PACK-AUTOMATIC TRANSMISSION, 2018-2019 GEN 3 COYOTE	M-6017-M50BA	161
COYOTE ENGINE AUTOMATIC TRANSMISSION UPFIT KIT	M-12000-M50A	94
COYOTE ENGINE MANUAL TRANSMISSION UPFIT KIT	M-12000-M50	94
CRANKSHAFT DAMPER	M-6316-A460	148
CRANKSHAFT DAMPER	M-6316-A50	130
CRANKSHAFT DAMPER	M-6316-A52I	148
CRANKSHAFT DAMPER	M-6316-C35I	130
CRANKSHAFT RAW FORGING, COYOTE	M-6303-M50RF	92
CRANKSHAFT, 2015-2018 2.3L ECOBOOST	M-6303-23EB	114
CRANKSHAFT, COYOTE 5.2L FORGED	M-6303-M52	92
CRANKSHAFT, HIGH STRENGTH FORGED STEEL 3.40" STROKER	M-6303-C340	130
CROSSMEMBER, ADJUSTABLE #3	M-5059-A	171
CUSTOM BILLET WIRE LOOMS	M-12297-L900	192
CYLINDER HEAD GASKET	M-6051-A302	140
CYLINDER HEAD GASKET	M-6051-A44I	140
CYLINDER HEAD GASKET	M-6051-A44I	147
CYLINDER HEAD GASKET	M-6051-B34I	140
CYLINDER HEAD GASKET	M-6051-B460	147
CYLINDER HEAD GASKET	M-6051-R35I	140
CYLINDER HEAD STUD KIT	M-6014-Z304	129
CYLINDER HEAD, 2015-2018 MUSTANG 2.3L ECOBOOST	M-6049-M23	114
CYLINDER SLEEVE SET FOR M-6010-Z351 BLOCK	M-6012-C35I	126
CYLINDER SLEEVE SET FOR M-6010-Z35192 BLOCK	M-6012-C35192	126
DASH EMBLEM, 2015-2019, "FORD PERFORMANCE"	M-1447-A	193
DECAL - 10 PACK, "FORD PERFORMANCE"	M-1820-FP	194
DECK LID TRIM PANEL, 2015-2019 MUSTANG	M-16600-MA	26
DE-GAS BOTTLE, 2005-2010 MUSTANG GT	M-8080-A	39
DIFFERENTIAL COVER KIT, RANGER FORD PERFORMANCE	M-4033-R	74
DIGITAL PERFORMANCE INFORMATION CENTER GAUGE	M-6304-DPIC	187
DISTRIBUTOR HOLD-DOWN CLAMP	M-12270-A302	192
DRIFT STICK, 2016-2018 FOCUS RS	M-2780-FRS	59
DRIVESHAFT ASSEMBLY - 28 SPLINE, HD ALUMINUM	M-4602-GA	183
DRIVESHAFT ASSEMBLY - 31 SPLINE, HD ALUMINUM	M-4602-JA	183
DRIVESHAFT LOOP, 2015-2019 MUSTANG	M-5478-6M	24
DRIVESHAFT LOOP, COBRA JET	M-5478-CJ	184

PART DESCRIPTION	PART NUMBER	PAGE
DRIVESHAFT SLIP YOKE, 28 SPLINE	M-4841-B	183
DRIVESHAFT YOKE 31 SPLINE	M-4841-A	183
DRIVESHAFT, 2005-2010 MUSTANG GT ONE-PIECE	M-4602-MGTA	183
DRIVESHAFT, 2007-2012 MUSTANG GT500 ONE-PIECE	M-4602-MSVT	183
DRIVESHAFT, 2011-2014 MUSTANG GT ONE-PIECE	M-4602-MGTM	183
DUAL EXHAUST KIT, 2005-2009 MUSTANG V6 TOURING	M-5230-V6	41
ECOBOOST EMBLEMS/BADGES-BLACK AND CHROME-LARGE SIZE-PAIR	M-1447-EBBLKLG	193
ECOBOOST EMBLEMS/BADGES-BLACK AND SILVER-PAIR	M-1447-EBBLK	193
ECOBOOST EMBLEMS/BADGES-SILVER-LARGE SIZE-PAIR	M-1447-EBLG	193
EFI HEAT SPACER .5" COBRA INTAKE	M-9486-A52	142
EFI HEAT SPACER .5" STOCK 5.0L INTAKE	M-9486-A51	142
EFI HEAT SPACER 1.00" COBRA INTAKE	M-9486-A53	142
EFI UPPER-TO-LOWER INTAKE MANIFOLD GASKET	M-9486-A50	142
ELECTRIC WATER PUMP KIT FOR COYOTE 5.0L	M-8501-M50CJ16	103
ENGINE BLOCK THREADED CORE PLUGS	M-6026-B302	129
ENGINE BLOCK, 1.6 LITER 4-CYLINDER KENT	M-6010-16K	151
ENGINE BLOCK, 1.6 LITER 4-CYLINDER LOTUS	M-6010-16L	151
ENGINE BLOCK-CAMSHAFT PLUG KIT, FORD PERFORMANCE	M-6026-S351	129
ENGINE CAP SET W/ LASER ENGRAVED "FORD PERFORMANCE" LOGO, 2015-2019 MUSTANG BILLET	M-6766-M50A	27
ENGINE CAP SET, 2010-2014 MUSTANG 5.0 BILLET	M-6766-M50B	52
ENGINE COVER KIT, 2011-2014 5.0L COYOTE "GEN 1"	M-9680-M50	102
ENGINE COVER KIT, 2015-2017 MUSTANG GT COYOTE	M-9680-M50A	102
ENGINE COVER KIT, 2018-2019 MUSTANG GT COYOTE	M-9680-M50B	27
ENGINE DRESS UP KIT, 2018-2019 COYOTE	M-9680-M50BA	27
ENGINE GASKET SET, HI-PERFORMANCE	M-6003-A429	147
ENGINE GASKET SET, HI-PERFORMANCE	M-6003-A50	139
ENGINE MOUNT BRACKET KIT	M-6031-BOSS50	106
ENGINE OIL DIPSTICK/TUBE	M-6750-C303	133
ENGINE SWAP ACCESSORY DRIVE KITS, 1985-1993 MUSTANG 351W	M-8511-A351	144
ENGINE SWAP ACCESSORY DRIVE KITS, 1985-1993 MUSTANG 351W	M-8511-B351	144
ENGINE SWAP MOUNTS, 1979-1995 460 FOX	M-6038-A460	146
EXHAUST MANIFOLD GASKETS	M-9448-A462	110
EXHAUST MANIFOLD GASKETS	M-9448-A464	110
EXHAUST MANIFOLD GASKETS	M-9448-B302	141
EXHAUST MANIFOLDS, 2011-2019 5.0L COYOTE STREET ROD CAST IRON	M-9430-SR50A	79
EXHAUST SYSTEM - 145" WB, 2011-2014 F-150 RAPTOR 6.2L CAT-BACK SPORT	M-5200-F15R145L	68
EXHAUST SYSTEM - 145" WB, 2011-2014 F-150 3.5L ECOBOOST CAT-BACK SPORT	M-5200-F1535145L	68
EXHAUST SYSTEM - 145" WB, 2011-2014 F-150 5.0L COYOTE CAT-BACK SPORT	M-5200-F1550145L	68
EXHAUST SYSTEM - 145" WB, 2011-2014 F-150 5.0L COYOTE CAT-BACK TOURING	M-5200-F1550145C	68
EXHAUST SYSTEM - 145" WB, 2011-2014 F-150 RAPTOR 6.2L CAT-BACK TOURING	M-5200-F15R145C	68
EXHAUST SYSTEM - BLACK CHROME TIPS, 2015-2017 MUSTANG GT 5.0L CAT BACK SPORT	M-5200-M8SB	11
EXHAUST SYSTEM - BLACK CHROME TIPS, 2015-2017 MUSTANG GT 5.0L CAT BACK TOURING	M-5200-M8TB	12
EXHAUST SYSTEM - BLACK CHROME TIPS, 2015-2019 MUSTANG 2.3L ECOBOOST CAT BACK EXTREME	M-5200-M4EBA	14
EXHAUST SYSTEM - BLACK CHROME TIPS, 2015-2019 MUSTANG 2.3L ECOBOOST CAT BACK SPORT	M-5200-M4SBA	14
EXHAUST SYSTEM - BLACK CHROME TIPS, 2015-2019 MUSTANG 2.3L ECOBOOST CAT BACK TOURING	M-5200-M4TBA	14
EXHAUST SYSTEM - BLACK CHROME TIPS, 2018-2019 MUSTANG GT 5.0L CAT BACK EXTREME	M-5200-M8EBA	14
EXHAUST SYSTEM - BLACK CHROME TIPS, 2018-2019 MUSTANG GT 5.0L CAT BACK SPORT	M-5200-M8SBA	14
EXHAUST SYSTEM - BLACK CHROME TIPS, 2018-2019 MUSTANG GT 5.0L CAT BACK TOURING	M-5200-M8TBA	14
EXHAUST SYSTEM - BLACK TIPS, 2017-2019 F-150 RAPTOR 3.5L CAT BACK SPORT	M-5200-F15RSB	67
EXHAUST SYSTEM - BLACK TIPS, 2017-2019 F-150 RAPTOR 3.5L CAT BACK TOURING	M-5200-F15RTB	67
EXHAUST SYSTEM - CARBON FIBER TIPS, 2015-2019 MUSTANG 2.3L ECOBOOST CAT BACK EXTREME	M-5200-M4EFA	14
EXHAUST SYSTEM - CARBON FIBER TIPS, 2015-2019 MUSTANG 2.3L ECOBOOST CAT BACK SPORT	M-5200-M4SFA	14
EXHAUST SYSTEM - CARBON FIBER TIPS, 2015-2019 MUSTANG 2.3L ECOBOOST CAT BACK TOURING	M-5200-M4TFA	14
EXHAUST SYSTEM - CARBON FIBER TIPS, 2017-2019 F-150 RAPTOR 3.5L CAT BACK SPORT	M-5200-F15RSCF	67
EXHAUST SYSTEM - CARBON FIBER TIPS, 2017-2019 F-150 RAPTOR 3.5L CAT BACK TOURING	M-5200-F15RTC	67

PART DESCRIPTION	PART NUMBER	PAGE
EXHAUST SYSTEM - CARBON FIBER TIPS, 2018-2019 MUSTANG GT 5.0L CAT BACK EXTREME	M-5200-M8EFA	14
EXHAUST SYSTEM - CARBON FIBER TIPS, 2018-2019 MUSTANG GT 5.0L CAT BACK SPORT	M-5200-M8SFA	14
EXHAUST SYSTEM - CARBON FIBER TIPS, 2018-2019 MUSTANG GT 5.0L CAT BACK TOURING	M-5200-M8TFA	14
EXHAUST SYSTEM - CHROME TIPS, 2015-2017 MUSTANG GT 5.0L CAT BACK SPORT	M-5200-M8SC	11
EXHAUST SYSTEM - CHROME TIPS, 2015-2017 MUSTANG GT 5.0L CAT BACK TOURING	M-5200-M8TC	12
EXHAUST SYSTEM - CHROME TIPS, 2015-2019 MUSTANG 2.3L ECOBOOST CAT BACK EXTREME	M-5200-M4ECA	14
EXHAUST SYSTEM - CHROME TIPS, 2015-2019 MUSTANG 2.3L ECOBOOST CAT BACK SPORT	M-5200-M4SCA	14
EXHAUST SYSTEM - CHROME TIPS, 2015-2019 MUSTANG 2.3L ECOBOOST CAT BACK TOURING	M-5200-M4TCA	14
EXHAUST SYSTEM - CHROME TIPS, 2017-2019 F-150 RAPTOR 3.5L CAT BACK SPORT	M-5200-F15RSC	67
EXHAUST SYSTEM - CHROME TIPS, 2017-2019 F-150 RAPTOR 3.5L CAT BACK TOURING	M-5200-F15RTC	67
EXHAUST SYSTEM - CHROME TIPS, 2018-2019 MUSTANG GT 5.0L CAT BACK EXTREME	M-5200-M8ECA	14
EXHAUST SYSTEM - CHROME TIPS, 2018-2019 MUSTANG GT 5.0L CAT BACK SPORT	M-5200-M8SCA	14
EXHAUST SYSTEM - CHROME TIPS, 2018-2019 MUSTANG GT 5.0L CAT BACK TOURING	M-5200-M8TCA	14
EXHAUST SYSTEM - REAR EXIT, BLACK CHROME TIPS, 2015-2019 F-150 2.7L CAT-BACK EXTREME	M-5200-F1527DEBA	66
EXHAUST SYSTEM - REAR EXIT, BLACK CHROME TIPS, 2015-2019 F-150 2.7L CAT-BACK SPORT	M-5200-F1527DSBA	66
EXHAUST SYSTEM - REAR EXIT, BLACK CHROME TIPS, 2015-2019 F-150 2.7L CAT-BACK TOURING	M-5200-F1527DTBA	66
EXHAUST SYSTEM - REAR EXIT, BLACK CHROME TIPS, 2015-2019 F-150 3.5L CAT-BACK EXTREME	M-5200-F1535DEBA	66
EXHAUST SYSTEM - REAR EXIT, BLACK CHROME TIPS, 2015-2019 F-150 3.5L CAT-BACK SPORT	M-5200-F1535DSBA	66
EXHAUST SYSTEM - REAR EXIT, BLACK CHROME TIPS, 2015-2019 F-150 3.5L CAT-BACK TOURING	M-5200-F1535DTBA	66
EXHAUST SYSTEM - REAR EXIT, BLACK CHROME TIPS, 2015-2019 F-150 5.0L CAT-BACK EXTREME	M-5200-F1550DEBA	66
EXHAUST SYSTEM - REAR EXIT, BLACK CHROME TIPS, 2015-2019 F-150 5.0L CAT-BACK SPORT	M-5200-F1550DSBA	66
EXHAUST SYSTEM - REAR EXIT, BLACK CHROME TIPS, 2015-2019 F-150 5.0L CAT-BACK TOURING	M-5200-F1550DTBA	66
EXHAUST SYSTEM - REAR EXIT, CARBON FIBER TIPS 2015-2019 F-150 2.7L CAT-BACK SPORT	M-5200-F1527DSFA	66
EXHAUST SYSTEM - REAR EXIT, CARBON FIBER TIPS, 2015-2019 F-150 2.7L CAT-BACK EXTREME	M-5200-F1527DEFA	66
EXHAUST SYSTEM - REAR EXIT, CARBON FIBER TIPS, 2015-2019 F-150 2.7L CAT-BACK TOURING	M-5200-F1527DTFA	66
EXHAUST SYSTEM - REAR EXIT, CARBON FIBER TIPS, 2015-2019 F-150 3.5L CAT-BACK EXTREME	M-5200-F1535DEFA	66
EXHAUST SYSTEM - REAR EXIT, CARBON FIBER TIPS, 2015-2019 F-150 3.5L CAT-BACK SPORT	M-5200-F1535DSFA	66
EXHAUST SYSTEM - REAR EXIT, CARBON FIBER TIPS, 2015-2019 F-150 3.5L CAT-BACK TOURING	M-5200-F1535DTFA	66
EXHAUST SYSTEM - REAR EXIT, CARBON FIBER TIPS, 2015-2019 F-150 5.0L CAT-BACK EXTREME	M-5200-F1550DEFA	66
EXHAUST SYSTEM - REAR EXIT, CARBON FIBER TIPS, 2015-2019 F-150 5.0L CAT-BACK SPORT	M-5200-F1550DSFA	66
EXHAUST SYSTEM - REAR EXIT, CARBON FIBER TIPS, 2015-2019 F-150 5.0L CAT-BACK TOURING	M-5200-F1550DTFA	66
EXHAUST SYSTEM - REAR EXIT, CHROME TIPS, 2015-2019 F-150 2.7L CAT-BACK SPORT	M-5200-F1527DSCA	66
EXHAUST SYSTEM - REAR EXIT, CHROME TIPS, 2015-2019 F-150 2.7L CAT-BACK TOURING	M-5200-F1527DTCA	66
EXHAUST SYSTEM - REAR EXIT, CHROME TIPS, 2015-2019 F-150 3.5L CAT-BACK EXTREME	M-5200-F1535DECA	66
EXHAUST SYSTEM - REAR EXIT, CHROME TIPS, 2015-2019 F-150 3.5L CAT-BACK SPORT	M-5200-F1535DSCA	66
EXHAUST SYSTEM - REAR EXIT, CHROME TIPS, 2015-2019 F-150 3.5L CAT-BACK TOURING	M-5200-F1535DTCA	66
EXHAUST SYSTEM - REAR EXIT, CHROME TIPS, 2015-2019 F-150 5.0L CAT-BACK EXTREME	M-5200-F1550DECA	66
EXHAUST SYSTEM - REAR EXIT, CHROME TIPS, 2015-2019 F-150 5.0L CAT-BACK SPORT	M-5200-F1550DSCA	66
EXHAUST SYSTEM - REAR EXIT, CHROME TIPS, 2015-2019 F-150 5.0L CAT-BACK TOURING	M-5200-F1550DTCA	66
EXHAUST SYSTEM - SIDE EXIT WITH DUAL BLACK-CHROME TIPS, 2019 RANGER 2.3L FORD PERFORMANCE SPORT	M-5200-RA23SB	74
EXHAUST SYSTEM - SIDE EXIT WITH DUAL CHROME TIPS, 2019 RANGER 2.3L FORD PERFORMANCE SPORT	M-5200-RA23SC	74
EXHAUST SYSTEM - SIDE EXIT, BLACK CHROME TIPS, 2015-2019 F-150 2.7L CAT-BACK EXTREME	M-5200-F1527REBA	66

PART DESCRIPTION	PART NUMBER	PAGE
EXHAUST SYSTEM - SIDE EXIT, BLACK CHROME TIPS, 2015-2019 F-150 2.7L CAT-BACK SPORT	M-5200-F1527RSBA	66
EXHAUST SYSTEM - SIDE EXIT, BLACK CHROME TIPS, 2015-2019 F-150 2.7L CAT-BACK TOURING	M-5200-F1527RTBA	66
EXHAUST SYSTEM - SIDE EXIT, BLACK CHROME TIPS, 2015-2019 F-150 3.5L CAT-BACK EXTREME	M-5200-F1535REBA	66
EXHAUST SYSTEM - SIDE EXIT, BLACK CHROME TIPS, 2015-2019 F-150 3.5L CAT-BACK SPORT	M-5200-F1535RSBA	66
EXHAUST SYSTEM - SIDE EXIT, BLACK CHROME TIPS, 2015-2019 F-150 3.5L CAT-BACK TOURING	M-5200-F1535RTBA	66
EXHAUST SYSTEM - SIDE EXIT, BLACK CHROME TIPS, 2015-2019 F-150 5.0L CAT-BACK EXTREME	M-5200-F1550REBA	66
EXHAUST SYSTEM - SIDE EXIT, BLACK CHROME TIPS, 2015-2019 F-150 5.0L CAT-BACK SPORT	M-5200-F1550RSBA	66
EXHAUST SYSTEM - SIDE EXIT, BLACK CHROME TIPS, 2015-2019 F-150 5.0L CAT-BACK TOURING	M-5200-F1550RTBA	66
EXHAUST SYSTEM - SIDE EXIT, CHROME TIPS, 2014 F-150 TREMOR 3.5L CAT-BACK SPORT	M-5200-F1535126L	68
EXHAUST SYSTEM - SIDE EXIT, CHROME TIPS, 2015-2019 F-150 2.7L CAT-BACK EXTREME	M-5200-F1527RECA	66
EXHAUST SYSTEM - SIDE EXIT, CHROME TIPS, 2015-2019 F-150 2.7L CAT-BACK SPORT	M-5200-F1527RSCA	66
EXHAUST SYSTEM - SIDE EXIT, CHROME TIPS, 2015-2019 F-150 3.5L CAT-BACK EXTREME	M-5200-F1535RECA	66
EXHAUST SYSTEM - SIDE EXIT, CHROME TIPS, 2015-2019 F-150 3.5L CAT-BACK SPORT	M-5200-F1535RSCA	66
EXHAUST SYSTEM - SIDE EXIT, CHROME TIPS, 2015-2019 F-150 3.5L CAT-BACK TOURING	M-5200-F1535RTCA	66
EXHAUST SYSTEM - SIDE EXIT, CHROME TIPS, 2015-2019 F-150 5.0L CAT-BACK EXTREME	M-5200-F1550RECA	66
EXHAUST SYSTEM - SIDE EXIT, CHROME TIPS, 2015-2019 F-150 5.0L CAT-BACK SPORT	M-5200-F1550RSCA	66
EXHAUST SYSTEM - SIDE EXIT, CHROME TIPS, 2015-2019 F-150 5.0L CAT-BACK TOURING	M-5200-F1550RTCA	66
EXHAUST SYSTEM - SIDE EXIT, CHROME TIPS 2015-2019 F-150 2.7L CAT-BACK TOURING	M-5200-F1527RTCA	66
EXHAUST SYSTEM KIT WITH GT350 EXHAUST TIPS & LOWER VALANCE, 2015-2017 MUSTANG GT 5.0L CAT BACK	M-5200-M8SBV	12
EXHAUST SYSTEM KIT WITH GT350 EXHAUST TIPS & LOWER VALANCE, 2015-2017 MUSTANG GT 5.0L CAT BACK ACTIVE	M-5200-M8	11
EXHAUST SYSTEM MID-PIPE, 2017-2018 F-150 RAPTOR 3.5L ECOBOOST 133-INCH WHEELBASE	M-5248-F15R133	67
EXHAUST SYSTEM WITH GT350 EXHAUST TIPS & LOWER VALANCE, 2015-2017 MUSTANG 2.3L CAT BACK SPORT	M-5200-M4SBV	15
EXHAUST SYSTEM WITH GT350 EXHAUST TIPS & LOWER VALANCE, 2015-2017 MUSTANG 2.3L CAT BACK TOURING	M-5200-M4TBV	15
EXHAUST SYSTEM WITH GT350 TIPS AND LOWER VALANCE, 2015-2017 MUSTANG 5.0L CAT-BACK TOURING	M-5200-M8TBV	12
EXHAUST SYSTEM WITH REAR FASCIA, 2012-2014 FOCUS HATCHBACK ST	M-5230-FSHA	58
EXHAUST SYSTEM, 2010-2018 TAURUS SHO CAT-BACK TOURING	M-5200-SHOTC	59
EXHAUST SYSTEM, 2011-2014 MUSTANG GT & 2011-2012 GT500 3-INCH	M-5230-MGTCA30	40
EXHAUST SYSTEM, 2012-2018 FOCUS HATCHBACK AXLE BACK	M-5230-FSH	58
EXHAUST SYSTEM, 2013-2018 FOCUS ST CAT-BACK SPORT	M-5200-FST	58
EXHAUST SYSTEM, 2015-2019 MUSTANG GT 5.0L SIDE EXIT	M-5220-M8	13
EXHAUST SYSTEM, 2015-2019 MUSTANG GT350 ACTIVE CAT BACK SPORT	M-5200-MSS	11
EXHAUST SYSTEM, 2016-2018 FOCUS RS ACTIVE CAT BACK SPORT	M-5200-FRS	58
EXHAUST VALVE	M-6505-A429	147
EXHAUST VALVE	M-6505-G302	135
EXHAUST VALVE 302/351W	M-6505-B304	136
EXHAUST VALVE 7MM	M-6505-D3047	136
EXHAUST VALVE LIGHTWEIGHT 5.2L COYOTE - QTY 8	M-6505-M52	99
EXTENDED ARP WHEEL STUD KIT, 2015-2019 MUSTANG	M-1107-C	18
FENDER COVER, "FORD PERFORMANCE"	M-1822-A7	193
FENDER COVERS (PAIR), 2015-2017 MUSTANG	M-1822-M	29
FENDER EMBLEMS, 1994-2004 COBRA SNAKE	M-1447-SR	192
FENDER EMBLEMS, 2007-2009 MUSTANG SVT 'COBRA' SNAKE	M-1447-C	192
FENDER EMBLEMS/BADGES-BLACK-PAIR, 2015-2019 MUSTANG 5.0L	M-1447-M50AB	192
FENDER EMBLEMS/BADGES-CHROME-PAIR, 2011-2014 MUSTANG 5.0L	M-1447-M50	192
FENDER EMBLEMS/BADGES-CHROME-PAIR, 2015-2019 MUSTANG 5.0L	M-1447-M50A	192
FLOOR MAT SILVER PONY, 2010 MUSTANG BLACK	M-13086-MF	52
FLOOR MAT SILVER PONY, 2013-14 MUSTANG BLACK	M-13086-MN	52
FLOOR MATS "BOSS 302", 2012 MUSTANG BLACK	M-13086-MJ	52
FLOOR MATS "GT500", 2013-14 MUSTANG GRAY	M-13086-MP	52
FLOOR MATS "MUSTANG" TAG, 2006-09 MUSTANG BLACK	M-13086-ME	52
FLOOR MATS "MUSTANG" TAG, 2006-09 MUSTANG GRAY	M-13086-MD	52

PART DESCRIPTION	PART NUMBER	PAGE
FLOOR MATS SILVER PONY, 2012 MUSTANG BLACK	M-13086-MH	52
FLOOR MATS, 2010 MUSTANG GT500 GRAY	M-13086-MG	52
FLYWHEEL, LIGHT WEIGHT BILLET 8 BOLT MODULAR-COYOTE	M-6375-M50	175
FOG LIGHT KIT, 2017-2019 RAPTOR SAE LED	M-15200-RFL	73
FORD GT BATTERY CHARGER KIT-EU SPEC	M-10665-C	195
FORD GT BATTERY CHARGER KIT-UK SPEC	M-10665-B	195
FORD GT BATTERY CHARGER KIT-US SPEC	M-10665-A	195
FORD PERFORMANCE 10' x 20' E-Z UP TENT	M-1827-T20A	195
FORD PERFORMANCE 10'X10' E-Z UP TENT	M-1827-T10A	195
FORD PERFORMANCE 5.0 SMART BATTERY CHARGER & MAINTAINER	M-10300-FP	194
FORD PERFORMANCE 5.0 SMART BATTERY CHARGER COVER	M-10300-COVER	195
FORD PERFORMANCE BY BORLA GT FORWARD RESONATOR/MUFFLER, 2015-2019 MUSTANG GT	M-5231-M8	16
FORD PERFORMANCE CALIBRATION WITH HIGH FLOW K&N AIR FILTER, 2011-2014 MUSTANG GT	M-9603-MGTB	36
FORD PERFORMANCE E-Z UP TENT SIDE WALLS 10'	M-1827-W10A	195
FORD PERFORMANCE MUSTANG DASH GAUGE POD	M-6304GPOD-A	187
FORD PERFORMANCE RADIATOR COVER, 2015-2017 MUSTANG	M-8291-FP	10
FORD RACING COMPETITION GAUGES - FUEL PRESSURE	M-9275-BFSE	187
FORD RACING COMPETITION GAUGES - OIL PRESSURE	M-9278-BFSE	187
FORD RACING COMPETITION GAUGES - WATER TEMP	M-10883-BFSE	187
FORD RACING MUSTANG GAUGE PACK	M-6304GPACK-MA	187
FR3 TRACK SUSPENSION SINGLE FRONT SERVICE STRUT, 2015-2019 MUSTANG	M-18001-AG	19
FR3 TRACK SUSPENSION SINGLE REAR SERVICE SHOCK, 2015-2019 MUSTANG	M-18001-AS	19
FR9 NASCAR CYLINDER HEAD	M-6049-E1	152
FR9 NASCAR ENGINE BLOCK	M-6010-R500	152
FR9 NASCAR INTAKE MANIFOLD FUEL INJECTED	M-9424-E554	153
FR9 NASCAR INTAKE MANIFOLD NATIONWIDE AND TRUCK SERIES	M-9424-E651	153
FR9 WATER OUTLET MANIFOLD	M-8C368-FR9	153
FR9 WATER PUMP ASSEMBLY	M-8501-FR9	153
FRICTION MODIFIER FOR CLUTCH-TYPE LIMITED-SLIP DIFFERENTIALS (CASE OF 12 BOTTLES)	M-19546-A12	181
FRICTION MODIFIER FOR CLUTCH-TYPE LIMITED-SLIP DIFFERENTIALS (SINGLE BOTTLES)	CM-19546-A1	181
FRONT & REAR SHOCK UPGRADE KIT, 2017-2018 RAPTOR FOX FACTORY RACE SERIES 3.0	M-18000-F15R	70
FRONT AXLE KNUCKLE SEAL SHIELD, 2005-2016 4X4 SUPER DUTY	M-B10677-AA	184
FRONT BRAKE COOLING DEFLECTOR KIT, 2013-2018 FOCUS ST	M-2004-FRS	61
FRONT BRAKE KIT, 2015-2019 MUSTANG PERFORMANCE PACK 6-PISTON	M-2300-V	25
FRONT BRAKE UPGRADE KIT, 1994-2004 MUSTANG COBRA R	M-2300-X	49
FRONT BRAKE UPGRADE KIT, 2005-2010 MUSTANG V6	M-2300-D	48
FRONT BRAKE UPGRADE M-2300-X BRAKE PAD REPLACEMENT KIT, 1994-2004 FORD PERFORMANCE COBRA R	M-2300-XP	49
FRONT BRAKE UPGRADE M-2300-X BRAKE ROTOR REPLACEMENT KIT, 1994-2004 FORD PERFORMANCE COBRA R	M-2300-XR	49
FRONT BUMPER, 2005-2014 MUSTANG LIGHT WEIGHT TUBULAR	M-17757-MB	51
FRONT CONTROL ARM KIT W/ EXTENDED BALL JOINT , 2011-2014 MUSTANG	M-3075-RA	46
FRONT CONTROL ARM KIT, 2015-2019 MUSTANG PERFORMANCE PACK	M-3075-F	21
FRONT GRILLE, 2012 MUSTANG BOSS 302S	M-8200-MBR	51
FRONT LOWER A-ARM BRACE UPGRADE KIT, 2005-2009 MUSTANG GT COUPE	M-5025-A	47
FRONT LOWER CONTROL ARM KIT, 1979-1993 MUSTANG / CAPRI	M-3075-A	47
FRONT LOWER CONTROL ARM UPGRADE KIT, 2005-2010 MUSTANG GT	M-3075-E	46
FRONT SPLITTER KIT, 2013-2014 BOSS LAGUNA SECA	M-16601-MBA	50
FRONT STRUT MOUNT (PAIR), 2015-2019 MUSTANG	M-18183-M	20
FRONT STRUT MOUNT UPGRADE (PAIR), 2005-2014 MUSTANG	M-18183-C	44
FRONT TIMING COVER, 289/302/351W SHORT SERPENTINE BELT	M-6059-A50	142
FRONT WHEEL HUB KIT WITH ARP STUDS, 2015-2019 MUSTANG	M-1104-AB	17
FRONT/REAR SPRING KITS, 1979-2004 MUSTANG	M-5300-G	44
FRONT/REAR SPRING KITS, 1979-2004 MUSTANG	M-5300-B	44
FRONT/REAR SPRING KITS, 1979-2004 MUSTANG	M-5300-C	44
FUEL INJECTOR SET, 52 LB/HR	M-9593-MU52	166
FUEL INJECTOR SET, 60 LB/HR	M-9593-LU60	166
FUEL INJECTOR SET, 80 LB/HR	M-9593-LU80	166
FUEL INJECTOR SET, FORD PERFORMANCE 24 LB/HR	M-9593-LU24A	166
FUEL INJECTOR SET, FORD PERFORMANCE 39 LB/HR	M-9593-M39	166
FUEL INJECTOR SET, FORD PERFORMANCE 47 LB/HR	M-9593-G302	166
FUEL INJECTOR SET, FORD PERFORMANCE 47 LB/HR	M-9593-LU47	166
FUEL PUMP ECCENTRIC	M-6287-B302	138

PART DESCRIPTION	PART NUMBER	PAGE
FUEL PUMP ECCENTRIC	M-6287-C302	138
FUEL PUMP KIT, 2005-2009 MUSTANG GT DUAL	M-9407-GT05	165
GEN 1 5.0L COYOTE LONG BLOCK	M-6006-M50A1	87
GEN 1 COYOTE 5.2L HIGH PERFORMANCE CAMS	M-6550-M52A	97
GEN 2 5.0L COYOTE ALUMINATOR NA CRATE ENGINE	M-6007-A50NAA	83
GEN 2 5.0L COYOTE ALUMINATOR SC CRATE ENGINE	M-6007-A50SCA	82
GEN 2 COYOTE 5.2L HIGH PERFORMANCE CAMS	M-6550-M52	97
GEN 3 5.0 COYOTE ALUMINATOR CRATE ENGINE (12.0:1 COMPRESSION RATIO)	M-6007-A50NAB	81
GEN 3 5.0 COYOTE ALUMINATOR CRATE ENGINE (9.5:1 COMPRESSION RATIO)	M-6007-A50SCB	81
GEN 3 5.0L COYOTE 460HP MUSTANG AUTOMATIC TRANSMISSION CRATE ENGINE	M-6007-M50CAUTO	80
GEN 3 5.0L COYOTE 460HP MUSTANG CRATE ENGINE	M-6007-M50C	80
GEN 3 5.0L COYOTE LONG BLOCK	M-6006-M50C	86
GEN 3 5.0L COYOTE POWER MODULE WITH 10-SPEED AUTOMATIC TRANSMISSION	M-9000-PMCA3	79
GEN 3 5.0L COYOTE POWER MODULE WITH 6 SPEED MANUAL TRANSMISSION	M-9000-PMCM3	79
GEN 3 COYOTE 5.0L CYLINDER HEAD LH	M-6050-M50B	97
GEN 3 COYOTE 5.0L CYLINDER HEAD RH	M-6049-M50B	97
GEN 3 ENGINE MANUAL TRANSMISSION UPFIT KIT	M-12000-M50B	93
GRAPHITE INTAKE GASKET FOR STD PORT 302/351W	M-9439-G50	141
GRILLE EMBLEM, COBRA JET	M-16098-CJG	192
GRILLE, MODIFIED 2013 BOSS 302S	M-8200-MBRA	51
GT350 5.2L COYOTE INTAKE MANIFOLD	M-9424-M52	100
GT350 CYLINDER HEAD LH SEMI FINISHED	M-6050-M52X	98
GT350 CYLINDER HEAD RH SEMI FINISHED	M-6049-M52X	98
GT350 DIFFERENTIAL COOLER KIT	M-4000-M8S	18
GT4 CV BOOT LH	M-3A331-GT4A	184
GT4 CV BOOT RH	M-3A331-GT4B	184
HALF SHAFT ASSEMBLY (LEFT SIDE), 2015-2018 MUSTANG	M-4139-MA	20
HALF SHAFT ASSEMBLY (RIGHT SIDE), 2015-2018 MUSTANG	M-4138-MA	20
HALF SHAFT KIT, 2015-2018 MUSTANG GT350	M-4130-M8S	20
HALF SHAFT UPGRADE KIT, 2015-2018 MUSTANG	M-4130-MA	20
HANDLING PACK ADJUSTABLE, 2005-2014 MUSTANG GT COUPE ASSEMBLED	M-FR3A-MGTAA	42
HANDLING PACK FASTENER KIT, 2005-2014 MUSTANG	M-FR3-FASTENERS	43
HANDLING PACK FASTENER KIT, 2015-2019 MUSTANG	M-FR3-FASTENA	22
HANDLING PACK, 2005-2014 MUSTANG GT COUPE ASSEMBLED	M-FR3A-MGTA	42
HANDLING PACK, 2007-2014 MUSTANG GT500 COUPE ASSEMBLED	M-FR3A-MSVTA	43
HANDLING PACK, 2007-2014 MUSTANG SVT COUPE	M-FR3-MSVTA	43
HANDLING PACK, 2011-2018 FIESTA	M-FR3-FA	61
HANDLING PACK, FORD PERFORMANCE MUSTANG MAGNARIDE®	M-9602-M	24
HARDENED STEEL LIFTER CUP-SET OF 16, HIGH PERFORMANCE	M-6500-R302HLC	138
HEAD BOLT KIT	M-6065-D289	130
HIGH LIFT HOT ROD CAM SET, 2005-2010 MUSTANG GT	M-6550-3V	110
HIGH PERFORMANCE BRAKE COOLING SHIELDS, 2005-2014 MUSTANG	M-20045-MSVT	50
HIGH PERFORMANCE CAMS, 2015-2018 2.3L ECOBOOST	M-6250-23EBH	114
HIGH PERFORMANCE CLUTCH FLUID LINE UPGRADE, 2005-2014 MUSTANG	M-7512-A	177
HIGH TORQUE MINI STARTER - SMALL BLOCK	M-11000-B51	143
HIGH TORQUE MINI STARTER - SMALL BLOCK	M-11000-MT164	143
HIGH-FLOW AIR FILTER REPLACEMENT, 2005-2009 MUSTANG GT/V6 COLD AIR KIT DISPOSABLE	M-9601-B	37
HIGH-FLOW K&N / FORD PERFORMANCE AIR FILTER, 2010-2014 MUSTANG GT & 2011-2014 V6	M-9601-MGT	37
HIGH-PERFORMANCE CAM PHASER, 2015-2017 5.0L/5.2L COYOTE	M-6004-A50R	94
HIGH-TORQUE MINI STARTER - COYOTE & MODULAR ENGINES	M-11000-C50	102
HOOD LATCH & PIN KIT	M-16700-A	192
HOOD LIFT KIT W/ LASER ENGRAVED "FORD PERFORMANCE" LOGO, 2005-2014 MUSTANG	M-16826-M	51
HOOD LIFT KIT W/ LASER ENGRAVED "FORD PERFORMANCE" LOGO, 2015-2019 MUSTANG	M-16826-MA	26
HOOD PIN KIT, COBRA JET AND FR500S	M-16700-S	192
HUB KIT WITH ARP STUDS, 2005-2014 MUSTANG V6 / BOSS / GT / SHELBY GT500	M-1104-A	47
HURST® T-5/T-45 SHIFTER, 1979-2004 MUSTANG	M-7210-M	172
HYDRAULIC ROLLER CAM LIFTERS	M-6500-R302	138
HYDRAULIC ROLLER CAM LIFTERS, HIGH PERFORMANCE	M-6500-R302H	138
HYDRAULIC ROLLER TAPPET CAMSHAFTS, SMALL BLOCK V-8	M-6250-B303	137
HYDRAULIC ROLLER TAPPET CAMSHAFTS, SMALL BLOCK V-8	M-6250-E303	137
HYDRAULIC ROLLER TAPPET CAMSHAFTS, SMALL BLOCK V-8	M-6250-F303	137
HYDRAULIC ROLLER TAPPET CAMSHAFTS, SMALL BLOCK V-8	M-6250-X303	137

PART DESCRIPTION	PART NUMBER	PAGE
IDLER BRACKET, 1979-1993 MUSTANG OFF-ROAD	M-8604-A50	143
IGNITION COIL BRACKET - CHROME	M-12044-A2	192
IGNITION COIL SET (8), EARLY 5.0L COYOTE ENGINE	M-12029-M50C	102
IGNITION COIL SET, 2007-2014 MUSTANG SVT 4V	M-12029-4V	111
INJECTOR NOZZLE AND PUMP KIT, 6.7L DIESEL	M-9546-67	65
INTAKE MANIFOLD GASKET, PORTED Z CYLINDER HEAD	M-9439-ZP	141
INTAKE MANIFOLD, 289/302 DUAL PLANE	M-9424-F302	142
INTAKE MANIFOLD, 289/302 SINGLE PLANE "VICTOR JR."	M-9424-D302	141
INTAKE MANIFOLD, FORD PERFORMANCE COBRA JET 5.0L	M-9424-M50CJA	100
INTAKE PLAQUE, 1996-1998 COBRA	M-1447-D46	191
INTAKE PLAQUE, 1999-2001 COBRA	M-1447-F46	191
INTAKE SHROUD, 2005-2010 MUSTANG GT	M-6949-3V	112
INTAKE VALVE	M-6507-A304	136
INTAKE VALVE	M-6507-B429	147
INTAKE VALVE	M-6507-J302	135
INTAKE VALVE 7MM	M-6507-D3047	136
INTAKE VALVE LIGHTWEIGHT 5.2L COYOTE - QTY 8	M-6507-M52	99
INTERCOOLER PUMP KIT- COBRA JET - GT500	M-8501-M58	103
IRS AXLE GIRDLE COVER, 1999-2004 COBRA	M-4033-G3	178
IRS KNUCKLE KIT WITH TOE BEARING, 2015-2019 MUSTANG	M-5970-M	18
IRS SUPER 8.8-INCH RING AND PINION SET - 4.09 RATIO, 2015-2019 MUSTANG	M-4209-88409A	179
JOUNCE BUMPER & HARDWARE KIT, 2015-2019 MUSTANG	M-5570-B	20
JOUNCE BUMPER KIT, 2005-2014 MUSTANG	M-5570-A	44
KIT CAR IRS BEARING	M-1215-A	177
KIT CAR IRS HUB	M-1109-A	177
KNUCKLE TO TOE LINK BEARING ASSEMBLY, 2015-2019 MUSTANG	M-5A460-M	18
LASH ADJUSTERS, FORD GT AND 5.4L GT500	M-6500-GT	109
LATE 5.0L COYOTE ENGINE IGNITION COIL SET (8)	M-12029-M50E	103
LICENSE PLATE - SINGLE, "FORD PERFORMANCE"	M-1828-FPONE	193
LICENSE PLATE FRAME - BLACK POWDERCOAT	M-1828-SSB	194
LICENSE PLATE FRAME - BRUSHED STAINLESS-STEEL	M-1828-SSC	194
LICENSE PLATE FRAME, STAINLESS STEEL "FORD PERFORMANCE"	M-1828-SS304C	194
LIGHT BAR KIT, 2019 RANGER 40" RIGID LED	M-15200K-R	76
LOCKING HEADER BOLT SYSTEM, "STAGE 8" - 3/8"-16 x 0.75"	M-9432-A50	42
LOCKING HEADER BOLT SYSTEM, "STAGE 8" - 3/8"-16 x 1.0"	M-9432-A51	42
LOWER CONTROL ARM RELOCATION BRACKET, 2005-2014 MUSTANG	M-5650-A	48
LOWERING SPRINGS, 2005-2014 MUSTANG GT COUPE STREET	M-5300-KA	44
LOWERING SPRINGS, 2005-2014 MUSTANG GT TRACK	M-5300-PA	45
LOWERING SPRINGS, 2012-2013 BOSS 302	M-5300-T	45
LOWERING SPRINGS, 2012-2013 FOCUS	M-5300-S	61
LOWERING SPRINGS, 2015-2018 MUSTANG GT350	M-5300-W	20
LUG NUT KIT, 2015-2019 F-150	M-1012-FA	73
LUG NUT KIT, 2015-2019 MUSTANG	M-1012-M	27
LUG NUT KIT, 2015-2019 MUSTANG OPEN BACK	M-1012-N	28
LUG NUT KIT, F-150 BLACK	M-1012K-F15B	74
LUG NUT KIT, FORD PERFORMANCE	M-1012-A	54
LUG NUT KIT, MK2 FOCUS RS WHEEL	M-1012-RSA	63
LUG NUT VEHICLE KIT, 2015-2019 MUSTANG/FORD GT BLACK	M-1012K-MB	28
LUG NUTS, 2015-2019 MUSTANG BLACK	M-1012-MB	27
MAF HOUSING, COBRA JET 123 MM BILLET	M-9600-CJ	165
MAF TUNER KIT, SUPER COBRA JET 140MM	M-9600-SCJ	165
MANUAL TRANSMISSION FLYWHEEL	M-6375-B302	174
MANUAL TRANSMISSION FLYWHEEL ALUM 157T 28.2	M-6375-A302AB	174
MANUAL TRANSMISSION FLYWHEEL ALUMINUM 157T 0	M-6375-D302AB	174
MANUAL TRANSMISSION FLYWHEEL BILLET STEEL 164T 0 OZ.-IN.	M-6375-M302	174
MANUAL TRANSMISSION FLYWHEEL BILLET STEEL 164T 28.2	M-6375-K302	174
MANUAL TRANSMISSION FLYWHEEL BILLET STEEL 184T 0 OZ.-IN.	M-6375-N427	174
MANUAL TRANSMISSION FLYWHEEL STEEL 157 28.2	M-6375-A302B	174
MANUAL TRANSMISSION FLYWHEEL STEEL 157T 0	M-6375-D302B	174
MANUAL TRANSMISSION FLYWHEEL STEEL 157T 50	M-6375-C302B	174
MASS AIR METER, 2001-2004 F-150 LIGHTNING	M-12579-L54	165
MODULAR 3V ROCKER ARM AND LASH ADJUSTER KIT	M-6529-3V	109
MODULAR AND COYOTE ENGINE SHIPPING AND STORAGE CRADLE	M-6038-M	91
MODULAR BELLHOUSING INSTALLATION KIT	M-7771-A	173
MUFFLER KIT - BLACK CHROME TIPS, 2015-2017 MUSTANG GT 5.0L TOURING	M-5230-M8SC	13
MUFFLER KIT - BLACK CHROME TIPS, 2015-2019 MUSTANG 2.3L ECOBOOST EXTREME	M-5230-M4EBA	14
MUFFLER KIT - BLACK CHROME TIPS, 2015-2019 MUSTANG 2.3L ECOBOOST SPORT	M-5230-M4SBA	14

PARTS INDEX (CONTINUED)

PART DESCRIPTION	PART NUMBER	PAGE
MUFFLER KIT - BLACK CHROME TIPS, 2015-2019 MUSTANG 2.3L ECOBOOST TOURING	M-5230-M4TBA	14
MUFFLER KIT - BLACK CHROME TIPS, 2018-2019 MUSTANG GT 5.0L EXTREME	M-5230-M8EBA	14
MUFFLER KIT - BLACK CHROME TIPS, 2018-2019 MUSTANG GT 5.0L SPORT	M-5230-M8SBA	14
MUFFLER KIT - BLACK CHROME TIPS, 2018-2019 MUSTANG GT 5.0L TOURING	M-5230-M8TBA	14
MUFFLER KIT - CARBON FIBER TIPS, 2015-2019 MUSTANG 2.3L ECOBOOST EXTREME	M-5230-M4EFA	14
MUFFLER KIT - CARBON FIBER TIPS, 2015-2019 MUSTANG 2.3L ECOBOOST MUSTANG TOURING	M-5230-M4TFA	14
MUFFLER KIT - CARBON FIBER TIPS, 2015-2019 MUSTANG 2.3L ECOBOOST SPORT	M-5230-M4SFA	14
MUFFLER KIT - CARBON FIBER TIPS, 2018-2019 MUSTANG GT 5.0L EXTREME	M-5230-M8EFA	14
MUFFLER KIT - CARBON FIBER TIPS, 2018-2019 MUSTANG GT 5.0L SPORT	M-5230-M8SFA	14
MUFFLER KIT - CARBON FIBER TIPS, 2018-2019 MUSTANG GT 5.0L TOURING	M-5230-M8TFA	14
MUFFLER KIT - CHROME TIPS, 2015-2017 MUSTANG GT 5.0L TOURING	M-5230-M8TC	13
MUFFLER KIT - CHROME TIPS, 2015-2019 MUSTANG 2.3L ECOBOOST EXTREME	M-5230-M4ECA	14
MUFFLER KIT - CHROME TIPS, 2015-2019 MUSTANG 2.3L ECOBOOST SPORT	M-5230-M4SCA	14
MUFFLER KIT - CHROME TIPS, 2015-2019 MUSTANG 2.3L ECOBOOST TOURING	M-5230-M4TCA	14
MUFFLER KIT - CHROME TIPS, 2018-2019 MUSTANG GT 5.0L EXTREME	M-5230-M8ECA	14
MUFFLER KIT - CHROME TIPS, 2018-2019 MUSTANG GT 5.0L SPORT	M-5230-M8SCA	14
MUFFLER KIT - CHROME TIPS, 2018-2019 MUSTANG GT 5.0L TOURING	M-5230-M8TCA	14
MUFFLER KIT (49 STATE), 2011-2012 MUSTANG SHELBY GT500 SPORT	M-5230-MSVTLA	39
MUFFLER KIT (49 STATE), 2011-2014 MUSTANG GT	M-5230-MGTCAl	40
MUFFLER KIT (49 STATE), 2011-2014 MUSTANG GT/BOSS SPORT	M-5230-MGTLA	40
MUFFLER KIT (49 STATE), 2013-2014 MUSTANG SHELBY GT500 SPORT	M-5230-MSVTLB	39
MUFFLER KIT WITH GT350 EXHAUST TIPS & LOWER VALANCE, 2015-2017 Mustang GT 5.0L SPORT	M-5230-M8SBV	12
MUFFLER KIT WITH GT350 EXHAUST TIPS & LOWER VALANCE, 2015-2017 Mustang GT 5.0L TOURING	M-5230-M8TBV	13
MUFFLER KIT WITH GT350 EXHAUST TIPS & LOWER VALANCE, 2015-2017 MUSTANG 2.3L ECOBOOST TOURING	M-5230-M4TBV	16
MUFFLER KIT, 2005-2009 MUSTANG GT / 2007-2009 MUSTANG SHELBY GT500 "S"	M-5230-S	40
MUFFLER KIT, 2005-2009 MUSTANG GT SPECIAL EDITION MUSTANG	M-5230-GTB	40
MUFFLERS (49 STATE LEGAL), 2011-2014 MUSTANG V6 SPORT	M-5230-MV6LA	41
MUFFLERS (50 STATE), 2011-2014 MUSTANG V6 TOURING	M-5230-MV6CA	41
MUFFLERS WITH REAR LOWER VALENCE, 2013-2014 MUSTANG GT AXLE BACK QUAD TIP	M-5230-MSVTCd	41
MUSTANG BRUSHED PEDAL KIT FOR AUTOMATIC	M-2301-BA	26
MUSTANG BRUSHED PEDAL KIT FOR MANUAL TRANSMISSION	M-2301-BM	26
MUSTANG FR500C, BOSS 302R/S BRAKE BOOSTER	M-2005-R	50
MUSTANG FR500S DIFFERENTIAL	M-4204-T3IH	181
MUSTANG GT350 TRANSMISSION WITH PUMP	M-7000-M8S	19
MUSTANG IRS SUPER 8.8-INCH RING AND PINION SET - 3.55 RATIO	M-4209-88355A	179
MUSTANG IRS SUPER 8.8-INCH RING AND PINION SET - 3.73 RATIO	M-4209-88373A	179
MUSTANG IRS SUPER 8.8-INCH RING AND PINION SET - 3.73 RATIO	M-4209-88373B	179
MUSTANG REAR UPPER SHOCK MOUNT	M-18197-A	44
MUSTANG ROAD RACE REAR LOWER CONTROL ARM BUSHINGS	M-5638-A	47
MUSTANG SHELBY GT500 5.4L PRODUCTION ALUMINUM CYLINDER BLOCK	M-6010-M54A	91
MUSTANG SHELBY GT500 INTERCOOLER PUMP	M-8501-MSVT	103
MUSTANG SUPER 8.8 IRS BEARING & SEAL KIT	M-4413-B	19
MUSTANG SVT 5.4L MODULAR ROCKER ARM SET	M-6529-MSVT	109
MUSTANG TRACKKEY, 2012-2013 BOSS 302	M-9603-MBTKA	39
OFF-ROAD BUMPER - FRONT, 2019 RANGER	M-17757-RIF	75
OFF-ROAD FOG LIGHT KIT, 2019 RANGER	M-15200-RFOG	75
OFF-ROAD LIGHT KIT, RANGER HOOD HINGE-MOUNTED	M-15200-RHM	75
OFF-ROAD RECOVERY KIT, FORD PERFORMANCE BY WARN® INDUSTRIES	M-1830-FPORR	71
OFF-ROAD RECOVERY KIT-HEAVY DUTY, FORD PERFORMANCE BY WARN® INDUSTRIES	M-1820-FPORRHd	71
OFF-ROAD SUSPENSION DAMPER KIT, RANGER	M-18000-R	75
OFF-ROAD UNDER BODY/ROCK LIGHT KIT	M-15200-RUN	76
OFF-ROAD/TRACK AIR COMPRESSOR KIT, FORD PERFORMANCE	M-1830-FPAC	195

PART DESCRIPTION	PART NUMBER	PAGE
OIL FILL CAP COVER FOR 4.6L/5.4L/6.8L, CHROMED ALUMINUM	M-6766-MP46A	191
OIL FILTER ADAPTER KIT, COYOTE GEN 2	M-6880-M501	95
OIL FILTER ADAPTER, PUSHROD V8 90 DEGREE	M-6880-A50	133
OIL FILTER, FORD RACING HIGH PERFORMANCE	CM-6731-FL1A	133
OIL FILTER, FORD RACING HIGH PERFORMANCE	CM-6731-FL820	133
OIL FILTERS, CASE	M-6731-FL1A	133
OIL FILTERS, CASE	M-6731-FL820	133
OIL LINE ADAPTOR, 2011-2014 5.0L 4V TI-VCT	M-6881-M50	93
OIL LINE ADAPTOR, 2015-2017 5.0L COYOTE	M-6881-M50A	95
OIL PAN GASKET, 289/302 ONE-PIECE RUBBER	M-6710-A50	141
OIL PAN KIT, 2017 GEN 2 5.0L COYOTE	M-6675-M50A1	93
OIL PAN REINFORCEMENT RAILS, 289-302 SB	M-6674-302	133
OIL PAN, 2011-2017 5.0L COYOTE 4V TI-VCT RACE	M-6675-M50BR	95
OIL PAN, COYOTE 5.0L/5.2L ROAD RACE	M-6675-M52RR	94
OIL PUMP DRIVE SHAFT, 289/302	M-6605-B302	131
OIL PUMP, 289/302 HIGH VOLUME	M-6600-D2	131
OIL SUMP PICKUP TUBE	M-6622-M50RR	95
OIL SUMP PICKUP TUBE	M-6622-M52RR	95
OIL-AIR SEPARATOR RH, 2018-2019 5.0L COYOTE	M-6766-A50A	10
OVAL AIR CLEANER ASSEMBLY (COBRA LOGO)	M-9600-C302	191
OVAL AIR CLEANER ASSEMBLY (MUSTANG LOGO)	M-9600-K302	191
PAC 1219X BEEHIVE VALVE SPRING	M-6513-1219X	136
PANHARD BAR BUSHING KIT, 2005-2014 MUSTANG ADJUSTABLE	M-4266-A	48
PANHARD BAR, 2005-2014 MUSTANG ADJUSTABLE	M-4264-A	47
PARKING BRAKE CABLE, ADJUSTABLE	M-2810-A	50
PENNANT STRING, "FORD PERFORMANCE" 50 -FT.	M-1827-P2	194
PENNANT STRING, "FORD RACING" 50-FT.	M-1827-P1	194
PERFORMANCE 5.0L COYOTE COLD SPARK PLUG SET	M-12405-M50A	101
PERFORMANCE CALIBRATION POWER PACK 1, 2015-2017 MUSTANG GT	M-9603-M8	8
PERFORMANCE CALIBRATION, 2018-2019 MUSTANG ECOBOOST	M-9603-M4C	9
PERFORMANCE COOLING FAN, 2005-2014 MUSTANG	M-8C607-MSVT	104
PERFORMANCE FRONT RS BRAKE UPGRADE KIT, 2013-2018 FOCUS ST	M-2300-W	61
PERFORMANCE INTAKE AND CALIBRATION POWER PACK 3, 2015-2017 MUSTANG GT	M-9452-M8	8
PERFORMANCE PACK BOOST GAUGE KIT, 2015-2018 MUSTANG FOCUS ST	M-10849-A	187
PERFORMANCE REAR RS BRAKE UPGRADE KIT, 2013-2018 FOCUS ST	M-2300-WR	61
PERFORMANCE RS COLD AIR INTAKE BOX, 2013-2018 FOCUS ST	M-9603-FSTA	58
PERFORMANCE RS STEERING WHEEL KIT, 2015-2018 FOCUS ST	M-3600-FRS	62
PINION FLANGE 8.8-INCH AXLE	M-4851-C	179
PINION FLANGE, 2003-2004 COBRA	M-4851-B	179
PINION SEAL 9" AXLE, "BENDA"	M-4676-A111	182
PLUG AND DOWEL KIT	M-6026-A	129
PLUG AND DOWEL KIT	M-6026-A460	146
PLUG AND DOWEL KIT	M-6026-C146	106
POWER UPGRADE PACK, 2013-2018 Focus ST FR1	M-FR1-FSTA	57
POWER UPGRADE PACKAGE, 2005-2009 MUSTANG V6	M-2007-FR1V6	35
POWER UPGRADE PACKAGE, 2011-2014 MUSTANG GT	M-FR1-MGTB	35
PRESSURE PLATE BOLT AND DOWEL KIT, 10.5"	M-6397-A302	173
PRESSURE PLATE BOLT AND DOWEL KIT, 11"	M-6397-B46	173
PRIMARY TIMING CHAIN SET, COYOTE/GT350	M-6004-GT350PC	94
PULLEY SET, 1965-1969 MUSTANG BILLET SINGLE GROOVE	M-8509-CM	143
PULLEY SET, 1970-1978 MUSTANG BILLET DUAL GROOVE	M-8509-EM	143
PULLEY SET, 1970-1978 MUSTANG BILLET SINGLE GROOVE	M-8509-DM	143
QUAIFE TORQUE BIASING DIFFERENTIAL INSTALLATION KIT, 2013-2017 FOCUS ST	M-4026-FST	60
QUAIFE TORQUE BIASING DIFFERENTIAL INSTALLATION KIT, 2014-2017 FIESTA ST	M-4026-FA	60
RACE SIDE STEPS - SUPER CAB, 2015-2019 F-150/RAPTOR	M-16450-F15RAD	71
RACE SIDE STEPS - SUPER CREW, 2015-2019 F-150/RAPTOR	M-16450-F15RAC	71
RADIATOR CAP WITH FORD RACING LOGO	M-8100-A	39
RADIATOR, 2011-2014 MUSTANG GT BOSS 302	M-8005-MBR	38
RADIATOR, 2015-2019 MUSTANG GT 5.0L PERFORMANCE GT350	M-8005-M8	10
REAR BRAKE BRACKET UPGRADE KIT, 1994-2004 MUSTANG GT	M-2300-M	49
REAR BRAKE KIT, 2015-2017 MUSTANG	M-2300-MR	24
REAR DISC BRAKE KIT LATE MODEL FORD 9-INCH TRUCK AXLE HOUSING, 5-LUG	M-2300-G2	182
REAR LOWER CONTROL ARM UPGRADE KIT, 2005-2014 MUSTANG	M-5538-A	48
REAR LOWERING KIT, 2004-2014 F-150	M-3000-G	69
REAR LOWERING KIT, 2015-2019 F-150	M-3000-HA	69
REAR SPOILER KIT, 2016-2018 FOCUS	M-5844210-RS	62
REAR SPOILER, 2005-2009 MUSTANG SVT	M-16600-SVTC	50

PART DESCRIPTION	PART NUMBER	PAGE
REAR TOE LINK KIT, 2015-2019 MUSTANG PERFORMANCE PACK	M-5972-M	18
REAR WHEEL HUB KIT WITH ARP STUDS, 2015-2019 MUSTANG	M-1104-B	17
RECARO SEAT SET, 2018-2019 MUSTANG "FORD PERFORMANCE" LOGO	M-63660005-MF	26
RED STARTER BUTTON INSTALLATION KIT, 2015-2017 MUSTANG	M-10B776-MR	26
REPLACEMENT 3V HEADER GASKETS	M-9448-A463V	110
RIGHT HAND DRIVE STRUT TOWER BRACE KIT, 2015-2017 MUSTANG GT350R	M-20201-M350RHD	23
RIGHT HAND DRIVE SUPERCHARGER CLOSE OUT PANEL KIT, 2015-2017 MUSTANG GT	M-9066-M8RHD	8
ROCK SLIDER SIDE STEPS, RAPTOR/F-150 SUPERCAB	M-16450-F15RAB	71
ROCK SLIDER SIDE STEPS, RAPTOR/F-150 SUPERCREW	M-16450-F15RA	71
ROCKER ARM PEDESTAL SHIM KIT	M-6529-B302	139
ROCKER CHANNEL KIT	M-6588-A50	139
ROLLER CAM CONVERSION KIT	M-6253-A50	137
ROLLER PILOT BEARING - HIGH LOAD - 4.6L/5.4L/5.0L4	M-7600-C	176
ROLLER PILOT BEARING 4.6L/5.4L AND 5.0L 4V TIVCT MODULAR ENGINES	M-7600-B	176
ROLLER PILOT BEARING FOR 289 / 302 / 351C AND 351W S347/D347SR/D347SR7 CONNECTING ROD SET W/7/16" ROD BOLTS	M-6200-716	129
SCJ VALVE PUSH ROD PLATE - FITS ONE CYLINDER HEAD	M-6566-SCJA	136
SHIFT KNOB - CARBON FIBER, BLACK, 6 SPEED, FOCUS ST	M-7213-FSTCF	59
SHIFT KNOB 6-SPEED - BLACK, FORD PERFORMANCE GT350	M-7213-M8SB	17
SHIFT KNOB 6-SPEED - RED, FORD PERFORMANCE GT350	M-7213-M8SR	17
SHIFT KNOB 6-SPEED - WHITE, FORD PERFORMANCE GT350	M-7213-M8SW	17
SHIFT KNOB 6-SPEED, FORD PERFORMANCE	M-7213-M8A	17
SHIFT KNOB 6-SPEED, FORD RACING	M-7213-M8	17
SHIFT KNOB, 2015-2019 MUSTANG CARBON FIBER	M-7213-MCF	17
SHIFT KNOB, 2016-2019 F-SERIES CARBON FIBER	M-7213-F15CF	69
SHIFT KNOB, MUSTANG BULLITT™ WHITE	M-7213-M8B	17
SHIFTER KIT - WITHOUT KNOB, 2015-2019 MUSTANG	M-7210-MA	16
SHIFTER KIT - WITHOUT KNOB, 2015-2019 MUSTANG GT350	M-7210-M8A	16
SHIFTER KIT, 2015-2019 MUSTANG SHORT THROW	M-7210-M8C	16
SHIFTER, 2011-2014 MUSTANG V6/GT 6 SPEED	M-7210-MGTB	172
SHIFTER, 2016-2018 FOCUS RS SHORT THROW	M-7210-FRS	59
SHOCK/STRUT KIT, 2006-2007 FOCUS PERFORMANCE	M-18000-ZX3B	60
SHORT THROW SHIFTER, 2005-2009 MUSTANG GT	M-7210-MGT	172
SHORT THROW SHIFTER, 2012-2014 FOCUS 5-SPEED	M-7210-FS	59
SHORT THROW SHIFTER, 2013-2018 FOCUS ST	M-7210-FST	59
SILL PLATE SET, 2015-2019 F-150 "FORD PERFORMANCE"	M-1613208-F15A	71
SILL PLATE SET, 2015-2019 MUSTANG "FORD PERFORMANCE"	M-1613208-A	26
SINGLE FRONT SERVICE REPLACEMENT STRUT FOR - M-18000-A	M-18001-AF	43
SINGLE REAR SERVICE REPLACEMENT STRUT FOR - M-18000-A	M-18001-ARI	43
SKID PLATE KIT, 2017-2019 F-150 RAPTOR	M-5018-F15RB	73
SPARK PLUG (16 MM THREAD), 3V COLD	M-12405-3V0A	112
SPARK PLUG SET (12 MM THREAD), 3V COLD	M-12405-3V12MM	111
SPECIAL U-JOINT KIT	M-4635-A	183
SPLITTER HARDWARE KIT, 2010-2012	M-16601H-MB	50
SPORT EXHAUST MID-PIPE, 2011-2014 F-150 SVT RAPTOR 6.2L 133-INCH WB CAT-BACK	M-5248-F15R133L	68
SPORT EXHAUST SYSTEM MID-PIPE, 2011-2014 F-150 3.5L ECOBOOST & 5.0L COYOTE 126-INCH WHEELBASE	M-5248-F15126L	68
SPORT EXHAUST SYSTEM MID-PIPE, 2011-2014 F-150 3.5L ECOBOOST & 5.0L COYOTE 133-INCH WHEELBASE	M-5248-F15133L	68
SPORT EXHAUST SYSTEM MID-PIPE, 2011-2014 F-150 3.5L ECOBOOST & 5.0L COYOTE 157-INCH WHEELBASE	M-5248-F15157L	68
SPORT EXHAUST SYSTEM MID-PIPE, 2011-2014 F-150 3.5L ECOBOOST & 5.0L COYOTE 163-INCH WHEELBASE	M-5248-F15163L	68
SPRING KIT, 2013 COBRA JET	M-5300-RA	44
SPRINGS, 2007-2014 MUSTANG SHELBY GT500	M-5300-L	45
STARTER INDEX PLATE MODULAR BLOCK AUTOMATIC TRANSMISSION	M-6373-A	173
STARTER INDEX PLATE MODULAR BLOCK MANUAL TRANSMISSION	M-7007-A	174
STARTER INDEX PLATE SMALL BLOCK MANUAL TRANSMISSION	M-7007-B	174
STEERING WHEEL - OFF-ROAD, FORD PERFORMANCE	M-3600-RA	52
STEERING WHEEL HUB ADAPTER	M-3602-R	52
STEERING WHEEL KIT- ORANGE SIGHTLINE, 2015-2018 F-150 RAPTOR PERFORMANCE	M-3600-F15ROR	70
STEERING WHEEL KIT- RED SIGHTLINE, 2015-2018 F-150 RAPTOR PERFORMANCE	M-3600-F15RRD	70
STREET HANDLING PACK, 2015-2019 MUSTANG	M-FR3A-MAA	22
STREET LOWERING SPRINGS, 2015-2019 MUSTANG	M-5300-X	20
STREET SWAY BAR AND SPRING KIT, 2015-2019 MUSTANG	M-5700-MA	21
STRUT TOWER BRACE KIT, 2015-2019 MUSTANG GT350R	M-20201-GT350	23

PART DESCRIPTION	PART NUMBER	PAGE
STRUT TOWER BRACE, 2005-2014 MUSTANG GT	M-20201-S197	46
STRUT TOWER BRACE, 2005-2014 MUSTANG V6	M-20201-F	46
STRUT TOWER BRACE, 2015-2017 MUSTANG RIGHT HAND DRIVE	M-20201-MARHD	23
STRUT TOWER BRACE, 2015-2019 MUSTANG FORD PERFORMANCE	M-20201-MA	23
STRUT/SHOCK KIT, 2000-2005 SVT FOCUS	M-18000-ZX3	60
STRUT/SHOCK KIT, 2005-2014 MUSTANG COUPE DYNAMIC	M-18000-A	43
STRUT/SHOCK KIT, 2005-2014 MUSTANG GT / 2007-2014 SVT ADJUSTABLE	M-18000-C	43
SUPER 8.8 RING GEAR BOLT KIT (10 PIECES)	M-4216-C	19
SUPER 8.8 TORSEN DIFFERENTIAL, 2015-2019 MUSTANG GT	M-4204-MT	19
SUPER 8.8" IRS LOADED DIFFERENTIAL HOUSING - 3.55, 2015-2019 MUSTANG	M-4001-883558	19
SUPER 8.8" IRS RING AND PINION INSTALLATION KIT, 2015-2019 MUSTANG	M-4210-B3	18
SUPER 8.8-INCH TRACTION-LOK DIFFERENTIAL, 2015-2019 MUSTANG	M-4204-M	19
SUPER COBRA JET CYLINDER HEAD - ASSEMBLED WITH DUAL SPRINGS	M-6049-SCJA	146
SUPER COBRA JET CYLINDER HEAD - BARE	M-6049-SCJ	146
SUPER COBRA JET CYLINDER HEAD ASSEMBLED WITH DUAL SPRINGS W/DAMPER	M-6049-SCJB	146
SUPER COBRA JET MECHANICAL THROTTLE BODY	M-9926-SCJM	165
SUPERCHARGER COIL COVERS, 2018-2019 MUSTANG	M-9608-M50SC	27
SUPERCHARGER KIT 670 HP, 2015-2017 MUSTANG GT	M-6066-M8627	7
SUPERCHARGER KIT 700 HP, 2018-2019 MUSTANG GT	M-6066-M8	7
SUPERCHARGER, 2018-2019 F-150 5.0L	M-6066-F150SCK	77
SUSPENSION KIT, 2000-2005 FOCUS	M-3000-ZX3	60
SUSPENSION KIT, 2000-2005 FOCUS ASSEMBLED	M-3000-ZX3A	60
SUSPENSION KIT, 2015-2018 F-150 FOX "TUNED BY FORD PERFORMANCE" 2.0 IFP OFF-ROAD	M-18000-F15A	69
SVT BRAKE UPGRADE KIT w/ 2-PIECE ROTORS, 2005-2014 MUSTANG GT 14"	M-2300-SA	49
SVT BRAKE UPGRADE KIT, 2005-2014 MUSTANG GT 14"	M-2300-S	49
SVT DECKLID EMBLEM/BADGE	M-1447-SVT	192
SWAY BAR AND SPRING KIT, 2015-2018 MUSTANG GT350	M-5700-N	21
SWAY BAR KIT, 2005-2014 MUSTANG GT CONVERTIBLE	M-5490-D	45
SWAY BAR KIT, 2005-2014 MUSTANG GT COUPE	M-5490-A	45
SWAY BAR KIT, 2007-2012 MUSTANG SVT	M-5490-B	45
T-5 BEARING RETAINER (FITS 1983-1993 V8 APPLICATIONS)	M-7050-A	172
T-5 BEARING RETAINER (FITS 1994-1995 V8 APPLICATIONS)	M-7050-B	172
T-5 REBUILD KIT	M-7000-A	171
THERMOSTAT HOUSING, 90 DEGREE	M-8592-M90	143
THROTTLE BODY 87MM, 2015-2017 MUSTANG GT350	M-9926-M52	163
THROTTLE BODY ADAPTER, 87MM	M-9474-M5087	165
THROTTLE BODY INTAKE SPACER, BOSS 302 90MM	M-9474-M50B	164
THROTTLE BODY, 2005-2010 MUSTANG GT	M-9926-MGT	164
THROTTLE BODY, 2005-2010 MUSTANG GT BILLET	M-9926-3V	164
THROTTLE BODY, 2007-2014 MUSTANG SHELBY GT500	M-9926-MSVT	164
THROTTLE BODY, 2007-2014 SHELBY GT500 DUAL 65 MM	M-9926-CJ65	164
THROTTLE BODY, 2011-2014 MUSTANG 5.0L 90 MM	M-9926-M5090	164
THROTTLE BODY, 87MM MUSTANG BULLITT™	M-9926-M50B	163
THROWOUT BEARING, 1979-2004 MUSTANG V8 HD	M-7548-A	176
TIE DOWN KIT, 2015-2019 MUSTANG	M-1700-M	27
TIMING CHAIN COVER, 289/302/351W FRONT	M-6059-D351	142
TIRE SHADE, "FORD PERFORMANCE"	M-1822-A9	193
TORSEN DIFFERENTIAL, 2012-2013 MUSTANG BOSS 302	M-4204-MB	181
TOURING EXHAUST MID-PIPE, 2011-2014 F-150 SVT RAPTOR 6.2L 133-INCH WB CAT-BACK	M-5248-F15R133C	68
TOURING EXHAUST SYSTEM MID-PIPE, 2011-2014 F-150 5.0L COYOTE 133 INCH WHEELBASE	M-5248-F15133C	68
TOURING EXHAUST SYSTEM MID-PIPE, 2011-2014 F-150 5.0L COYOTE 157 INCH WHEELBASE	M-5248-F15157C	68
TOURING EXHAUST SYSTEM MID-PIPE, 2011-2014 F-150 5.0L COYOTE 163 INCH WHEELBASE	M-5248-F15163C	68
TOW HOOK ASSEMBLY, 2015-2019 GT350 FRONT	M-17954-FA	28
TOW HOOK ASSEMBLY, 2015-2019 MUSTANG REAR	M-17954-RB	28
TOW HOOK LOOP KIT	M-17954-A	51
TOW HOOKS-PAIR-BLUE, 2019 RANGER	M-18954-RAB	76
TOW HOOKS-PAIR-RED, 2019 RANGER	M-18954-RA	76
TOW RING KIT, MUSTANG FRONT	M-17954-F	51
TOW RING KIT, MUSTANG REAR	M-17954-RA	51
TPMS SENSOR AND ACTIVATION TOOL KIT FOR MUSTANG AND FOCUS	M-1180-A	54
TPMS SENSOR AND ACTIVATION TOOL KIT, 2015-2019 MUSTANG AND F-150	M-1180-B	30

PARTS INDEX (CONTINUED)

PART DESCRIPTION	PART NUMBER	PAGE
TPMS SENSOR AND ACTIVATION TOOL KIT, 2015-2019 MUSTANG BLACK	M-1180-C	30
TRACK CAL CALIBRATION, 2013-2014 MUSTANG GT	M-14204-MGTTTC	38
TRACK CAL UPDATE, 2013-2014 MUSTANG GT	M-14204-MGTTCU	38
TRACK HANDLING PACK, 2015-2019 MUSTANG	M-FR3A-M8A	22
TRACK LOWERING SPRINGS, 2015-2019 MUSTANG	M-5300-Y	20
TRACK MAT, "FORD PERFORMANCE"	M-1822-A8	193
TRACK STRUT AND SHOCK KIT, 2015-2019 MUSTANG	M-18000-F	19
TRACK SWAY BAR BUSHING KIT	M-5490-BKD	22
TRACK SWAY BAR KIT, 2015-2019 MUSTANG	M-5490-G	21
TREMAC® 6-SPEED TRANSMISSION (2.97 1ST GEAR/26 SPLINE)	M-7003-M6295	169
TREMAC® 6-SPEED TRANSMISSION (2.97 1ST GEAR/26 SPLINE)	M-7003-M6297	170
TREMEC® 5-SPEED EXTRA HD TRANSMISSION (CLOSE RATIO 26 SPLINE)	M-7003-R58H	171
TREMEC® 5-SPEED EXTRA HD TRANSMISSION (CLOSE RATIO)	M-7003-R58C	170
TREMEC® 6-SPEED TRANSMISSION (2.66 1ST GEAR/26 SPLINE)	M-7003-M6266	169
TREMEC® MAGNUM XL TRANSMISSION KIT	M-7003-M6XL	170
TREMEC® UPGRADED SUPER-DUTY T-5 TRANSMISSION	M-7003-Z	172
TUBULAR REAR LOWER CONTROL ARM KIT - SPHERICAL BEARING, 2005-2014 MUSTANG	M-5649-S	48
TUBULAR REAR LOWER CONTROL ARM KIT - URETHANE BUSHINGS, 2005-2014 MUSTANG	M-5649-R1	48
TURBO KIT, 2015-2016 6.7L DIESEL	M-TURBO-67	65
TURBO RECIRCULATION VALVE, 2016-2018 FOCUS RS PERFORMANCE	M-TRV-FPRS	58
TURBOCHARGER UPGRADE KIT, F-150 3.5L ECOBOOST	M-9438-35T	65
TWIN TURBO UPGRADE KIT, 2013-2016 F-150 3.5L	M-9438-35TA	65
UNIVERSAL PINION NUT	M-4213-A	178
UNIVERSAL VALVE COVER BREATHER CAP GROMMETS	M-6892-F	191
VALVE COVER BLACK STEALTH, FORD RACING 289-351 SLANT EDGE	302-135B	188
VALVE COVER BLACK, FORD RACING 289-351 SLANT EDGE	302-135	188
VALVE COVER BLUE, FORD RACING 289-351 SLANT EDGE	302-136	189
VALVE COVER CHROME, FORD RACING 289-351 SLANT EDGE	302-139	189
VALVE COVER GRAY, FORD RACING 289-351 SLANT EDGE	302-137	189
VALVE COVER POLISHED, FORD RACING 289-351 SLANT EDGE	302-138	189
VALVE COVER, 289-302-351W SB FORD RACING BLACK RIBBED ALUMINUM	M-6582-W351PR	191
VALVE COVER, 4 CYLINDER KENT	M-6582-16K	151
VALVE COVER, BLACK SATIN	M-6582-A	187
VALVE COVER, BLACK SATIN	M-6582-A301R	188
VALVE COVER, BLACK SATIN	M-6582-A341R	190
VALVE COVER, BLACK SATIN	M-6582-B	190
VALVE COVER, BLACK SATIN	M-6582-B301	189
VALVE COVER, BLACK SATIN	M-6582-F302	188
VALVE COVER, BLACK SATIN SMALL BLOCK 427	M-6582-W427B	189
VALVE COVER, CLEVELAND BLACK ALUMINUM	M-6582-Z351B	190
VALVE COVER, POLISHED ALUMINUM	M-6582-A302R	188
VALVE COVER, POLISHED ALUMINUM	M-6582-A342R	190
VALVE COVER, POLISHED ALUMINUM	M-6582-A427	190
VALVE COVER, POLISHED ALUMINUM	M-6582-C460	191
VALVE COVER, POLISHED ALUMINUM	M-6582-Z351	190
VALVE COVERS- MUSTANG LOGO, POLISHED ALUMINUM	M-6000-F302	189
VALVE COVERS, 289/302/351W CIRCLE TRACK	M-6582-CT2	188
VALVE COVERS, BLACK SATIN	M-6000-C302	189
VALVE COVERS, BLACK SATIN TRUCK	M-6582-A351R	190
VALVE COVERS, BLUE SATIN	M-6582-LE302BL	188
VALVE COVERS, POLISHED ALUMINUM	M-6000-D302	189
VALVE COVERS, POLISHED ALUMINUM	M-6582-C351PD	191
VALVE PUSHROD GUIDEPLATE	M-6566-Z304D	136
VALVE ROCKER ARM COVER GASKET	M-6584-A50	141
VALVE ROCKER ARM PEDESTAL SHIM KIT	M-6529-A302	139
VALVE SPRING RETAINERS	M-6514-A50	136
VALVE STEM SEALS POSITIVE-TYPE, GUIDE-MOUNTED SEAL	M-6571-A50	135
WARN UPGRADED LOCKING HUBS - BLACK	M-1104-SD	184
WATER PUMP, 2011-2018 5.0L/5.2L COYOTE 4-BOLT	M-8501-M50	104
WHEEL - GLOSS BLACK, 2012-2018 FOCUS ST 18" X 8"	M-1007-M188GB	62
WHEEL - GLOSS BLACK, 2016-2018 MK3 FOCUS RS 19" X 8"	M-1007-R198GB	62
WHEEL - MATTE BLACK, 2005-2014 MUSTANG 18" X 8" MESH SPOKE	M-1007-P188MB	53
WHEEL - MATTE BLACK, 2015-2019 F-150 20" X 8.5" SIX SPOKE	M-1007-P2085MB	73
WHEEL 19" X 10" - GLOSS BLACK WITH MACHINED FACE, MUSTANG BOSS 302S REAR	M-1007-DC1910LGB	53

PART DESCRIPTION	PART NUMBER	PAGE
WHEEL 19" X 9" - GLOSS BLACK WITH MACHINED FACE, MUSTANG BOSS 302S FRONT	M-1007-DC199LGB	53
WHEEL 19" X 9" - MATTE BLACK, 2015-2019 MUSTANG GT PERFORMANCE PACK FRONT	M-1007-M199B	29
WHEEL 19" X 9.5" - MATTE BLACK, 2015-2019 MUSTANG GT PERFORMANCE PACK REAR	M-1007-M1995B	29
WHEEL CENTER CAP - PONY EMBLEM, 2015-2019 MUSTANG	M-1096-O	28
WHEEL CENTER CAP - PONY EMBLEM, 2015-2019 MUSTANG	M-1096-O	55
WHEEL CENTER CAP SET, 2017-2019 RAPTOR / RANGER	M-1096K-RA	55
WHEEL CENTER CAP, 2005-14 FORD RACING	M-1096-FR1	55
WHEEL CENTER CAP, 2012-2018 FOCUS	M-1096-Q	55
WHEEL CENTER CAP, 2012-2018 FOCUS	M-1096-Q	62
WHEEL CENTER CAP, 2016-2018 MK3 FOCUS RS	M-1096-RS	55
WHEEL CENTER CAP, 2016-2018 MK3 FOCUS RS	M-1096-RS	63
WHEEL CENTER CAP, FORD PERFORMANCE	M-1096-FP3	28
WHEEL CENTER CAP, FORD PERFORMANCE	M-1096-FP3	55
WHEEL CENTER CAP, FORD PERFORMANCE MUSTANG TRI-BAR	M-1096-K	55
WHEEL CENTER CAP, FORD PERFORMANCE SVT	M-1096-N	55
WHEEL CENTER CAP, FORD RACING	M-1096-FR	55
WHEEL CENTER CAP, MUSTANG BAR AND PONY	M-1096-A	55
WHEEL CENTER CAP, RAPTOR/RANGER	M-1096K-RA	76
WHEEL KIT 19" X 10.5" (FRONT), 19" X 11" (REAR) - MATTE BLACK, 2015-2019 MUSTANG "HP" PERFORMANCE PACK	M-1007K-DC19XMB	29
WHEEL KIT WITH TPMS KIT AND TOOL, 2005-2019 FORD SUPER DUTY 20" X 8"	M-1007K-SU2008EB	76
WHEEL KIT WITH TPMS KIT AND TOOL, 2019 RANGER "RAPTOR" 17" X 8.5" DYNO GRAY	M-1007K-RGR1785OR	76
WHEEL LUG NUTS (5 PACK)	M-1012-G	47
WHEEL SET OF 4 WITH TPMS KIT, 2013-2018 FOCUS ST 19" X 8" MATTE GRAY	M-1007K-FST1908MG	63
WHEEL SET WITH TPMS KIT - GLOSS BLACK, 2012-2018 FOCUS ST 18" X 8"	M-1007K-M188GB	62
WHEEL SET WITH TPMS KIT - MATTE BLACK, 2015-2019 F-150 20" X 8.5" SIX SPOKE	M-1007K-P20XB	73
WHEEL SET WITH TPMS KIT - MATTE BLACK, 2015-2019 MUSTANG GT 19" X 9" & 19" X 9.5" PERFORMANCE PACK	M-1007K-M19XB	29
WHEEL SET WITH TPMS SENSOR KIT - GLOSS BLACK WITH MACHINED FACE, MUSTANG BOSS 302S 19" X 9"	M-1007KIT-DC199LGB	53
WHEEL SET WITH TPMS SENSOR KIT, MUSTANG BOSS 302S 19" X 9" FRONT, 19" X 10" REAR	M-1007KIT-DC19910LGB	53
WHEEL STUD AND NUT KIT - FRONT, MUSTANG/GT350 EXTENDED	M-1107-E	28
WHEEL STUD AND NUT KIT - REAR, MUSTANG/GT350 EXTENDED	M-1107-F	28
WHEEL W/O TPMS, 2013-2018 FOCUS ST 19" X 8" MATTE GRAY	M-1007-FST1908MG	63
WHEEL, 2015-2019 19" X 10" MUSTANG "HP" PERFORMANCE PACK MATTE BLACK	M-1007-DC1910MB	29
WHEEL, 2015-2019 19" X 10.5" MUSTANG "HP" PERFORMANCE PACK MATTE BLACK	M-1007-DC19105MB	29
WHEEL, 2015-2019 19" X 11" MUSTANG "HP" PERFORMANCE PACK MATTE BLACK	M-1007-DC1911MB	29
WHEEL, 2015-2019 19" X 9.5" MUSTANG "HP" PERFORMANCE PACK MATTE BLACK	M-1007-DC1995MB	29
WHEEL, 2019 RANGER "RAPTOR" 17" X 8.5" DYNO GRAY	M-1007-RGR1785OR	76
WHEEL, MUSTANG SHELBY GT500 18" X 9.5"	M-1007-S1895	54
WINDSHIELD BANNER, 2005-2019 MUSTANG "FORD PERFORMANCE"	M-1820-MB	25
WINDSHIELD BANNER, FOCUS "FORD PERFORMANCE"	M-1820-FFP	62
WINDSHIELD BANNER-WHITE AND RED, 2005-2019 MUSTANG "FORD PERFORMANCE"	M-1820-MR	25
X2347D STREET CRUISER-DRESSED CRATE ENGINE WITH X2 HEADS-FRONT SUMP PAN	M-6007-X2347DF	116
X2347D STREET CRUISER-DRESSED CRATE ENGINE WITH X2 HEADS-REAR SUMP PAN	M-6007-X2347DR	116
X-PIPE, 2005-2010 MUSTANG GT	M-5251-R	41
X-PIPE, 2011-2014 MUSTANG GT	M-5251-MGTA	41
X-PIPE, 2011-2014 MUSTANG V6	M-5251-MV6A	42
X-PIPE, 2015-2019 MUSTANG GT	M-5251-M8	13
Z2 289/302/351W ALUMINUM HEAD WITH VELOCITY VANE	M-6049-Z2	134

SUGGESTED RETAIL PRICE LIST

For the most up-to-date pricing and technical information, please visit performanceparts.ford.com

PART NUMBER	PART DESCRIPTION	PAGE	RETAIL PRICE
302-135	FORD RACING 289-351 SLANT EDGE VALVE COVER BLACK	188	\$320.00
302-135B	FORD RACING 289-351 SLANT EDGE VALVE COVER BLACK STEALTH	188	\$316.00
302-136	FORD RACING 289-351 SLANT EDGE VALVE COVER BLUE	189	\$320.00
302-137	FORD RACING 289-351 SLANT EDGE VALVE COVER GRAY	189	\$316.00
302-138	FORD RACING 289-351 SLANT EDGE VALVE COVER POLISHED	189	\$305.00
302-139	FORD RACING 289-351 SLANT EDGE VALVE COVER CHROME	189	\$425.00
302-999	SLANT EDGE FORD RACING AIR CLEANER	191	\$120.00
CM-19546-A1	FRICITION MODIFIER FOR CLUTCH-TYPE LIMITED-SLIP DIFFERENTIALS (SINGLE BOTTLES)	181	\$14.95
CM-6731-FL1A	FORD RACING HIGH PERFORMANCE OIL FILTER	133	\$16.95
CM-6731-FL820	FORD RACING HIGH PERFORMANCE OIL FILTER	133	\$16.95
M-1007-DC1785A	2019 F-150 RAPTOR BEAD-LOCK WHEEL KIT	74	Coming IQ 2020
M-1007-DC19105MB	2015-2019 19" x 10.5" MUSTANG "HP" PERFORMANCE PACK MATTE BLACK WHEEL	29	\$419.00
M-1007-DC1910LGB	MUSTANG BOSS 302S REAR WHEEL 19" X 10" - GLOSS BLACK WITH MACHINED FACE	53	\$295.00
M-1007-DC1910MB	2015-2019 19" x 10" MUSTANG "HP" PERFORMANCE PACK MATTE BLACK WHEEL	29	\$419.00
M-1007-DC1911MB	2015-2019 19" x 11" MUSTANG "HP" PERFORMANCE PACK MATTE BLACK WHEEL	29	\$419.00
M-1007-DC1995MB	2015-2019 19" x 9.5" MUSTANG "HP" PERFORMANCE PACK MATTE BLACK WHEEL	29	\$415.00
M-1007-DC199LGB	MUSTANG BOSS 302S FRONT WHEEL 19" X 9" - GLOSS BLACK WITH MACHINED FACE	53	\$295.00
M-1007-FST1908MG	2013-2018 FOCUS ST 19" x 8" Matte GRAY WHEEL W/O TPMS	63	\$245.00
M-1007K-DC19XMB	2015-2019 MUSTANG "HP" PERFORMANCE PACK WHEEL KIT 19" X 10.5" (FRONT), 19" X 11" (REAR) - MATTE BLACK	29	\$1,650.00
M-1007K-FST1908MG	2013-2018 FOCUS ST 19" x 8" Matte GRAY WHEEL SET OF 4 WITH TPMS KIT	63	\$1,050.00
M-1007KIT-DC19910LGB	MUSTANG BOSS 302S 19" X 9" FRONT, 19" X 10" REAR WHEEL SET WITH TPMS SENSOR KIT	53	\$1,200.00
M-1007KIT-DC199LGB	MUSTANG BOSS 302S 19" X 9" WHEEL SET WITH TPMS SENSOR KIT - GLOSS BLACK WITH MACHINED FACE	53	\$1,000.00
M-1007K-M188GB	2012-2018 FOCUS ST 18" X 8" WHEEL SET WITH TPMS KIT - GLOSS BLACK	62	\$1,147.00
M-1007K-M19XB	2015-2019 MUSTANG GT 19" x 9" & 19" x 9.5" PERFORMANCE PACK WHEEL SET WITH TPMS KIT - MATTE BLACK	29	\$1,420.00
M-1007K-P20XB	2015-2019 F-150 20" X 8.5" SIX SPOKE WHEEL SET WITH TPMS KIT - MATTE BLACK	73	\$1,467.00
M-1007K-RGR1785OR	2019 RANGER "RAPTOR" 17" X 8.5" DYNO GRAY WHEEL KIT WITH TPMS KIT AND TOOL	76	\$1,156.00
M-1007K-SU2008EB	2005-2019 FORD SUPER DUTY 20" X 8" WHEEL KIT WITH TPMS KIT AND TOOL	76	\$1,150.00
M-1007-M188GB	2012-2018 FOCUS ST 18" x 8" WHEEL - GLOSS BLACK	62	\$240.00
M-1007-M1995B	2015-2019 MUSTANG GT PERFORMANCE PACK REAR WHEEL 19" x 9.5" - MATTE BLACK	29	\$353.00
M-1007-M199B	2015-2019 MUSTANG GT PERFORMANCE PACK FRONT WHEEL 19" x 9" - MATTE BLACK	29	\$353.00
M-1007-P188MB	2005-2014 MUSTANG 18" X 8" MESH SPOKE WHEEL - MATTE BLACK	53	\$165.00
M-1007-P2085MB	2015-2019 F-150 20" x 8.5" SIX SPOKE WHEEL - MATTE BLACK	73	\$324.00
M-1007-R1986GB	2016-2018 MK3 FOCUS RS 19" X 8" WHEEL - GLOSS BLACK	62	\$260.00
M-1007-RGR1785OR	2019 RANGER "RAPTOR" 17" X 8.5" DYNO GRAY WHEEL	76	\$340.00
M-1007-S1895	MUSTANG SHELBY GT500 18" X 9.5" WHEEL	54	\$232.00
M-1007-W1785B	2017-2018 F-150 RAPTOR BEAD-LOCK WHEEL KIT	73	\$780.00
M-1012-A	FORD PERFORMANCE LUG NUT KIT	54	\$12.00
M-1012-FA	2015-2019 F-150 LUG NUT KIT	73	\$25.00
M-1012-G	WHEEL NUTS (5 PACK)	47	\$12.00
M-1012K-F15B	F-150 BLACK LUG NUT KIT	74	Coming IQ 2020
M-1012K-MB	2015-2019 MUSTANG/FORD GT BLACK LUG NUT VEHICLE KIT	28	\$233.00
M-1012-M	2015-2019 MUSTANG LUG NUT KIT	27	\$13.00
M-1012-MB	2015-2019 MUSTANG BLACK LUG NUTS	27	\$60.00
M-1012-N	2015-2019 MUSTANG OPEN BACK LUG NUT KIT	28	\$14.00
M-1012-RSA	MK2 FOCUS RS WHEEL LUG NUT KIT	63	\$15.00
M-1021-F15BL	2017-2018 RAPTOR BEAD LOCK WHEEL TRIM RING SET - BLUE	74	\$500.00

PART NUMBER	PART DESCRIPTION	PAGE	RETAIL PRICE
M-1021-F15BL1	2017-2018 RAPTOR BEAD LOCK WHEEL TRIM RING - BLUE	74	\$127.00
M-1021-F15OR	2017-2018 RAPTOR BEAD LOCK WHEEL TRIM RING SET - ORANGE	74	\$500.00
M-1021-F15OR1	2017-2018 RAPTOR BEAD LOCK WHEEL TRIM RING - ORANGE	74	\$127.00
M-1021-F15RA	2013-2014 F-150 RAPTOR BEAD LOCK RING KIT	74	\$199.00
M-1021-F15RB	2017-2018 F-150 RAPTOR BEAD LOCK RING KIT	74	\$216.00
M-1021-F15RD	2017-2018 RAPTOR BEAD LOCK WHEEL TRIM RING SET - RED	74	\$500.00
M-1021-F15RD1	2017-2018 RAPTOR BEAD LOCK WHEEL TRIM RING - RED	74	\$127.00
M-1021-RA1	2019 RAPTOR BEAD LOCK RING KIT	74	\$215.00
M-10300-COVER	FORD PERFORMANCE 5.0 SMART BATTERY CHARGER COVER	195	\$10.00
M-10300-FP	FORD PERFORMANCE 5.0 SMART BATTERY CHARGER & MAINTAINER	194	\$130.15
M-10665-A	FORD GT BATTERY CHARGER KIT-US SPEC	195	\$376.00
M-10665-B	FORD GT BATTERY CHARGER KIT-UK SPEC	195	\$952.38
M-10665-C	FORD GT BATTERY CHARGER KIT-EU SPEC	195	\$952.38
M-10849-A	2015-2018 MUSTANG PERFORMANCE PACK BOOST GAUGE KIT	187	\$295.00
M-10883-BFSE	FORD RACING COMPETITION GAUGES - Water Temp	187	\$109.72
M-1096-A	MUSTANG BAR AND PONY WHEEL CAP	55	\$30.00
M-1096-FP3	FORD PERFORMANCE WHEEL CENTER CAP	28	\$49.00
M-1096-FP3	FORD PERFORMANCE WHEEL CENTER CAP	55	\$49.00
M-1096-FR	FORD RACING CENTER CAP	55	\$60.00
M-1096-FR1	2005-14 FORD RACING WHEEL CENTER CAP	55	\$61.00
M-1096-K	FORD PERFORMANCE MUSTANG TRI-BAR CENTER CAP	55	\$60.00
M-1096K-RA	2017-2019 RAPTOR / RANGER WHEEL CENTER CAP SET	55	\$59.99
M-1096K-RA	RAPTOR/RANGER WHEEL CENTER CAP SET	76	\$59.99
M-1096-N	FORD PERFORMANCE SVT CENTER CAP	55	\$27.00
M-1096-O	2015-2019 MUSTANG WHEEL CENTER CAP - PONY EMBLEM	28	\$21.00
M-1096-O	2015-2019 MUSTANG WHEEL CENTER CAP - PONY EMBLEM	55	\$21.00
M-1096-Q	2012-2018 FOCUS WHEEL CENTER CAP	55	\$15.63
M-1096-Q	2012-2018 FOCUS WHEEL CENTER CAP	62	\$15.63
M-1096-RS	2016-2018 MK3 FOCUS RS CENTER CAP	55	\$51.00
M-1096-RS	2016-2018 MK3 FOCUS RS CENTER CAP	63	\$51.00
M-10B776-MR	2015-2017 MUSTANG RED STARTER BUTTON INSTALLATION KIT	26	\$50.00
M-11000-B51	HIGH TORQUE MINI STARTER - SMALL BLOCK	143	\$323.00
M-11000-C50	HIGH-TORQUE MINI STARTER - COYOTE & MODULAR ENGINES	102	\$285.00
M-11000-MT164	HIGH TORQUE MINI STARTER - SMALL BLOCK	143	\$339.00
M-1104-A	2005-2014 MUSTANG V6 / BOSS / GT / SHELBY GT500 HUB KIT WITH ARP STUDS	47	\$298.00
M-1104-AB	2015-2019 MUSTANG FRONT WHEEL HUB KIT WITH ARP STUDS	17	\$360.00
M-1104-B	2015-2019 MUSTANG REAR WHEEL HUB KIT WITH ARP STUDS	17	\$385.00
M-1104-SD	WARN UPGRADED LOCKING HUBS - BLACK	184	Coming IQ 2020
M-1107-C	2015-2019 MUSTANG EXTENDED ARP WHEEL STUD KIT	18	\$164.00
M-1107-E	MUSTANG/GT350 EXTENDED WHEEL STUD AND NUT KIT - FRONT	28	Coming IQ 2020
M-1107-F	MUSTANG/GT350 EXTENDED WHEEL STUD AND NUT KIT - REAR	28	Coming IQ 2020
M-1109-A	KIT CAR IRS HUB	177	\$225.00
M-1126-B	11" X 2.25" BRAKE DRUM	49	\$68.95
M-1180-A	MUSTANG AND FOCUS TPMS SENSOR AND ACTIVATION TOOL KIT	54	\$349.00
M-1180-B	2015-2019 MUSTANG AND F-150 TPMS SENSOR AND ACTIVATION TOOL KIT	30	\$215.00
M-1180-C	2015-2019 MUSTANG BLACK TPMS SENSOR AND ACTIVATION TOOL KIT	30	\$369.00
M-12000-M50	COYOTE ENGINE MANUAL TRANSMISSION UPFIT KIT	94	\$395.00
M-12000-M50A	COYOTE ENGINE AUTOMATIC TRANSMISSION UPFIT KIT	94	\$395.00
M-12000-M50B	GEN 3 ENGINE MANUAL TRANSMISSION UPFIT KIT	93	Coming IQ 2020
M-12029-3V	4.6L/5.4L 3V IGNITION COIL SET	111	\$325.00
M-12029-4V	2007-2014 MUSTANG SVT 4V IGNITION COIL SET	111	\$315.00
M-12029-M50C	EARLY 5.0L COYOTE ENGINE IGNITION COIL SET (8)	102	\$440.00

PART NUMBER	PART DESCRIPTION	PAGE	RETAIL PRICE
M-12029-M50E	LATE 5.0L COYOTE ENGINE IGNITION COIL SET (8)	103	\$310.00
M-12044-A2	CHROME IGNITION COIL BRACKET	192	\$11.25
M-1215-A	KIT CAR IRS BEARING	177	\$85.00
M-12259-C301	9MM SPARK PLUG WIRE SETS - "FORD RACING"	144	\$57.95
M-12259-C302	9MM SPARK PLUG WIRE SETS - "FORD RACING"	144	\$57.95
M-12259-C460	9MM SPARK PLUG WIRE SETS - "FORD RACING"	150	\$57.95
M-12259-C462	9MM SPARK PLUG WIRE SETS - "FORD RACING"	111	\$98.50
M-12259-C464	9MM SPARK PLUG WIRE SETS - "FORD RACING"	111	\$122.95
M-12259-M301	9MM SPARK PLUG WIRE SETS - "FORD RACING"	144	\$57.95
M-12259-M302	9MM SPARK PLUG WIRE SETS - "FORD RACING"	144	\$57.95
M-12259-R301	9MM SPARK PLUG WIRE SETS - "FORD RACING"	144	\$57.95
M-12259-R460	9MM SPARK PLUG WIRE SETS - "FORD RACING"	150	\$57.95
M-12259-R462	9MM SPARK PLUG WIRE SETS - "FORD RACING"	111	\$98.50
M-12259-R464	9MM SPARK PLUG WIRE SETS - "FORD RACING"	111	\$122.95
M-12259-T462	9MM SPARK PLUG WIRE SETS - "FORD RACING"	111	\$98.50
M-1225-B	8.8" OUTER AXLE BEARING AND SEAL KIT	179	\$44.00
M-1225-BI	8.8" AXLE BEARING AND SEAL KIT	179	\$54.95
M-12270-A302	DISTRIBUTOR HOLD-DOWN CLAMP	192	\$8.95
M-12297-L900	CUSTOM BILLET WIRE LOOMS	192	\$125.00
M-12405-20T	2013-2018 FOCUS ST/RS/MUSTANG ECOBOOST COLD SPARK PLUG SET	57	\$91.00
M-12405-35T	2010-2017 3.5L ECOBOOST® COLD SPARK PLUG SET	94	\$54.00
M-12405-3V0A	3V COLD SPARK PLUG (16 MM THREAD)	112	\$130.00
M-12405-3V12MM	3V COLD SPARK PLUG SET (12 MM THREAD)	111	\$100.00
M-12405-M50A	PERFORMANCE 5.0L COYOTE COLD SPARK PLUG SET	101	\$75.00
M-12508-M50	5.0L COYOTE ENGINE HARNESS	162	\$395.00
M-12508-M50A	5.0L COYOTE AUTO TRANS ENGINE HARNESS	162	\$325.00
M-12579-L54	2001-2004 F-150 LIGHTNING MASS AIR METER	165	\$269.00
M-12A227-CJ13	5.0L COYOTE HIGH RPM COMPETITION PULSE RING	103	\$115.00
M-13086-MD	2006-09 MUSTANG GRAY FLOOR MATS "MUSTANG" TAG	52	\$87.00
M-13086-ME	2006-09 MUSTANG BLACK FLOOR MATS "MUSTANG" TAG	52	\$87.00
M-13086-MF	2010 MUSTANG BLACK FLOOR MAT SILVER PONY	52	\$87.00
M-13086-MG	2010 MUSTANG GT500 GRAY FLOOR MATS	52	\$87.00
M-13086-MH	2012 MUSTANG BLACK FLOOR MATS SILVER PONY	52	\$87.00
M-13086-MJ	2012 MUSTANG BLACK FLOOR MATS "BOSS 302"	52	\$87.00
M-13086-MM	2013-14 MUSTANG BLACK FLOOR MATS "BOSS 302"	52	\$104.00
M-13086-MN	2013-14 MUSTANG BLACK FLOOR MAT SILVER PONY	52	\$104.00
M-13086-MP	2013-14 MUSTANG GRAY FLOOR MATS "GT500"	52	\$104.00
M-14204-FSTA	2013-2018 FOCUS ST CALIBRATION AND SPARK PLUGS	57	\$620.00
M-14204-MGTTTC	2013-2014 MUSTANG GT TRACK CAL CALIBRATION	38	\$609.00
M-14204-MGTTTCU	2013-2014 MUSTANG GT TRACK CAL UPDATE	38	\$135.00
M-1447-A	2015-2019 DASH EMBLEM	193	\$69.00
M-1447-C	2007-2009 MUSTANG SVT 'COBRA' SNAKE FENDER EMBLEMS	192	\$88.00
M-1447-D46	1996-1998 COBRA INTAKE PLAQUE	191	\$9.50
M-1447-EBBLK	ECOBOOST EMBLEMS/BADGES-BLACK AND SILVER-PAIR	193	\$39.00
M-1447-EBBLKLG	ECOBOOST EMBLEMS/BADGES-BLACK AND CHROME-LARGE SIZE-PAIR	193	\$49.00
M-1447-EBLG	ECOBOOST EMBLEMS/BADGES-SILVER-LARGE SIZE-PAIR	193	\$49.00
M-1447-F46	1999-2001 COBRA INTAKE PLAQUE	191	\$14.50
M-1447-M50	2011-2014 MUSTANG 5.0L FENDER EMBLEMS/BADGES-CHROME-PAIR	192	\$34.95
M-1447-M50A	2015-2019 MUSTANG 5.0L FENDER EMBLEMS/BADGES-CHROME-PAIR	192	\$35.00
M-1447-M50AB	2015-2019 MUSTANG 5.0L FENDER EMBLEMS/BADGES-BLACK-PAIR	192	\$39.00
M-1447-SR	1994-2004 COBRA SNAKE FENDER EMBLEMS	192	\$18.00
M-1447-SVT	SVT DECKLID EMBLEM/BADGE	192	\$14.50
M-15200K-R	2019 RANGER 40" RIGID LED LIGHT BAR KIT	76	\$910.00
M-15200-RFL	2017-2019 RAPTOR SAE LED FOG LIGHT KIT	73	Coming 1Q 2020
M-15200-RFOG	2019 RANGER OFF-ROAD FOG LIGHT KIT	75	\$479.00
M-15200-RHM	RANGER HOOD HINGE-MOUNTED OFF-ROAD LIGHT KIT	75	Coming 1Q 2020
M-15200-RUN	OFF-ROAD UNDER BODY/ROCK LIGHT KIT	76	\$379.00
M-16098-CJG	COBRA JET GRILLE EMBLEM	193	\$99.00
M-16098-PBFP	"POWERED BY FORD PERFORMANCE" BADGE	193	\$99.00
M-1613208-A	2015-2019 MUSTANG "FORD PERFORMANCE" SILL PLATE SET	26	\$200.00
M-1613208-F15A	2015-2019 F-150 "FORD PERFORMANCE" SILL PLATE SET	71	\$105.55
M-16450-F15RA	RAPTOR/F-150 SUPERCREW ROCK SLIDER SIDE STEPS	71	\$1,512.00

PART NUMBER	PART DESCRIPTION	PAGE	RETAIL PRICE
M-16450-F15RAB	RAPTOR/F-150 SUPERCREW ROCK SLIDER SIDE STEPS	71	\$1,512.00
M-16450-F15RAC	2015-2019 F-150/RAPTOR RACE SIDE STEPS - SUPERCREW	71	\$1,069.00
M-16450-F15RAD	2015-2019 F-150/RAPTOR RACE SIDE STEPS - SUPERCAB	71	\$1,069.00
M-16600-MA	2015-2019 MUSTANG DECK LID TRIM PANEL	26	\$207.00
M-16600-SVTC	2005-2009 MUSTANG SVT REAR SPOILER	50	\$265.00
M-16601H-MB	2010-2012 SPLITTER HARDWARE KIT	50	\$294.00
M-16601H-S	BOSS 302S FRONT SPLITTER HARDWARE KIT	50	\$379.00
M-16601-MBA	2013-2014 BOSS LAGUNA SECA FRONT SPLITTER KIT	50	\$904.00
M-16700-A	HOOD LATCH & PIN KIT	192	\$45.00
M-16700-S	COBRA JET AND FR500S HOOD PIN KIT	192	\$70.00
M-16826-M	2005-2014 MUSTANG HOOD LIFT KIT W/ LASER ENGRAVED "FORD PERFORMANCE" LOGO	51	\$99.00
M-16826-MA	2015-2019 MUSTANG HOOD LIFT KIT W/ LASER ENGRAVED "FORD PERFORMANCE" LOGO	26	\$102.00
M-1700-M	2015-2019 MUSTANG TIE DOWN KIT	27	\$104.00
M-17757-MB	2005-2014 MUSTANG LIGHTWEIGHT TUBULAR FRONT BUMPER	51	\$335.58
M-17757-RIF	2019 RANGER OFF-ROAD BUMPER - FRONT	75	Coming 1Q 2020
M-17954-A	TOW HOOK LOOP KIT	51	\$60.00
M-17954-F	MUSTANG FRONT TOW RING KIT	51	\$77.00
M-17954-FA	2015-2019 GT350 FRONT TOW HOOK ASSEMBLY	28	\$88.00
M-17954-RA	MUSTANG REAR TOW RING KIT	51	\$77.00
M-17954-RB	2015-2019 MUSTANG REAR TOW HOOK ASSEMBLY	28	\$110.00
M-18000-A	2005-2014 MUSTANG COUPE DYNAMIC STRUT/SHOCK KIT	43	\$764.00
M-18000-C	2005-2014 MUSTANG GT / 2007-2014 SVT ADJUSTABLE STRUT/SHOCK KIT	43	\$915.00
M-18000-F	2015-2019 MUSTANG TRACK STRUT AND SHOCK KIT	19	\$698.00
M-18000-F15A	2015-2018 F-150 FOX "TUNED BY FORD PERFORMANCE" 2.0 IFF OFF-ROAD SUSPENSION KIT	69	\$1,495.00
M-18000-F15R	2017-2018 RAPTOR FOX FACTORY RACE SERIES 3.0 FRONT & REAR SHOCK UPGRADE KIT	70	\$6,795.00
M-18000-R	RANGER OFF-ROAD SUSPENSION DAMPER KIT	75	\$1,495.00
M-18000-ZX3	2000-2005 SVT FOCUS STRUT/SHOCK KIT	60	\$242.00
M-18000-ZX3B	2006-2007 FOCUS PERFORMANCE SHOCK/STRUT KIT	60	\$267.00
M-18001-AF	SINGLE FRONT SERVICE REPLACEMENT STRUT FOR - M-18000-A	43	\$200.00
M-18001-AG	2015-2019 MUSTANG FR3 TRACK SUSPENSION SINGLE FRONT SERVICE STRUT	19	\$197.00
M-18001-ARI	SINGLE REAR SERVICE REPLACEMENT STRUT FOR - M-18000-A	43	\$184.00
M-18001-AS	2015-2019 MUSTANG FR3 TRACK SUSPENSION SINGLE REAR SERVICE SHOCK	19	\$199.00
M-18183-C	2005-2014 MUSTANG FRONT STRUT MOUNT UPGRADE (PAIR)	44	\$159.00
M-18183-M	2015-2019 MUSTANG FRONT STRUT MOUNT (PAIR)	20	\$164.00
M-18197-A	MUSTANG REAR UPPER SHOCK MOUNT	44	\$86.00
M-1820-FFP	FOCUS "FORD PERFORMANCE" WINDSHIELD BANNER	62	\$40.00
M-1820-FP	"FORD PERFORMANCE" DECAL - 10 PACK	194	\$15.00
M-1820-FPORRH	FORD PERFORMANCE BY WARN® INDUSTRIES OFF-ROAD RECOVERY KIT-HEAVY DUTY	71	\$329.00
M-1820-MB	2005-2019 MUSTANG "FORD PERFORMANCE" WINDSHIELD BANNER	25	\$47.00
M-1820-MR	2005-2019 MUSTANG "FORD PERFORMANCE" WINDSHIELD BANNER-WHITE AND RED	25	\$53.00
M-1822-A7	"FORD PERFORMANCE" FENDER COVER	193	\$19.95
M-1822-A8	"FORD PERFORMANCE" TRACK MAT	193	\$49.95
M-1822-A9	"FORD PERFORMANCE" TIRE SHADE	193	\$50.00
M-1822-M	2015-2017 MUSTANG FENDER COVERS (PAIR)	29	\$175.00
M-1827-FP	"FORD PERFORMANCE" BANNER	194	\$35.00
M-1827-P1	"FORD RACING" 50-FT. PENNANT STRING	194	\$17.00
M-1827-P2	"FORD PERFORMANCE" 50 - FT. PENNANT STRING	194	\$80.00
M-1827-T10A	FORD PERFORMANCE 10'X10' EZ-UP TENT	195	\$780.00
M-1827-T20A	FORD PERFORMANCE 10' x 20' E-Z UP TENT	195	\$1,270.00
M-1827-W10A	FORD PERFORMANCE E-Z UP TENT SIDE WALLS 10'	195	\$195.00
M-1828-FPONE	"FORD PERFORMANCE" LICENSE PLATE - SINGLE	193	\$15.00
M-1828-SS304BK	BLACK STAINLESS STEEL FORD PERFORMANCE LICENSE PLATE FRAME	194	\$35.00
M-1828-SS304C	STAINLESS STEEL "FORD PERFORMANCE" LICENSE PLATE FRAME	194	\$35.00
M-1828-SSB	LICENSE PLATE FRAME - BLACK POWDERCOAT	194	\$35.00
M-1828-SSC	LICENSE PLATE FRAME - BBRUSHED STAINLESS-STEEL	194	\$35.00
M-1830-FPAC	FORD PERFORMANCE OFF ROAD/TRACK AIR COMPRESSOR KIT	195	\$369.00

PART NUMBER	PART DESCRIPTION	PAGE	RETAIL PRICE
M-1830-FP0RR	FORD PERFORMANCE BY WARN® INDUSTRIES OFF-ROAD RECOVERY KIT	71	\$149.00
M-18954-RA	2019 RANGER TOW HOOKS-PAIR-RED	76	\$109.00
M-18954-RAB	2019 RANGER TOW HOOKS-PAIR-BLUE	76	\$109.00
M-19007-A	2017-2019 RAPTOR/F-150 RACE SERIES REAR CHASE RACK WITH LIGHT BAR ACTUATOR	72	\$2,900.00
M-19007-B	2017-2019 RAPTOR CHASE RACK/ROOF RACK	72	\$4,450.00
M-19007-BC	2017-2019 RAPTOR CHASE RACK IN-BED TIRE CARRIER	72	\$1,175.00
M-19007-F15R	F-150/RAPTOR FORD PERFORMANCE CHASE RACK	72	Coming IQ 2020
M-19007-R	2019 RANGER FORD PERFORMANCE CHASE RACK	75	\$1,496.00
M-19007-SD	2017-2019 SUPER DUTY FORD PERFORMANCE CHASE RACK	72	Coming IQ 2020
M-19216-A50	1994-1995 MUSTANG GT A/C ELIMINATOR KIT	143	\$72.00
M-19216-D46	1996-2010 MUSTANG A/C ELIMINATOR KIT	110	\$65.00
M-19546-A12	FRICTION MODIFIER FOR CLUTCH-TYPE LIMITED-SLIP DIFFERENTIALS (CASE OF 12 BOTTLES)	181	\$129.00
M-20045-MSVT	2005-2014 MUSTANG HIGH PERFORMANCE BRAKE COOLING SHIELDS	50	\$70.00
M-2004-FRS	2013-2018 FOCUS ST FRONT BRAKE COOLING DEFLECTOR KIT	61	\$125.00
M-2005-R	MUSTANG FR500C, BOSS 302R/S BRAKE BOOSTER	50	\$2,900.00
M-2007-FRIV6	2005-2009 MUSTANG V6 POWER UPGRADE PACKAGE	35	\$1,430.00
M-20201-F	2005-2014 MUSTANG V6 STRUT TOWER BRACE	46	\$251.00
M-20201-GT350	2015-2019 MUSTANG GT350R STRUT TOWER BRACE KIT	23	\$387.00
M-20201-M350RHD	2015-2017 MUSTANG GT350R RIGHT HAND DRIVE STRUT TOWER BRACE KIT	23	\$425.00
M-20201-MA	2015-2019 MUSTANG FORD PERFORMANCE STRUT TOWER BRACE	23	\$223.00
M-20201-MARHD	2015-2017 MUSTANG RIGHT HAND DRIVE STRUT TOWER BRACE	23	\$325.00
M-20201-S197	2005-2014 MUSTANG GT STRUT TOWER BRACE	46	\$212.00
M-2078-MB	2005-2014 MUSTANG BRAKE LINE UPGRADE KIT	50	\$103.00
M-2300-AA	2015-2019 GT350 BRAKE UPGRADE KIT	24	\$3,159.00
M-2300-BUL	S550 MUSTANG BULLITT™ BRAKE KIT	25	\$2,695.00
M-2300-D	2005-2010 MUSTANG V6 FRONT BRAKE UPGRADE KIT	48	\$199.00
M-2300-G2	5-LUG REAR DISC BRAKE KIT LATE MODEL FORD 9-INCH TRUCK AXLE HOUSING	182	\$359.00
M-2300-M	1994-2004 MUSTANG GT REAR BRAKE BRACKET UPGRADE KIT	49	\$435.00
M-2300-MR	2015-2017 MUSTANG REAR BRAKE KIT	24	\$575.00
M-2300-S	2005-2014 MUSTANG GT 14" SVT BRAKE UPGRADE KIT	49	\$1,550.00
M-2300-SA	2005-2014 MUSTANG GT 14" SVT BRAKE UPGRADE KIT w/ 2-PIECE ROTORS	49	\$2,250.00
M-2300-T	2005-2014 MUSTANG SIX PISTON 15-INCH BRAKE UPGRADE KIT	49	\$2,850.00
M-2300-V	2015-2019 MUSTANG PERFORMANCE PACK 6-PISTON FRONT BRAKE KIT	25	\$1,747.00
M-2300-W	2013-2018 FOCUS ST PERFORMANCE FRONT RS BRAKE UPGRADE KIT	61	\$1,113.00
M-2300-WR	2013-2018 FOCUS ST PERFORMANCE REAR RS BRAKE UPGRADE KIT	61	\$440.00
M-2300-X	1994-2004 MUSTANG COBRA R FRONT BRAKE UPGRADE KIT	49	\$1,586.00
M-2300-XP	1994-2004 FORD PERFORMANCE COBRA R FRONT BRAKE UPGRADE M-2300-X BRAKE PAD REPLACEMENT KIT	49	\$156.00
M-2300-XR	1994-2004 FORD PERFORMANCE COBRA R FRONT BRAKE UPGRADE M-2300-X BRAKE ROTOR REPLACEMENT KIT	49	\$485.00
M-2300-Y	2015-2019 MUSTANG PERFORMANCE GT350R BRAKE KIT	25	\$5,040.00
M-2301-A	ALUMINUM AND URETHANE SPECIAL EDITION MUSTANG PEDAL COVER - ACCELERATOR PEDAL COVER	52	\$26.00
M-2301-B	ALUMINUM AND URETHANE SPECIAL EDITION MUSTANG PEDAL COVER - BRAKE / CLUTCH PEDAL COVER	52	\$23.95
M-2301-BA	MUSTANG BRUSHED PEDAL KIT FOR AUTOMATIC	26	Coming IQ 2020
M-2301-BM	MUSTANG BRUSHED PEDAL KIT FOR MANUAL TRANSMISSION	26	\$139.00
M-2301-C	ALUMINUM AND URETHANE SPECIAL EDITION MUSTANG DEAD PEDAL - DEAD PEDAL	52	\$21.00
M-2328-C	BRAKE PROPORTIONING VALVE	50	\$56.50
M-2780-FRS	2016-2018 FOCUS RS DRIFT STICK	59	\$999.00
M-2810-A	ADJUSTABLE PARKING BRAKE CABLE	50	\$37.00
M-3000-G	2004-2014 F-150 REAR LOWERING KIT	69	\$119.00

PART NUMBER	PART DESCRIPTION	PAGE	RETAIL PRICE
M-3000-H4A	2015-2019 F-150 COMPLETE LOWERING KIT	69	\$487.00
M-3000-HA	2015-2019 F-150 REAR LOWERING KIT	69	\$133.00
M-3000-ZX3	2000-2005 FOCUS SUSPENSION KIT	60	\$364.00
M-3000-ZX3A	2000-2005 FOCUS ASSEMBLED SUSPENSION KIT	60	\$444.00
M-3075-A	1979-1993 MUSTANG / CAPRI FRONT LOWER CONTROL ARM KIT	47	\$354.00
M-3075-E	2005-2010 MUSTANG GT FRONT LOWER CONTROL ARM UPGRADE KIT	46	\$430.00
M-3075-F	2015-2019 MUSTANG PERFORMANCE PACK FRONT CONTROL ARM KIT	21	\$355.00
M-3075-RA	2011-2014 MUSTANG FRONT CONTROL ARM KIT W/ EXTENDED BALL JOINT	46	\$706.00
M-3130-R4	2005-2014 MUSTANG BUMP STEER KIT	47	\$239.00
M-3200-EPAS	BOSS 302R ELECTRIC STEERING RACK	46	\$1,175.00
M-3600-F15ROR	2015-2018 F-150 RAPTOR PERFORMANCE STEERING WHEEL KIT - ORANGE SIGHTLINE	70	\$573.00
M-3600-F15RRD	2015-2018 F-150 RAPTOR PERFORMANCE STEERING WHEEL KIT - RED SIGHTLINE	70	\$540.00
M-3600-FRS	2015-2018 FOCUS ST PERFORMANCE RS STEERING WHEEL KIT	62	\$243.00
M-3600-RA	FORD PERFORMANCE STEERING WHEEL - OFF-ROAD	52	\$314.00
M-3602-R	STEERING WHEEL HUB ADAPTER	52	\$100.00
M-3A331-GT4A	GT4 CV BOOT LH	184	\$99.00
M-3A331-GT4B	GT4 CV BOOT RH	184	\$99.00
M-3B236-A	2005-2014 MUSTANG CASTER AND CAMBER ALIGNMENT ECCENTRIC BOLT KIT	46	\$99.00
M-4000-M8S	GT350 DIFFERENTIAL COOLER KIT	18	\$2,495.00
M-4001-88355B	2015-2019 MUSTANG SUPER 8.8" IRS LOADED DIFFERENTIAL HOUSING - 3.55	19	\$1,095.00
M-4026-FA	2014-2017 FIESTA ST QUAIFE TORQUE BIASING DIFFERENTIAL INSTALLATION KIT	60	\$221.00
M-4026-FST	2013-2017 FOCUS ST QUAIFE TORQUE BIASING DIFFERENTIAL INSTALLATION KIT	60	\$157.00
M-4033-F975	9.75" F-150 Raptor Differential Cover	181	\$271.00
M-4033-G2	8.8" AXLE GIRDLE COVER KIT	177	\$259.00
M-4033-G3	1999-2004 COBRA IRS AXLE GIRDLE COVER	178	\$319.00
M-4033-KA	8.8" ALUMINUM AXLE COVER WITH DIFFERENTIAL COOLER PORTS	178	\$255.00
M-4033-R	RANGER FORD PERFORMANCE DIFFERENTIAL COVER KIT	74	\$271.00
M-4050-B	1979-2004 MUSTANG 8.8" AXLE INSTALLATION KIT	178	\$45.00
M-4130-M8S	2015-2018 MUSTANG GT350 HALF SHAFT KIT	20	\$440.00
M-4130-MA	2015-2018 MUSTANG HALF SHAFT UPGRADE KIT	20	\$2,400.00
M-4138-MA	2015-2018 MUSTANG HALF SHAFT ASSEMBLY (RIGHT SIDE)	20	\$1,090.00
M-4139-MA	2015-2018 MUSTANG HALF SHAFT ASSEMBLY (LEFT SIDE)	20	\$1,090.00
M-4141-HS	9" STEEL DIFFERENTIAL CARRIER	182	\$895.00
M-4144-B	9" DIFFERENTIAL BEARING ADJUSTER LOCK AND BOLT KIT	182	\$6.50
M-4204-F150LS	8.8" FRONT AXLE LIMITED SLIP TORSEN® DIFFERENTIAL	69	\$850.00
M-4204-F150LS	8.8" FRONT AXLE LIMITED SLIP TORSEN® DIFFERENTIAL	181	\$850.00
M-4204-F28A	9" TRAC-LOK LIMITED SLIP DIFFERENTIAL	182	\$565.00
M-4204-F318C	8.8" TRACTION-LOK LIMITED SLIP DIFFERENTIAL	181	\$400.00
M-4204-F31A	9" TRAC-LOK LIMITED SLIP DIFFERENTIAL	182	\$565.00
M-4204-M	2015-2019 MUSTANG SUPER 8.8-INCH TRACTION-LOK DIFFERENTIAL	19	\$210.00
M-4204-MB	2012-2013 MUSTANG BOSS 302 TORSEN DIFFERENTIAL	181	\$1,079.00
M-4204-MT	2015-2019 MUSTANG GT SUPER 8.8 TORSEN DIFFERENTIAL	19	\$900.00
M-4204-T31	8.8" T-2 TORSEN DIFFERENTIALS	181	\$739.00
M-4204-T31H	MUSTANG FR500S DIFFERENTIAL	181	\$1,020.00
M-4209-88308	8.8" 3.08 RING GEAR AND PINION	178	\$285.00
M-4209-88315	8.8" 3.15 RING GEAR AND PINION	178	\$265.00
M-4209-88327	8.8" 3.27 RING GEAR AND PINION	178	\$265.00
M-4209-88331	8.8" 3.31 RING GEAR AND PINION	178	\$265.00
M-4209-88355	8.8" 3.55 RING GEAR AND PINION	178	\$259.00
M-4209-88355A	MUSTANG IRS SUPER 8.8-INCH RING AND PINION SET - 3.55 RATIO	179	\$260.00
M-4209-88373	8.8" 3.73 RING GEAR AND PINION	178	\$265.00
M-4209-88373A	MUSTANG IRS SUPER 8.8-INCH RING AND PINION SET - 3.73 RATIO	179	\$260.00
M-4209-88373B	MUSTANG IRS SUPER 8.8-INCH RING AND PINION SET - 3.73 RATIO	179	\$335.00
M-4209-88409A	2015-2019 MUSTANG IRS SUPER 8.8-INCH RING AND PINION SET - 4.09 RATIO	179	\$359.00
M-4209-88410	8.8" 4.10 RING GEAR AND PINION	178	\$265.00
M-4209-88410F	8.8" 4X4 FRONT 4.10 RING GEAR AND PINION	70	\$260.00

PART NUMBER	PART DESCRIPTION	PAGE	RETAIL PRICE
M-4209-88410F	8.8" 4.10 RING GEAR AND PINION FOR 4X4 FT AXLE	179	\$260.00
M-4209-88456	8.8" 4.56 RING GEAR AND PINION	178	\$335.00
M-4210-A	8.8" RING & PINION INSTALLATION KIT	180	\$49.00
M-4210-B2	8.8" RING GEAR AND PINION INSTALLATION KIT	180	\$159.00
M-4210-B3	2015-2019 SUPER 8.8" IRS RING AND PINION INSTALLATION KIT	18	\$180.00
M-4210-B75	7.5" RING GEAR AND PINION INSTALLATION KIT	180	\$129.00
M-4210-C3	8.8" RING AND PINION INSTALLATION KIT	180	\$149.00
M-4210-RF	RANGER RING AND PINION INSTALLATION KIT-FRONT AXLE	74	\$359.00
M-4213-A	UNIVERSAL PINION NUT	178	\$145.00
M-4216-A200	BOLT - 9" RING GEAR TO DIFFERENTIAL CASE (PACKAGE OF 100)	182	\$249.00
M-4216-A210	BOLT - 9" RING GEAR TO DIFFERENTIAL CASE (PACKAGE OF 10)	182	\$26.50
M-4216-A300	8.8" RING GEAR BOLT SET	172	\$11.50
M-4216-C	SUPER 8.8 RING GEAR BOLT KIT (10 PIECES)	19	\$13.95
M-4264-A	2005-2014 MUSTANG ADJUSTABLE PANHARD BAR	47	\$282.00
M-4266-A	2005-2014 MUSTANG ADJUSTABLE PANHARD BAR BUSHING KIT	48	\$35.00
M-4413-A	8.8" IRS BEARING AND SEAL KIT	179	\$44.00
M-4413-B	MUSTANG SUPER 8.8 IRS BEARING & SEAL KIT	19	\$37.00
M-4602-GA	HD ALUMINUM DRIVESHAFT ASSEMBLY - 28 SPLINE	183	\$555.00
M-4602-JA	HD ALUMINUM DRIVESHAFT ASSEMBLY - 31 SPLINE	183	\$499.00
M-4602-MGTA	2005-2010 MUSTANG GT ONE-PIECE DRIVESHAFT	183	\$799.00
M-4602-MGTM	2011-2014 MUSTANG GT ONE-PIECE DRIVESHAFT	183	\$829.00
M-4602-MSVT	2007-2012 MUSTANG GT500 ONE-PIECE DRIVESHAFT	183	\$849.00
M-4602-S	BOSS 302R DRIVESHAFT	183	\$480.00
M-4614-B	9-INCH "DAYTONA" PINION BEARING RETAINER	183	\$119.00
M-4635-A	SPECIAL U-JOINT KIT	183	\$50.00
M-4676-A111	"BENDA" PINION SEAL 9" AXLE	182	\$19.95
M-4700-B	8.8" TRACTION-LOK REBUILD KIT	180	\$105.00
M-4700-C	8.8" TRACTION-LOK REBUILD KIT WITH CARBON DISCS	181	\$165.00
M-4841-A	DRIVESHAFT YOKE 31 SPLINE	183	\$109.00
M-4841-B	28 SPLINE DRIVESHAFT SLIP YOKE	183	\$85.00
M-4851-B	2003-2004 COBRA PINION FLANGE	179	\$64.00
M-4851-C	PINION FLANGE 8.8-INCH AXLE	179	\$54.00
M-4851-M8A	2015-2019 MUSTANG AUTOMATIC IRS PINION FLANGE	18	\$80.00
M-5018-F15RB	2017-2019 F-150 RAPTOR SKID PLATE KIT	73	\$1,187.00
M-5025-A	2005-2009 MUSTANG GT COUPE FRONT LOWER A-ARM BRACE UPGRADE KIT	47	\$63.75
M-5025-MBR	MUSTANG BOSS 302 MANUAL TRANS COOLER AIR SCOOP	171	\$155.00
M-5059-A	ADJUSTABLE #3 CROSSMEMBER	171	\$78.50
M-5200-F1527DEBA	2015-2019 F-150 2.7L CAT-BACK EXTREME EXHAUST SYSTEM - REAR EXIT, BLACK CHROME TIPS	66	\$1,395.00
M-5200-F1527DECA	2015-2019 F-150 2.7L CAT-BACK EXTREME EXHAUST SYSTEM - REAR EXIT, CHROME TIPS	66	\$1,395.00
M-5200-F1527DEFA	2015-2019 F-150 2.7L CAT-BACK EXTREME EXHAUST SYSTEM - REAR EXIT, CARBON FIBER TIPS	66	\$1,575.00
M-5200-F1527DSBA	2015-2019 F-150 2.7L CAT-BACK SPORT EXHAUST SYSTEM - REAR EXIT, BLACK CHROME TIPS	66	\$1,395.00
M-5200-F1527DSCA	2015-2019 F-150 2.7L CAT-BACK SPORT EXHAUST SYSTEM - REAR EXIT, CHROME TIPS	66	\$1,395.00
M-5200-F1527DSFA	2015-2019 F-150 2.7L CAT-BACK SPORT EXHAUST SYSTEM - REAR EXIT, CARBON FIBER TIPS	66	\$1,630.00
M-5200-F1527DTBA	2015-2019 F-150 2.7L CAT-BACK TOURING EXHAUST SYSTEM - REAR EXIT, BLACK CHROME TIPS	66	\$1,395.00
M-5200-F1527DTCA	2015-2019 F-150 2.7L CAT-BACK TOURING EXHAUST SYSTEM - REAR EXIT, CHROME TIPS	66	\$1,395.00
M-5200-F1527DTFA	2015-2019 F-150 2.7L CAT-BACK TOURING EXHAUST SYSTEM - REAR EXIT, CARBON FIBER TIPS	66	\$1,630.00
M-5200-F1527REBA	2015-2019 F-150 2.7L CAT-BACK EXTREME EXHAUST SYSTEM - SIDE EXIT, BLACK CHROME TIPS	66	\$1,395.00
M-5200-F1527RECA	2015-2019 F-150 2.7L CAT-BACK EXTREME EXHAUST SYSTEM - SIDE EXIT, CHROME TIPS	66	\$1,395.00
M-5200-F1527RSBA	2015-2019 F-150 2.7L CAT-BACK SPORT EXHAUST SYSTEM - SIDE EXIT, BLACK CHROME TIPS	66	\$1,395.00
M-5200-F1527RSCA	2015-2019 F-150 2.7L CAT-BACK SPORT EXHAUST SYSTEM - SIDE EXIT, CHROME TIPS	66	\$1,395.00
M-5200-F1527RTBA	2015-2019 F-150 2.7L CAT-BACK TOURING EXHAUST SYSTEM - SIDE EXIT, BLACK CHROME TIPS	66	\$1,395.00
M-5200-F1527RTCA	2015-2019 F-150 2.7L CAT-BACK TOURING EXHAUST SYSTEM - SIDE EXIT, CHROME TIPS	66	\$1,395.00
M-5200-F1535126L	2014 F-150 TREMOR 3.5L CAT-BACK SPORT EXHAUST SYSTEM - SIDE EXIT, CHROME TIPS	68	\$1,249.00
M-5200-F1535145L	2011-2014 F-150 3.5L ECOBOOST CAT-BACK SPORT EXHAUST SYSTEM - 145" WB	68	\$1,195.00

PART NUMBER	PART DESCRIPTION	PAGE	RETAIL PRICE
M-5200-F1535DEBA	2015-2019 F-150 3.5L CAT-BACK EXTREME EXHAUST SYSTEM - REAR EXIT, BLACK CHROME TIPS	66	\$1,395.00
M-5200-F1535DECA	2015-2019 F-150 3.5L CAT-BACK EXTREME EXHAUST SYSTEM - REAR EXIT, CHROME TIPS	66	\$1,395.00
M-5200-F1535DEFA	2015-2019 F-150 3.5L CAT-BACK EXTREME EXHAUST SYSTEM - REAR EXIT, CARBON FIBER TIPS	66	\$1,575.00
M-5200-F1535DSBA	2015-2019 F-150 3.5L CAT-BACK SPORT EXHAUST SYSTEM - REAR EXIT, BLACK CHROME TIPS	66	\$1,395.00
M-5200-F1535DSCA	2015-2019 F-150 3.5L CAT-BACK SPORT EXHAUST SYSTEM - REAR EXIT, CHROME TIPS	66	\$1,395.00
M-5200-F1535DSFA	2015-2019 F-150 3.5L CAT-BACK SPORT EXHAUST SYSTEM - REAR EXIT, CARBON FIBER TIPS	66	\$1,630.00
M-5200-F1535DTBA	2015-2019 F-150 3.5L CAT-BACK TOURING EXHAUST SYSTEM - REAR EXIT, BLACK CHROME TIPS	66	\$1,395.00
M-5200-F1535DTCA	2015-2019 F-150 3.5L CAT-BACK TOURING EXHAUST SYSTEM - REAR EXIT, CHROME TIPS	66	\$1,395.00
M-5200-F1535DTFA	2015-2019 F-150 3.5L CAT-BACK TOURING EXHAUST SYSTEM - REAR EXIT, CARBON FIBER TIPS	66	\$1,630.00
M-5200-F1535REBA	2015-2019 F-150 3.5L CAT-BACK EXTREME EXHAUST SYSTEM - SIDE EXIT, BLACK CHROME TIPS	66	\$1,395.00
M-5200-F1535RECA	2015-2019 F-150 3.5L CAT-BACK EXTREME EXHAUST SYSTEM - SIDE EXIT, CHROME TIPS	66	\$1,395.00
M-5200-F1535RSBA	2015-2019 F-150 3.5L CAT-BACK SPORT EXHAUST SYSTEM - SIDE EXIT, BLACK CHROME TIPS	66	\$1,395.00
M-5200-F1535RSCA	2015-2019 F-150 3.5L CAT-BACK SPORT EXHAUST SYSTEM - SIDE EXIT, CHROME TIPS	66	\$1,395.00
M-5200-F1535RTBA	2015-2019 F-150 3.5L CAT-BACK TOURING EXHAUST SYSTEM - SIDE EXIT, BLACK CHROME TIPS	66	\$1,395.00
M-5200-F1535RTCA	2015-2019 F-150 3.5L CAT-BACK TOURING EXHAUST SYSTEM - SIDE EXIT, CHROME TIPS	66	\$1,395.00
M-5200-F1550145C	2011-2014 F-150 5.0L COYOTE CAT-BACK TOURING EXHAUST SYSTEM - 145" WB	68	\$1,195.00
M-5200-F1550145L	2011-2014 F-150 5.0L COYOTE CAT-BACK SPORT EXHAUST SYSTEM - 145" WB	68	\$1,195.00
M-5200-F1550DEBA	2015-2019 F-150 5.0L CAT-BACK EXTREME EXHAUST SYSTEM - REAR EXIT, BLACK CHROME TIPS	66	\$1,395.00
M-5200-F1550DECA	2015-2019 F-150 5.0L CAT-BACK EXTREME EXHAUST SYSTEM - REAR EXIT, CHROME TIPS	66	\$1,395.00
M-5200-F1550DEFA	2015-2019 F-150 5.0L CAT-BACK EXTREME EXHAUST SYSTEM - REAR EXIT, CARBON FIBER TIPS	66	\$1,575.00
M-5200-F1550DSBA	2015-2019 F-150 5.0L CAT-BACK SPORT EXHAUST SYSTEM - REAR EXIT, BLACK CHROME TIPS	66	\$1,395.00
M-5200-F1550DSCA	2015-2019 F-150 5.0L CAT-BACK SPORT EXHAUST SYSTEM - REAR EXIT, CHROME TIPS	66	\$1,395.00
M-5200-F1550DSFA	2015-2019 F-150 5.0L CAT-BACK SPORT EXHAUST SYSTEM - REAR EXIT, CARBON FIBER TIPS	66	\$1,630.00
M-5200-F1550DTBA	2015-2019 F-150 5.0L CAT-BACK TOURING EXHAUST SYSTEM - REAR EXIT, BLACK CHROME TIPS	66	\$1,395.00
M-5200-F1550DTCA	2015-2019 F-150 5.0L CAT-BACK TOURING EXHAUST SYSTEM - REAR EXIT, CHROME TIPS	66	\$1,395.00
M-5200-F1550DTFA	2015-2019 F-150 5.0L CAT-BACK TOURING EXHAUST SYSTEM - REAR EXIT, CARBON FIBER TIPS	66	\$1,630.00
M-5200-F1550REBA	2015-2019 F-150 5.0L CAT-BACK EXTREME EXHAUST SYSTEM - SIDE EXIT, BLACK CHROME TIPS	66	\$1,395.00
M-5200-F1550RECA	2015-2019 F-150 5.0L CAT-BACK EXTREME EXHAUST SYSTEM - SIDE EXIT, CHROME TIPS	66	\$1,395.00
M-5200-F1550RSBA	2015-2019 F-150 5.0L CAT-BACK SPORT EXHAUST SYSTEM - SIDE EXIT, BLACK CHROME TIPS	66	\$1,395.00
M-5200-F1550RSCA	2015-2019 F-150 5.0L CAT-BACK SPORT EXHAUST SYSTEM - SIDE EXIT, CHROME TIPS	66	\$1,395.00
M-5200-F1550RTBA	2015-2019 F-150 5.0L CAT-BACK TOURING EXHAUST SYSTEM - SIDE EXIT, BLACK CHROME TIPS	66	\$1,395.00
M-5200-F1550RTCA	2015-2019 F-150 5.0L CAT-BACK TOURING EXHAUST SYSTEM - SIDE EXIT, CHROME TIPS	66	\$1,395.00
M-5200-F15R145C	2011-2014 F-150 RAPTOR 6.2L CAT-BACK TOURING EXHAUST SYSTEM 145-INCH WB	68	\$1,449.00
M-5200-F15R145L	2011-2014 F-150 RAPTOR 6.2L CAT-BACK SPORT EXHAUST SYSTEM 145-INCH WB	68	\$1,449.00
M-5200-F15RSB	2017-2019 F-150 RAPTOR 3.5L CAT BACK SPORT EXHAUST SYSTEM - BLACK TIPS	67	\$1,985.00
M-5200-F15RSC	2017-2019 F-150 RAPTOR 3.5L CAT BACK SPORT EXHAUST SYSTEM - CHROME TIPS	67	\$1,905.00
M-5200-F15RSCF	2017-2019 F-150 RAPTOR 3.5L CAT BACK SPORT EXHAUST SYSTEM - CARBON FIBER TIPS	67	\$2,300.00
M-5200-F15RTB	2017-2019 F-150 RAPTOR 3.5L CAT BACK TOURING EXHAUST SYSTEM - BLACK TIPS	67	\$1,985.00
M-5200-F15RTC	2017-2019 F-150 RAPTOR 3.5L CAT BACK TOURING EXHAUST SYSTEM - CHROME TIPS	67	\$1,905.00
M-5200-F15RTCF	2017-2019 F-150 RAPTOR 3.5L CAT BACK TOURING EXHAUST SYSTEM - CARBON FIBER TIPS	67	\$2,300.00
M-5200-FRS	2016-2018 FOCUS RS ACTIVE CAT BACK SPORT EXHAUST SYSTEM	58	\$1,810.00
M-5200-FST	2013-2018 FOCUS ST CAT-BACK SPORT EXHAUST SYSTEM	58	\$1,060.00
M-5200-M4EBA	2015-2019 MUSTANG 2.3L ECOBOOST CAT BACK EXTREME EXHAUST SYSTEM - BLACK CHROME TIPS	14	\$1,510.00

PART NUMBER	PART DESCRIPTION	PAGE	RETAIL PRICE
M-5200-M4ECA	2015-2019 MUSTANG 2.3L ECOBOOST CAT BACK EXTREME EXHAUST SYSTEM - CHROME TIPS	14	\$1,510.00
M-5200-M4EFA	2015-2019 MUSTANG 2.3L ECOBOOST CAT BACK EXTREME EXHAUST SYSTEM - CARBON FIBER TIPS	14	\$1,685.00
M-5200-M4SBA	2015-2019 MUSTANG 2.3L ECOBOOST CAT BACK SPORT EXHAUST SYSTEM - BLACK CHROME TIPS	14	\$1,550.00
M-5200-M4SBV	2015-2017 MUSTANG 2.3L CAT BACK SPORT EXHAUST SYSTEM WITH GT350 EXHAUST TIPS & LOWER VALANCE	15	\$2,240.00
M-5200-M4SCA	2015-2019 MUSTANG 2.3L ECOBOOST CAT BACK SPORT EXHAUST SYSTEM - CHROME TIPS	14	\$1,550.00
M-5200-M4SFA	2015-2019 MUSTANG 2.3L ECOBOOST CAT BACK SPORT EXHAUST SYSTEM - CARBON FIBER TIPS	14	\$1,785.00
M-5200-M4TBA	2015-2019 MUSTANG 2.3L ECOBOOST CAT BACK TOURING EXHAUST SYSTEM - BLACK CHROME TIPS	14	\$1,550.00
M-5200-M4TBV	2015-2017 MUSTANG 2.3L CAT BACK TOURING EXHAUST SYSTEM WITH GT350 EXHAUST TIPS & LOWER VALANCE	15	\$2,240.00
M-5200-M4TCA	2015-2019 MUSTANG 2.3L ECOBOOST CAT BACK TOURING EXHAUST SYSTEM - CHROME TIPS	14	\$1,550.00
M-5200-M4TFA	2015-2019 MUSTANG 2.3L ECOBOOST CAT BACK TOURING EXHAUST SYSTEM - CARBON FIBER TIPS	14	\$1,785.00
M-5200-M8	2015-2017 MUSTANG GT 5.0L CAT BACK ACTIVE EXHAUST SYSTEM KIT WITH GT350 EXHAUST TIPS & LOWER VALANCE	11	\$3,169.00
M-5200-M8EBA	2018-2019 MUSTANG GT 5.0L CAT BACK EXTREME EXHAUST SYSTEM - BLACK CHROME TIPS	14	\$1,685.00
M-5200-M8ECA	2018-2019 MUSTANG GT 5.0L CAT BACK EXTREME EXHAUST SYSTEM - CHROME TIPS	14	\$1,685.00
M-5200-M8EFA	2018-2019 MUSTANG GT 5.0L CAT BACK EXTREME EXHAUST SYSTEM - CARBON FIBER TIPS	14	\$2,025.00
M-5200-M8SB	2015-2017 MUSTANG GT 5.0L CAT BACK SPORT EXHAUST SYSTEM - BLACK CHROME TIPS	11	\$1,549.00
M-5200-M8SBA	2018-2019 MUSTANG GT 5.0L CAT BACK SPORT EXHAUST SYSTEM - BLACK CHROME TIPS	14	\$1,785.00
M-5200-M8SBV	2015-2017 Mustang GT 5.0L CAT BACK EXHAUST SYSTEM KIT WITH GT350 EXHAUST TIPS & LOWER VALANCE	12	\$2,460.00
M-5200-M8SC	2015-2017 MUSTANG GT 5.0L CAT BACK SPORT EXHAUST SYSTEM - CHROME TIPS	11	\$1,489.00
M-5200-M8SCA	2018-2019 MUSTANG GT 5.0L CAT BACK SPORT EXHAUST SYSTEM - CHROME TIPS	14	\$1,785.00
M-5200-M8SFA	2018-2019 MUSTANG GT 5.0L CAT BACK SPORT EXHAUST SYSTEM - CARBON FIBER TIPS	14	\$2,265.00
M-5200-M8TB	2015-2017 MUSTANG GT 5.0L CAT BACK TOURING EXHAUST SYSTEM - BLACK CHROME TIPS	12	\$1,549.00
M-5200-M8TBA	2018-2019 MUSTANG GT 5.0L CAT BACK TOURING EXHAUST SYSTEM - BLACK CHROME TIPS	14	\$1,785.00
M-5200-M8TBV	2015-2017 MUSTANG 5.0L CAT-BACK TOURING EXHAUST SYSTEM WITH GT350 TIPS AND LOWER VALANCE	12	\$2,460.00
M-5200-M8TC	2015-2017 MUSTANG GT 5.0L CAT BACK TOURING EXHAUST SYSTEM - CHROME TIPS	12	\$1,489.00
M-5200-M8TCA	2018-2019 MUSTANG GT 5.0L CAT BACK TOURING EXHAUST SYSTEM - CHROME TIPS	14	\$1,785.00
M-5200-M8TFA	2018-2019 MUSTANG GT 5.0L CAT BACK TOURING EXHAUST SYSTEM - CARBON FIBER TIPS	14	\$2,265.00
M-5200-MSS	2015-2019 MUSTANG GT350 ACTIVE CAT BACK SPORT EXHAUST SYSTEM	11	\$2,375.00
M-5200-RA23SB	2019 RANGER 2.3L FORD PERFORMANCE SPORT EXHAUST SYSTEM - SIDE EXIT WITH DUAL BLACK-CHROME TIPS	74	\$1,095.00
M-5200-RA23SC	2019 RANGER 2.3L FORD PERFORMANCE SPORT EXHAUST SYSTEM - SIDE EXIT WITH DUAL CHROME TIPS	74	\$1,095.00
M-5200-SHOTC	2010-2018 TAURUS SHO CAT-BACK TOURING EXHAUST SYSTEM	59	\$1,332.00
M-5220-M8	2015-2019 MUSTANG GT 5.0L SIDE EXIT EXHAUST SYSTEM	13	\$1,219.00
M-5230-FSH	2012-2018 FOCUS HATCHBACK AXLE BACK EXHAUST SYSTEM	58	\$460.00
M-5230-FSHA	2012-2014 FOCUS HATCHBACK ST EXHAUST SYSTEM WITH REAR FASCIA	58	\$476.00
M-5230-GTB	2005-2009 MUSTANG GT SPECIAL EDITION MUSTANG MUFFLER KIT	40	\$529.00
M-5230-M4EBA	2015-2019 MUSTANG 2.3L ECOBOOST EXTREME MUFFLER KIT - BLACK CHROME TIPS	14	\$995.00
M-5230-M4ECA	2015-2019 MUSTANG 2.3L ECOBOOST EXTREME MUFFLER KIT - CHROME TIPS	14	\$995.00
M-5230-M4EFA	2015-2019 MUSTANG 2.3L ECOBOOST EXTREME MUFFLER KIT - CARBON FIBER TIPS	14	\$1,145.00
M-5230-M4SBA	2015-2019 MUSTANG 2.3L ECOBOOST SPORT MUFFLER KIT - BLACK CHROME TIPS	14	\$995.00
M-5230-M4SBV	2015-2017 MUSTANG 2.3L ECOBOOST SPORT MUFFLER KIT WITH GT350 EXHAUST TIPS & LOWER VALANCE	15	\$1,900.00

PART NUMBER	PART DESCRIPTION	PAGE	RETAIL PRICE
M-5230-M4SCA	2015-2019 MUSTANG 2.3L ECOBOOST SPORT MUFFLER KIT - CHROME TIPS	14	\$995.00
M-5230-M4SFA	2015-2019 MUSTANG 2.3L ECOBOOST SPORT MUFFLER KIT - CARBON FIBER TIPS	14	\$1,145.00
M-5230-M4TBA	2015-2019 MUSTANG 2.3L ECOBOOST TOURING MUFFLER KIT - BLACK CHROME TIPS	14	\$995.00
M-5230-M4TBV	2015-2017 MUSTANG 2.3L ECOBOOST TOURING MUFFLER KIT WITH GT350 EXHAUST TIPS & LOWER VALANCE	16	\$1,900.00
M-5230-M4TC	2015-2017 MUSTANG 2.3L ECOBOOST TOURING MUFFLER KIT - CHROME TIPS	15	\$895.00
M-5230-M4TCA	2015-2019 MUSTANG 2.3L ECOBOOST TOURING MUFFLER KIT - CHROME TIPS	14	\$995.00
M-5230-M4TFA	2015-2019 MUSTANG 2.3L ECOBOOST MUSTANG TOURING MUFFLER KIT - CARBON FIBER TIPS	14	\$1,145.00
M-5230-M8EBA	2018-2019 MUSTANG GT 5.0L EXTREME MUFFLER KIT - BLACK CHROME TIPS	14	\$1,095.00
M-5230-M8ECA	2018-2019 MUSTANG GT 5.0L EXTREME MUFFLER KIT - CHROME TIPS	14	\$1,095.00
M-5230-M8EFA	2018-2019 MUSTANG GT 5.0L EXTREME MUFFLER KIT - CARBON FIBER TIPS	14	\$1,395.00
M-5230-M8SBA	2018-2019 MUSTANG GT 5.0L SPORT MUFFLER KIT - BLACK CHROME TIPS	14	\$1,095.00
M-5230-M8SBV	2015-2017 Mustang GT 5.0L SPORT MUFFLER KIT WITH GT350 EXHAUST TIPS & LOWER VALANCE	12	\$2,090.00
M-5230-M8SC	2015-2017 MUSTANG GT 5.0L TOURING MUFFLER KIT - BLACK CHROME TIPS	13	\$895.00
M-5230-M8SCA	2018-2019 MUSTANG GT 5.0L SPORT MUFFLER KIT - CHROME TIPS	14	\$1,095.00
M-5230-M8SFA	2018-2019 MUSTANG GT 5.0L SPORT MUFFLER KIT - CARBON FIBER TIPS	14	\$1,395.00
M-5230-M8TBA	2018-2019 MUSTANG GT 5.0L TOURING MUFFLER KIT - BLACK CHROME TIPS	14	\$1,095.00
M-5230-M8TBV	2015-2017 Mustang GT 5.0L TOURING MUFFLER KIT WITH GT350 EXHAUST TIPS & LOWER VALANCE	13	\$2,090.00
M-5230-M8TC	2015-2017 MUSTANG GT 5.0L TOURING MUFFLER KIT - CHROME TIPS	13	\$895.00
M-5230-M8TCA	2018-2019 MUSTANG GT 5.0L TOURING MUFFLER KIT - CHROME TIPS	14	\$1,095.00
M-5230-M8TFA	2018-2019 MUSTANG GT 5.0L TOURING MUFFLER KIT - CARBON FIBER TIPS	14	\$1,395.00
M-5230-MGTCA1	2011-2014 MUSTANG GT MUFFLER KIT (49 STATE)	40	\$559.99
M-5230-MGTCA30	2011-2014 MUSTANG GT & 2011-2012 GT500 3-INCH EXHAUST SYSTEM	40	\$1,549.00
M-5230-MGTLA	2011-2014 MUSTANG GT/BOSS SPORT MUFFLER KIT (49 STATE)	40	\$774.95
M-5230-MSVTC	2013-2014 MUSTANG GT AXLE BACK QUAD TIP MUFFLERS WITH REAR LOWER VALANCE	41	\$999.00
M-5230-MSVTLA	2011-2012 MUSTANG SHELBY GT500 SPORT MUFFLER KIT (49 STATE)	39	\$799.95
M-5230-MSVTLB	2013-2014 MUSTANG SHELBY GT500 SPORT MUFFLER KIT (49 STATE)	39	\$1,349.00
M-5230-MV6CA	2011-2014 MUSTANG V6 TOURING MUFFLERS (50 STATE)	41	\$795.00
M-5230-MV6LA	2011-2014 MUSTANG V6 SPORT MUFFLERS (49 STATE LEGAL)	41	\$799.95
M-5230-S	2005-2009 MUSTANG GT / 2007-2009 MUSTANG SHELBY GT500 "S" MUFFLER KIT	40	\$639.00
M-5230-V6	2005-2009 MUSTANG V6 TOURING DUAL EXHAUST KIT	41	\$817.00
M-5231-M8	2015-2019 FORD PERFORMANCE BY BORLA GT FORWARD RESONATOR/MUFFLER	16	\$260.00
M-5248-F15I26L	2011-2014 F-150 3.5L ECOBOOST & 5.0L COYOTE 126-INCH WHEELBASE SPORT EXHAUST SYSTEM MID-PIPE	68	\$79.95
M-5248-F15I33C	2011-2014 F-150 5.0L COYOTE 133 INCH WHEELBASE TOURING EXHAUST SYSTEM MID-PIPE	68	\$79.95
M-5248-F15I33L	2011-2014 F-150 3.5L ECOBOOST & 5.0L COYOTE 133-INCH WHEELBASE SPORT EXHAUST SYSTEM MID-PIPE	68	\$79.95
M-5248-F15I57C	2011-2014 F-150 5.0L COYOTE 157 INCH WHEELBASE TOURING EXHAUST SYSTEM MID-PIPE	68	\$79.95
M-5248-F15I57L	2011-2014 F-150 3.5L ECOBOOST & 5.0L COYOTE 157-INCH WHEELBASE SPORT EXHAUST SYSTEM MID-PIPE	68	\$79.95
M-5248-F15I63C	2011-2014 F-150 5.0L COYOTE 163 INCH WHEELBASE TOURING EXHAUST SYSTEM MID-PIPE	68	\$79.95
M-5248-F15I63L	2011-2014 F-150 3.5L ECOBOOST & 5.0L COYOTE 163-INCH WHEELBASE SPORT EXHAUST SYSTEM MID-PIPE	68	\$79.95
M-5248-F15R133	2017-2018 F-150 RAPTOR 3.5L ECOBOOST 133-INCH WHEELBASE EXHAUST SYSTEM MID-PIPE	67	\$207.00
M-5248-F15R133C	2011-2014 F-150 SVT RAPTOR 6.2L 133-INCH WB CAT-BACK TOURING EXHAUST MID-PIPE	68	\$79.95
M-5248-F15R133L	2011-2014 F-150 SVT RAPTOR 6.2L 133-INCH WB CAT-BACK SPORT EXHAUST MID-PIPE	68	\$79.95
M-5251-M8	2015-2019 MUSTANG GT X-PIPE	13	\$274.00
M-5251-MGTA	2011-2014 MUSTANG GT X-PIPE	41	\$259.95

PART NUMBER	PART DESCRIPTION	PAGE	RETAIL PRICE
M-5251-MV6A	2011-2014 MUSTANG V6 X-PIPE	42	\$205.00
M-5251-R	2005-2010 MUSTANG GT X-PIPE	41	\$182.00
M-5300-B	1979-2004 MUSTANG FRONT/REAR SPRING KITS	44	\$269.00
M-5300-C	1979-2004 MUSTANG FRONT/REAR SPRING KITS	44	\$224.00
M-5300-G	1979-2004 MUSTANG FRONT/REAR SPRING KITS	44	\$270.00
M-5300-KA	2005-2014 MUSTANG GT COUPE STREET LOWERING SPRINGS	44	\$221.00
M-5300-L	2007-2014 MUSTANG SHELBY GT500 SPRINGS	45	\$260.00
M-5300-PA	2005-2014 MUSTANG GT TRACK LOWERING SPRINGS	45	\$221.00
M-5300-RA	2013 COBRA JET SPRING KIT	44	\$310.00
M-5300-S	2012-2013 FOCUS LOWERING SPRINGS	61	\$125.00
M-5300-T	2012-2013 BOSS 302 LOWERING SPRINGS	45	\$359.00
M-5300-W	2015-2018 MUSTANG GT350 LOWERING SPRINGS	20	\$373.00
M-5300-X	2015-2019 MUSTANG STREET LOWERING SPRINGS	20	\$387.00
M-5300-Y	2015-2019 MUSTANG TRACK LOWERING SPRINGS	20	\$393.00
M-5478-6M	2015-2019 MUSTANG DRIVESHAFT LOOP	24	\$149.00
M-5478-CJ	COBRA JET DRIVESHAFT LOOP	184	\$159.00
M-5490-A	2005-2014 MUSTANG GT COUPE SWAY BAR KIT	45	\$477.00
M-5490-B	2007-2012 MUSTANG SVT SWAY BAR KIT	45	\$505.00
M-5490-BKA	ANTI-ROLL BAR/SWAY BAR REPLACEMENT BUSHING KIT	45	\$44.00
M-5490-BKB	ANTI-ROLL BAR/SWAY BAR REPLACEMENT BUSHING KIT	45	\$44.00
M-5490-BKC	ANTI-ROLL BAR/SWAY BAR REPLACEMENT BUSHING KIT	45	\$44.00
M-5490-BKD	TRACK SWAY BAR BUSHING KIT	22	\$87.00
M-5490-D	2005-2014 MUSTANG GT CONVERTIBLE SWAY BAR KIT	45	\$469.00
M-5490-G	2015-2019 MUSTANG TRACK SWAY BAR KIT	21	\$540.00
M-5490-HWA	ANTI-ROLL/SWAY BAR COMPLETE HARDWARE KIT	46	\$175.00
M-5490-HWB	ANTI-ROLL/SWAY BAR COMPLETE HARDWARE KIT	46	\$175.00
M-5490-HWC	ANTI-ROLL/SWAY BAR COMPLETE HARDWARE KIT	46	\$175.00
M-5490-LINKA	ANTI-ROLL BAR/SWAY BAR REPLACEMENT END LINK	46	\$91.00
M-5490-LINKB	ANTI-ROLL BAR/SWAY BAR REPLACEMENT END LINK	46	\$91.00
M-5490-LINKC	ANTI-ROLL BAR/SWAY BAR REPLACEMENT END LINK	46	\$91.00
M-5538-A	2005-2014 MUSTANG REAR LOWER CONTROL ARM UPGRADE KIT	48	\$160.00
M-5570-A	2005-2014 MUSTANG JOUNCE BUMPER KIT	44	\$43.24
M-5570-B	2015-2019 MUSTANG JOUNCE BUMPER & HARDWARE KIT	20	\$80.00
M-5638-A	MUSTANG ROAD RACE REAR LOWER CONTROL ARM BUSHINGS	47	\$52.00
M-5638-C	2005-2014 MUSTANG COMPETITION FRONT BUSHING KIT	47	\$595.00
M-5649-R1	2005-2014 MUSTANG TUBULAR REAR LOWER CONTROL ARM KIT - URETHANE BUSHINGS	48	\$214.00
M-5649-S	2005-2014 MUSTANG TUBULAR REAR LOWER CONTROL ARM KIT - SPHERICAL BEARING	48	\$449.95
M-5650-A	2005-2014 MUSTANG LOWER CONTROL ARM RELOCATION BRACKET	48	\$178.00
M-5700-MA	2015-2019 MUSTANG STREET SWAY BAR AND SPRING KIT	21	\$782.00
M-5700-N	2015-2018 MUSTANG GT350 SWAY BAR AND SPRING KIT	21	\$867.00
M-5844210-RS	2016-2018 FOCUS REAR SPOILER KIT	62	\$933.00
M-5970-M	2015-2019 MUSTANG IRS KNUCKLE KIT WITH TOE BEARING	18	\$540.00
M-5972-M	2015-2019 MUSTANG PERFORMANCE PACK REAR TOE LINK KIT	18	\$79.00
M-5A460-M	2015-2019 MUSTANG KNUCKLE TO TOE LINK BEARING ASSEMBLY	18	\$85.00
M-6000-C302	BLACK SATIN VALVE COVERS	189	\$205.00
M-6000-D302	POLISHED ALUMINUM VALVE COVERS	189	\$235.00
M-6000-E302	BLACK SATIN VALVE COVERS	189	\$205.00
M-6000-F302	POLISHED ALUMINUM VALVE COVERS - MUSTANG LOGO	189	\$235.00
M-6000-J302R	BLACK SATIN VALVE COVERS	190	\$205.00
M-6003-A429	HI-PERFORMANCE ENGINE GASKET SET	147	\$142.00
M-6003-A50	HI-PERFORMANCE ENGINE GASKET SET	139	\$137.00
M-6004-462V	4.6L 2V CAMSHAFT DRIVE KIT	106	\$510.00
M-6004-463V	4.6L 3V CAMSHAFT DRIVE KIT	107	\$650.00
M-6004-54SVT	5.4L 4V MUSTANG SVT CAMSHAFT DRIVE KIT	107	\$575.00
M-6004-A464	4.6L 4V CAMSHAFT DRIVE KIT	107	\$615.00
M-6004-A5015	2015-2017 5.0L 4V TI-VCT MUSTANG COYOTE CAMSHAFT DRIVE KIT	96	\$620.00
M-6004-A5018	2018 5.0L 4V TI-VCT MUSTANG COYOTE CAMSHAFT DRIVE KIT	96	\$650.00

PART NUMBER	PART DESCRIPTION	PAGE	RETAIL PRICE
M-6004-A504	2011-2014 5.0L 4V TI-VCT MUSTANG COYOTE CAMSHAFT DRIVE KIT	96	\$670.00
M-6004-A50R	2015-2017 5.0L/5.2L COYOTE HIGH-PERFORMANCE CAM PHASER	94	\$525.00
M-6004-A544	5.4L 4V CAMSHAFT DRIVE KIT	107	\$415.00
M-6004-GT350PC	COYOTE/GT350 PRIMARY TIMING CHAIN SET	94	\$69.00
M-6006-M50A1	GEN 1 5.0L COYOTE LONG BLOCK	87	\$7,500.00
M-6006-M50C	GEN 3 5.0L COYOTE LONG BLOCK	86	\$8,300.00
M-6007-23TA	2.3L 310HP MUSTANG ECOBOOST ENGINE KIT	113	\$6,550.00
M-6007-572DF	572 CUBIC INCH 655 HP BIG BLOCK STREET CRATE ENGINE-FRONT SUMP PAN	145	\$17,795.00
M-6007-572DR	572 CUBIC INCH 655 HP BIG BLOCK STREET CRATE ENGINE-REAR SUMP PAN	145	\$17,795.00
M-6007-A50NAA	GEN 2 5.0L COYOTE ALUMINATOR NA CRATE ENGINE	83	\$10,995.00
M-6007-A50NAB	GEN 3 5.0 COYOTE ALUMINATOR CRATE ENGINE (12.0:1 COMPRESSION RATIO)	81	Coming IQ 2020
M-6007-A50SCA	GEN 2 5.0L COYOTE ALUMINATOR SC CRATE ENGINE	82	\$10,995.00
M-6007-A50SCB	GEN 3 5.0 COYOTE ALUMINATOR CRATE ENGINE (9.5:1 COMPRESSION RATIO)	81	Coming IQ 2020
M-6007-A52XS	5.2L ALUMINATOR 5.2 XS CRATE ENGINE	84	
M-6007-D3475R	347 CUBIC INCH 415 HP SEALED RACING ENGINE	119	\$9,950.00
M-6007-D3475R7	347 CUBIC INCHES 415 HP SEALED RACING ENGINE 7MM VALVES	119	
M-6007-M50C	GEN 3 5.0L COYOTE 460HP MUSTANG CRATE ENGINE	80	\$9,500.00
M-6007-M50CAUTO	GEN 3 5.0L COYOTE 460HP MUSTANG AUTOMATIC TRANSMISSION CRATE ENGINE	80	\$9,500.00
M-6007-5347JR2	347CI 350HP CRATE ENGINE-SEALED RACING X2 CYLINDER HEAD	118	\$9,400.00
M-6007-X2302E	302 CI 340 HP BOSS CRATE ENGINE WITH "E" CAM	117	\$8,700.00
M-6007-X2347DF	X2347D STREET CRUISER-DRESSED CRATE ENGINE WITH X2 HEADS-FRONT SUMP PAN	116	\$10,795.00
M-6007-X2347DR	X2347D STREET CRUISER-DRESSED CRATE ENGINE WITH X2 HEADS-REAR SUMP PAN	116	\$10,795.00
M-6007-Z2363FT	363 CUBIC INCH 507 HP BOSS CRATE ENGINE-Z2 HEADS-FRONT SUMP PAN	120	\$10,650.00
M-6007-Z2363RT	363 CUBIC INCH 507 HP BOSS CRATE ENGINE-Z2 HEADS-REAR SUMP PAN	120	\$10,650.00
M-6007-Z2427FFT	427 CUBIC INCH 535 HP BOSS CRATE ENGINE-Z2 HEADS-FRONT SUMP PAN	121	\$11,500.00
M-6007-Z2427FRT	427 CUBIC INCH 535 HP BOSS CRATE ENGINE-Z2 HEADS-REAR SUMP PAN	121	\$11,500.00
M-6007-Z460FFT	460 CUBIC INCH 575 HP BOSS CRATE ENGINE-FRONT SUMP PAN	122	\$11,000.00
M-6007-Z460FRT	460 CUBIC INCH 575 HP BOSS CRATE ENGINE-REAR SUMP PAN	122	\$11,000.00
M-6009-347	347 CUBIC INCH BOSS SHORT BLOCK	123	\$5,150.00
M-6009-363	363 CUBIC INCH BOSS SHORT BLOCK	123	\$5,199.00
M-6009-427A	427 ALUMINUM SHORT BLOCK	124	\$8,500.00
M-6009-427F	427 CUBIC INCH BOSS SHORT BLOCK	124	\$5,575.00
M-6009-460	460 CUBIC INCH BOSS SHORT BLOCK - WINDSOR SB BASED	125	\$6,595.00
M-6009-A50NAA	5.0L COYOTE ALUMINATOR NA SHORT BLOCK 11.0:1	89	\$6,695.00
M-6009-A50NAB	5.0L COYOTE ALUMINATOR NA SHORT BLOCK 12.0:1	88	Coming IQ 2020
M-6009-A50SCA	5.0L COYOTE ALUMINATOR SC SHORT BLOCK 9.5:1	89	\$6,995.00
M-6009-A50SCB	5.0L COYOTE ALUMINATOR SC SHORT BLOCK 9.5:1	88	Coming IQ 2020
M-6009-B53	5.3L MODULAR STROKER SHORT BLOCK	105	\$6,900.00
M-6010-16K	1.6 LITER 4-CYLINDER KENT ENGINE BLOCK	151	\$1,475.00
M-6010-16L	1.6 LITER 4-CYLINDER LOTUS ENGINE BLOCK	151	\$1,800.00
M-6010-23T	2.3L ECOBOOST MUSTANG ENGINE BLOCK	114	\$675.00
M-6010-A460X	460 SIAMESE BORE CYLINDER BLOCK	145	\$2,965
M-6010-A460XBB	460 SIAMESE BIG BORE CYLINDER BLOCK	145	\$3,125
M-6010-B302BB	BOSS 302 ENGINE BLOCK BIG BORE	128	\$2,350.00
M-6010-B35192BB	BOSS 351 ENGINE BLOCK 9.2 DECK BIG BORE	128	\$2,400.00
M-6010-BOSS302	BOSS 302 ENGINE BLOCK	128	\$2,195.00
M-6010-BOSS35192	BOSS 351 ENGINE BLOCK 9.2 DECK	128	\$2,550.00
M-6010-BOSS35195	BOSS 351 ENGINE BLOCK 9.5" DECK	128	\$2,550.00
M-6010-BOSS351BB	BOSS 351 ENGINE BLOCK 9.5 DECK BIG BORE	128	\$2,650.00
M-6010-BOSS50	5.0L CAST IRON MODULAR BOSS ENGINE BLOCK	105	\$2,075.00
M-6010-M504V	5.0L GEN 1 COYOTE PRODUCTION ENGINE BLOCK	90	\$1,749.00
M-6010-M504VC	5.0L GEN 3 COYOTE PRODUCTION ENGINE BLOCK	90	\$1,095.00
M-6010-M50R	5.0L COYOTE ALUMINUM PERFORMANCE BLOCK	91	\$3,325.00
M-6010-M52A	5.2L GEN 2 COYOTE ALUMINUM ENGINE BLOCK	90	\$3,425.00
M-6010-M52B	5.2L GEN 3 COYOTE ALUMINUM ENGINE BLOCK	90	\$3,650.00
M-6010-M54A	MUSTANG SHELBY GT500 5.4L PRODUCTION ALUMINUM CYLINDER BLOCK	91	\$3,899.00
M-6010-R500	FR9 NASCAR ENGINE BLOCK	152	\$13,150.00
M-6010-Z351	351 ALUMINUM BLOCK 9.5-INCH DECK	125	\$5,600.00

PART NUMBER	PART DESCRIPTION	PAGE	RETAIL PRICE
M-6010-Z35I92	35I ALUMINUM BLOCK 9.2-INCH DECK	127	\$5,600.00
M-6012-C35I	CYLINDER SLEEVE SET FOR M-6010-Z35I BLOCK	127	\$535.00
M-6012-C35I92	CYLINDER SLEEVE SET FOR M-6010-Z35I92 BLOCK	127	\$535.00
M-6014-BOSS	BOSS BLOCK CYLINDER HEAD STUD KIT	129	\$260.00
M-6014-Z304	CYLINDER HEAD STUD KIT	129	\$225.00
M-6017-23T	2.3L ECOBOOST ENGINE CONTROL PACK	161	\$2,050.00
M-6017-35CNTRL	CONTROL PACK - 2013-2016 3.5L ECOBOOST MANUAL TRANSMISSION	161	\$1,899.00
M-6017-504V	CONTROL PACK - 2015-2017 COYOTE 5.0L MANUAL TRANSMISSION	163	\$1,999.00
M-6017-A504VB	CONTROL PACK - 2011-2014 COYOTE 5.0L 4V MANUAL TRANS WITH SPEED DIAL	85	\$1,999.00
M-6017-M50A	CONTROL PACK 2015-2017 COYOTE 5.0L WITH AUTOMATIC TRANSMISSION	162	\$2,149.00
M-6017-M50B	CONTROL PACK - 2018 COYOTE 5.0L MANUAL TRANSMISSION	85	\$2,300.00
M-6017-M50BA	2018-2019 GEN 3 COYOTE CONTROL PACK- AUTOMATIC TRANSMISSION	161	\$2,300.00
M-6026-23BSBP	2.3L ECOBOOST BALANCE SHAFT BLOCK-OFF PLUG	114	\$20.00
M-6026-A	PLUG AND DOWEL KIT	129	\$210.00
M-6026-A46	4.6 LITER ALUMINUM BLOCK PLUG AND DOWEL KIT	106	\$24.95
M-6026-A460	PLUG AND DOWEL KIT	146	\$23.00
M-6026-A50A	5.0L COYOTE BLOCK HARDWARE KIT 2011-17	92	\$90.00
M-6026-B302	ENGINE BLOCK THREADED CORE PLUGS	129	\$29.00
M-6026-C146	PLUG AND DOWEL KIT	106	\$44.00
M-6026-S35I	FORD PERFORMANCE ENGINE BLOCK-CAMSHAFT PLUG KIT	129	\$9.00
M-6031-BOSS50	ENGINE MOUNT BRACKET KIT	106	\$295.00
M-6038-A460	1979-1995 460 FOX ENGINE SWAP MOUNTS	146	\$250.00
M-6038-M	MODULAR AND COYOTE ENGINE SHIPPING AND STORAGE CRADLE	91	\$140.00
M-6038-M50	5.0L COYOTE MOTOR MOUNT KIT	92	\$179.00
M-6049-C460	FORD PERFORMANCE 460 "SPORTSMAN" WEDGE-STYLE CYLINDER HEADS	146	\$1,440.00
M-6049-E1	FR9 NASCAR CYLINDER HEAD	152	\$1,885.00
M-6049-M23	2015-2018 MUSTANG 2.3L ECOBOOST CYLINDER HEAD	114	\$699.00
M-6049-M50B	GEN 3 COYOTE 5.0L CYLINDER HEAD RH	97	\$950.00
M-6049-M52	5.2L GT350 CYLINDER HEAD RH	97	\$1,825.00
M-6049-M52A	5.2L "GEN 2" RH CYLINDER HEAD	97	\$1,995.00
M-6049-M52X	GT350 CYLINDER HEAD RH SEMI FINISHED	98	\$1,350.00
M-6049-SCJ	SUPER COBRA JET CYLINDER HEAD - BARE	146	\$1,050.00
M-6049-SCJA	SUPER COBRA JET CYLINDER HEAD - ASSEMBLED WITH DUAL SPRINGS	146	\$1,400.00
M-6049-SCJB	SUPER COBRA JET CYLINDER HEAD ASSEMBLED WITH DUAL SPRINGS W/DAMPER	146	\$1,500.00
M-6049-X2	302/351W "X2" STREET CRUISER ASSEMBLED ALUMINUM CYLINDER HEAD 64CC	134	\$1,000.00
M-6049-Z2	Z2 289/302/351W ALUMINUM HEAD WITH VELOCITY VANE	134	\$1,275.00
M-6049-Z304D	302/351W "Z-HEAD" ALUMINUM HEAD - BARE 63CC	135	\$1,075.00
M-6049-Z304D7	302/351W "Z-HEAD" ALUMINUM 63CC W/7MM VALVES	135	\$820.00
M-6049-Z304DA	302/351W "Z-HEAD" ALUMINUM - ASSEMBLED 63CC	135	\$1,500.00
M-6049-Z304DA7	302/351W "Z-HEAD" ALUMINUM - ASSEMBLED 63CC WITH 7MM VALVE	135	\$1,525.00
M-6049-Z304P	302/351W "Z-HEAD" ALUMINUM CNC PORTED - BARE 59CC	135	\$950.00
M-6049-Z304PA	302/351W "Z" ALUMINUM CNC PORTED, ASSEMBLED CYLINDER HEAD	133	\$1,750.00
M-6050-M50B	GEN 3 COYOTE 5.0L CYLINDER HEAD LH	97	\$950.00
M-6050-M52	5.2L GT350 CYLINDER HEAD LH	97	\$1,825.00
M-6050-M52A	5.2L "GEN 2" LH CYLINDER HEAD	97	\$1,995.00
M-6050-M52X	GT350 CYLINDER HEAD LH SEMI FINISHED	98	\$1,350.00
M-6051-A302	CYLINDER HEAD GASKET	140	\$86.00
M-6051-A44I	CYLINDER HEAD GASKET	140	\$98.00
M-6051-A44I	CYLINDER HEAD GASKET	147	\$98.00
M-6051-B34I	CYLINDER HEAD GASKET	140	\$95.00
M-6051-B460	CYLINDER HEAD GASKET	147	\$70.00
M-6051-C5I	302/35I HEAD GASKET SET	140	\$32.25
M-6051-CP33I	302/35I HEAD GASKET SET	140	\$89.00
M-6051-D50	302 HEAD GASKET AND BOLT KIT	140	\$49.00
M-6051-R35I	CYLINDER HEAD GASKET	140	\$99.00
M-6051-S33I	302/35I HEADGASKET SET	140	\$88.00
M-6059-460	460 BIG BLOCK TIMING COVER	150	\$195.00
M-6059-A50	289/302/351W SHORT SERPENTINE BELT-FRONT TIMING COVER	142	\$190.00
M-6059-D35I	289/302/351W FRONT TIMING CHAIN COVER	142	\$169.00

PART NUMBER	PART DESCRIPTION	PAGE	RETAIL PRICE
M-6059-M50SC	5.0L COYOTE FRONT COVER FOR SUPERCHARGED APPLICATIONS	101	\$239.00
M-6059-MSC	5.4L/5.8L TIMING COVER FOR S/C APPLICATIONS	108	\$349.00
M-6065-BOSS	BOSS BLOCK HEAD BOLT SET	130	\$139.00
M-6065-D289	HEAD BOLT KIT	130	\$139.00
M-6066-F150SCCK	2018-2019 F-150 5.0L SUPERCHARGER	77	\$7,800.00
M-6066-M8	2018-2019 MUSTANG GT SUPERCHARGER KIT 700 HP	7	\$7,699.00
M-6066-M8627	2015-2017 MUSTANG GT SUPERCHARGER KIT 670 HP	7	\$7,100.99
M-6067-3V46	4.6L 3V HEAD CHANGING KIT	108	\$105.00
M-6067-3V50	5.0L 3V HEAD CHANGING KIT	108	\$439.00
M-6067-50B302	5.0L COYOTE COIL COVER BOSS 302	101	\$239.00
M-6067-50BK	5.0L COYOTE BLACK COIL COVER - FORD RACING LOGO	101	\$300.00
M-6067-50C	5.0L COYOTE CHROME COIL COVER - FORD RACING LOGO	101	\$399.00
M-6067-50FP	5.0L COYOTE BLUE COIL COVER - FORD PERFORMANCE LOGO	101	\$300.00
M-6067-50FPB	5.0L COYOTE BLACK COIL COVER - FORD PERFORMANCE LOGO	101	\$300.00
M-6067B-F150	5.0L COYOTE CAM COVER BALL STUD KIT	102	\$25.00
M-6067-C	2007-2014 MUSTANG SVT COIL COVERS	112	\$108.95
M-6067-D	4.6L/5.4L 4V "FORD RACING" CAST COIL COVERS	112	\$289.00
M-6067-D46	4.6L 2V SOHC HEAD CHANGING KIT	108	\$160.00
M-6067-M50	5.0L COYOTE HEAD CHANGING KIT-11MM HEAD BOLTS - 2015-2017	98	\$180.00
M-6067-M501280	5.0L/5.2L COYOTE 12MM LONG HEAD BOLT KIT	98	\$120.00
M-6067-M5018	5.0L COYOTE HEAD CHANGING KIT-12MM HEAD BOLTS - 2018	98	\$200.00
M-6067-M5052	5.0L COYOTE HEAD CHANGING KIT - 5.2L HEAD ON 5.0L BLOCK	98	\$160.00
M-6067-M50BR	BOSS 302R HEAD CHANGING KIT - 12 MM HEAD BOLTS	98	\$160.00
M-6067-M50BR11	BOSS 302R HEAD CHANGING KIT - 11 MM HEAD BOLTS	98	\$180.00
M-6067-M52	5.2L COYOTE HEAD CHANGING KIT	99	\$200.00
M-6067-M52B	5.2L "GEN 2" HEAD CHANGING KIT	98	\$175.00
M-6067-M52S	5.0L/5.2L ALUMINUM CAM COVER-PAIR	99	\$255.00
M-6067-M58	5.8L 4V S/C HEAD CHANGING KIT	108	\$180.00
M-6067-MSVT	5.4L 4V S/C HEAD CHANGING KIT	108	\$165.00
M-6067-T46	4.6L 4V HEAD CHANGING KIT	109	\$160.00
M-6200-716	S347/D347SR/D347SR7 CONNECTING ROD SET W/7/16" ROD BOLTS	129	\$520.00
M-6250-23EBH	2015-2018 2.3L ECOBOOST HIGH PERFORMANCE CAMS	114	\$200.00
M-6250-B303	SMALL BLOCK V-8 HYDRAULIC ROLLER TAPPET CAMSHAFTS	137	\$375.00
M-6250-E303	SMALL BLOCK V-8 HYDRAULIC ROLLER TAPPET CAMSHAFTS	137	\$375.00
M-6250-F303	SMALL BLOCK V-8 HYDRAULIC ROLLER TAPPET CAMSHAFTS	137	\$375.00
M-6250-X303	SMALL BLOCK V-8 HYDRAULIC ROLLER TAPPET CAMSHAFTS	137	\$375.00
M-6253-A50	ROLLER CAM CONVERSION KIT	137	\$75.00
M-6261-A460	CAMSHAFT BEARINGS - ROLLER (SOLD IN ENGINE SETS)	148	\$59.00
M-6261-D35I	CAMSHAFT BEARINGS - ROLLER (SOLD IN ENGINE SETS)	129	\$89.00
M-6261-J35I	CAMSHAFT BEARINGS	129	\$99.00
M-6266-54ST	5.4L 4V Steel Timing Chain Tensioner Kit	109	\$175.00
M-6266-M50B	5.0L COYOTE BOSS 302 TIMING CHAIN TENSIONERS	100	\$152.00
M-6268-A302	302/351W DOUBLE ROLLER TIMING CHAIN SET - CAST IRON GEAR	138	\$159.00
M-6268-A35I	351C DOUBLE ROLLER TIMING CHAIN SET	138	\$199.00
M-6268-A390	390/427/428 DOUBLE ROLLER TIMING CHAIN SET	148	\$140.00
M-6268-A460	429-460 DOUBLE ROLLER TIMING CHAIN SET	148	\$185.00
M-6268-B302	302-351W DOUBLE ROLLER TIMING CHAIN SET-STEEL GEAR	138	\$135.00
M-6268-B429	429-460 DOUBLE ROLLER TIMING CHAIN SET	148	\$129.00
M-6269-A302	302-351W CAMSHAFT THRUST PLATE	130	\$50.00
M-6269-A35I	CAMSHAFT THRUST PLATE	130	\$52.00
M-6279-463V	4.6L 3V CAMSHAFT BOLT	109	\$35.95
M-6287-B302	FUEL PUMP ECCENTRIC	138	\$84.00
M-6287-C302	FUEL PUMP ECCENTRIC	138	\$84.00
M-6297-M50A	5.0L COYOTE HIGH STRENGTH VCT SOLENOIDS	104	\$95.00
M-6303-23EB	2015-2018 2.3L ECOBOOST CRANKSHAFT	114	\$419.00
M-6303-C340	HIGH STRENGTH FORGED STEEL 3.40" STROKER CRANKSHAFT	130	\$765.00
M-6303-M50B	5.0L COYOTE MUSTANG FORGED CRANK	92	\$485.00
M-6303-M50RF	COYOTE CRANKSHAFT RAW FORGING	92	\$189.00



PART NUMBER	PART DESCRIPTION	PAGE	RETAIL PRICE
M-6303-M52	COYOTE 5.2L FORGED CRANKSHAFT	92	\$1,250.00
M-6304-DPIC	DIGITAL PERFORMANCE INFORMATION CENTER GAUGE	187	\$225.00
M-6304GPACK-MA	FORD RACING MUSTANG GAUGE PACK	187	\$1,449.00
M-6304GPOD-A	FORD PERFORMANCE MUSTANG DASH GAUGE POD	187	\$175.00
M-6306-M50A	5.0L/5.2L HIGH STRENGTH FORGED STEEL CRANKSHAFT SPROCKET	92	\$50.00
M-6316-A460	CRANKSHAFT DAMPER	148	\$390.00
M-6316-A50	CRANKSHAFT DAMPER	130	\$440.00
M-6316-A521	CRANKSHAFT DAMPER	148	\$445.00
M-6316-C351	CRANKSHAFT DAMPER	130	\$369.00
M-6316-D302	302/351W PERFORMANCE CRANKSHAFT DAMPER	130	\$370.00
M-6316-M50	5.0L CRANKSHAFT DAMPER KIT	130	\$100.00
M-6345-A46	4.6L 3V ALUMINUM BLOCK MAIN CAP BOLT KIT	106	\$59.00
M-6345-M52	5.2L/5.0L MAIN BOLT KIT	92	\$40.00
M-6359-D460	460/514 CRANKSHAFT DAMPER SPACER	149	\$67.00
M-63660005-MF	2018-2019 MUSTANG "FORD PERFORMANCE" LOGO RECARO SEAT SET	26	\$3,947.00
M-6373-A	STARTER INDEX PLATE MODULAR BLOCK AUTOMATIC TRANSMISSION	173	\$55.00
M-6375-A302AB	MANUAL TRANSMISSION FLYWHEEL ALUM 157T 28.2	174	\$429.00
M-6375-A302B	MANUAL TRANSMISSION FLYWHEEL STEEL 157 28.2	174	\$297.00
M-6375-A50C	5.0L COYOTE AUTOMATIC TRANSMISSION FLEXPLATE AND BOLTS	103	\$80.00
M-6375-B302	MANUAL TRANSMISSION FLYWHEEL	174	\$219.00
M-6375-C302B	MANUAL TRANSMISSION FLYWHEEL STEEL 157T 50	174	\$299.00
M-6375-D302AB	MANUAL TRANSMISSION FLYWHEEL ALUMINUM 157T 0	174	\$469.00
M-6375-D302B	MANUAL TRANSMISSION FLYWHEEL STEEL 157T 0	174	\$295.00
M-6375-D46	4.6L 2V 6 BOLT NODULAR IRON MUSTANG FLYWHEEL	175	\$195.00
M-6375-F46A	4.6L 6 BOLT BILLET STEEL MUSTANG FLYWHEEL	175	\$350.00
M-6375-G46A	4.6L 8 BOLT BILLET STEEL MUSTANG FLYWHEEL	175	\$369.00
M-6375-K302	MANUAL TRANSMISSION FLYWHEEL BILLET STEEL 164T 28.2	174	\$369.00
M-6375-M302	MANUAL TRANSMISSION FLYWHEEL BILLET STEEL 164T 0 OZ.-IN.	174	\$369.00
M-6375-M50	FLYWHEEL LIGHTWEIGHT BILLET 8 BOLT MODULAR-COYOTE	175	\$369.00
M-6375-N427	MANUAL TRANSMISSION FLYWHEEL BILLET STEEL 184T 0 OZ.-IN.	174	\$369.00
M-6375-R00A	4.6L 8 BOLT ALUMINUM MUSTANG FLYWHEEL	175	\$489.00
M-6379-B	4.6L MANUAL FLYWHEEL BOLTS	173	\$14.95
M-6379-C	5.0L COYOTE FLYWHEEL BOLT KIT	173	\$16.50
M-6379-M50A	5.0L COYOTE AUTOMATIC TRANSMISSION FLEXPLATE BOLTS	103	\$32.00
M-6392-E	302/351 T-5 BELLHOUSING	172	\$359.00
M-6392-M46	4.6L/5.0L/5.4L MODULAR BELLHOUSING	173	\$650.00
M-6392-R58	302/351 BELLHOUSING FOR TREMEC® 5-SPEED	173	\$345.00
M-6397-A302	10.5" PRESSURE PLATE BOLT AND DOWEL KIT	173	\$18.95
M-6397-B46	11" PRESSURE PLATE BOLT AND DOWEL KIT	173	\$21.00
M-6500-GT	FORD GT AND 5.4L GT500 LASH ADJUSTERS	109	\$310.00
M-6500-M50	5.0L COYOTE LASH ADJUSTER ASSEMBLY KIT	99	\$345.00
M-6500-R302	HYDRAULIC ROLLER CAM LIFTERS	138	\$141.95
M-6500-R302H	HIGH PERFORMANCE HYDRAULIC ROLLER CAM LIFTERS	138	\$220.00
M-6500-R302HLC	HIGH PERFORMANCE HARDENED STEEL LIFTER CUP-SET OF 16	138	\$230.00
M-6505-A429	EXHAUST VALVE	147	\$19.00
M-6505-B304	EXHAUST VALVE 302/351W	136	\$19.00
M-6505-D3047	EXHAUST VALVE 7MM	136	\$18.50
M-6505-FP350S	5.2L CYLINDER HEAD VALVE TRAIN KIT	104	\$1,900.00
M-6505-G302	EXHAUST VALVE	135	\$14.25
M-6505-M52	EXHAUST VALVE LIGHTWEIGHT 5.2L COYOTE - QTY 8	99	\$130.00
M-6507-A304	INTAKE VALVE	136	\$19.00
M-6507-B429	INTAKE VALVE	147	\$19.00
M-6507-D3047	INTAKE VALVE 7MM	136	\$18.50
M-6507-J302	INTAKE VALVE	135	\$17.50
M-6507-M52	INTAKE VALVE LIGHT WEIGHT 5.2L COYOTE - QTY 8	99	\$240.00
M-6510-XRBVG	BRONZE VALVE GUIDE KIT	135	\$32.00
M-6513-1219X	PAC 1219X BEEHIVE VALVE SPRING	136	\$195.00
M-6513-M50BR	BOSS 302R VALVE SPRING KIT	99	\$66.00
M-6513-M52	5.2L COYOTE VALVE SPRING KIT	99	\$185.00
M-6514-A50	VALVE SPRING RETAINERS	136	\$54.00
M-6529-3V	MODULAR 3V ROCKER ARM AND LASH ADJUSTER KIT	109	\$385.00
M-6529-A302	VALVE ROCKER ARM PEDESTAL SHIM KIT	139	\$11.00

PART NUMBER	PART DESCRIPTION	PAGE	RETAIL PRICE
M-6529-B302	ROCKER ARM PEDESTAL SHIM KIT	139	\$15.95
M-6529-MSVT	MUSTANG SVT 5.4L MODULAR ROCKER ARM SET	109	\$309.00
M-6550-3V	2005-2010 MUSTANG GT HIGH LIFT HOT ROD CAM SET	110	\$959.00
M-6550-M50BEXH	2012-2013 BOSS 302 EXHAUST CAM SET FOR COYOTE 5.0L	96	\$950.00
M-6550-M50BINT	2012-2013 BOSS 302 INTAKE CAM SET FOR COYOTE 5.0L	96	\$700.00
M-6550-M52	GEN 2 COYOTE 5.2L HIGH PERFORMANCE CAMS	97	\$1,800.00
M-6550-M52A	GEN 1 COYOTE 5.2L HIGH PERFORMANCE CAMS	97	\$1,800.00
M-6564-M50	5.0L COYOTE ROLLER FINGER FOLLOWER KIT	100	\$199.00
M-6564-M52	5.2L COYOTE ROLLER FINGER FOLLOWER KIT	100	\$595.00
M-6566-SCJA	SCJ VALVE PUSH ROD PLATE - FITS ONE CYLINDER HEAD	136	\$69.00
M-6566-Z304D	VALVE PUSHROD GUIDEPLATE	136	\$58.00
M-6571-A50	VALVE STEM SEALS POSITIVE-TYPE, GUIDE-MOUNTED SEAL	135	\$28.00
M-6580-M50	5.0L COYOTE TIMING/FRONT COVER AND CAM COVER KIT	101	\$510.00
M-6582-16K	4 CYLINDER KENT VALVE COVER	151	\$139.00
M-6582-A	BLACK SATIN VALVE COVER	187	\$199.95
M-6582-A301R	BLACK SATIN VALVE COVER	188	\$199.95
M-6582-A302R	POLISHED ALUMINUM VALVE COVER	188	\$189.00
M-6582-A341R	BLACK SATIN VALVE COVER	190	\$239.95
M-6582-A342R	POLISHED ALUMINUM VALVE COVER	190	\$249.95
M-6582-A351R	BLACK SATIN TRUCK VALVE COVERS	190	\$199.95
M-6582-A427	POLISHED ALUMINUM VALVE COVER	190	\$255.00
M-6582-B	BLACK SATIN VALVE COVER	190	\$249.00
M-6582-B301	BLACK SATIN VALVE COVER	189	\$199.95
M-6582-B460	460 ALUMINUM VALVE COVER SATIN BLACK	190	\$299.00
M-6582-C351BK	BLACK SATIN VALVE COVERS	190	\$239.95
M-6582-C351PD	POLISHED ALUMINUM VALVE COVERS	191	\$249.95
M-6582-C460	POLISHED ALUMINUM VALVE COVER	191	\$249.00
M-6582-CT2	289/302/351W Circle Track Valve Covers	188	\$255.00
M-6582-F302	BLACK SATIN VALVE COVER	188	\$199.95
M-6582-FR3VBL	BLUE FORD RACING COATED 3-VALVE CAM COVERS	112	\$415.00
M-6582-FR3VBLK	BLACK FORD RACING COATED 3-VALVE CAM COVERS	112	\$415.00
M-6582-LE302BK	BLACK SATIN VALVE COVERS	188	\$199.95
M-6582-LE302BL	BLUE SATIN VALVE COVERS	188	\$199.95
M-6582-LE302SBK	BLACK SATIN VALVE COVERS	188	\$199.95
M-6582-W351PR	289-302-351W SB FORD RACING BLACKRIBBED ALUMINUM VALVE COVER	191	\$229.00
M-6582-W427B	BLACK SATIN SMALL BLOCK 427 VALVE COVER	189	\$195.00
M-6582-Z351	POLISHED ALUMINUM VALVE COVER	190	\$249.00
M-6582-Z351B	CLEVELAND BLACK ALUMINUM VALVE COVER	190	\$275.00
M-6584-A50	VALVE ROCKER ARM COVER GASKET	141	\$40.95
M-6588-A50	ROCKER CHANNEL KIT	139	\$27.75
M-6600-50	5.0L/5.2L COYOTE LOW VOLUME OIL PUMP	93	\$76.00
M-6600-50CJ	5.0L TI-VCT BILLET STEEL GEROTOR OIL PUMP	93	\$805.00
M-6600-A460	429/460 HIGH VOLUME OIL PUMP	149	\$99.00
M-6600-A50PKIT	5.0L COYOTE OIL PUMP INSTALLATION KIT	93	\$80.00
M-6600-B3	351W HIGH VOLUME OIL PUMP	131	\$75.00
M-6600-D2	289/302 HIGH VOLUME OIL PUMP	131	\$65.00
M-6600-D46	4.6L HIGH VOLUME OIL PUMP AND PICKUP TUBE	106	\$99.00
M-6600-M50A	5.0L/5.2L BILLET STEEL GEROTOR OIL PUMP GEAR SET	94	\$419.00
M-6605-A341	351W OIL PUMP DRIVE SHAFT	131	\$38.00
M-6605-A429	429/460 OIL PUMP DRIVE SHAFT	149	\$38.00
M-6605-B302	289/302 OIL PUMP DRIVE SHAFT	131	\$38.00
M-6622-302	302 ENGINE-UNIVERSAL OIL DIPSTICK/TUBE	95	\$25.00
M-6622-BOSS302	BOSS 302 OIL PICKUP TUBE	131	\$125.00
M-6622-DRS302	302 DEEP REAR SUMP OIL PICKUP TUBE	132	\$96.00
M-6622-DRS351	351 DEEP REAR SUMP OIL PICKUP TUBE	132	\$96.00
M-6622-DRS351A	351 DEEP REAR SUMP OIL PICKUP TUBE FOR Z351 ALUMINUM BLOCK	131	\$95.00
M-6622-DRS460	460 DEEP REAR SUMP OIL PICKUP TUBE	149	\$37.00
M-6622-FT302	302 FRONT SUMP OIL PAN PICKUP TUBE	132	\$159.00
M-6622-FT351	351 FRONT SUMP OIL PAN PICKUP TUBE	132	\$150.00
M-6622-FT460	460 FRONT SUMP OIL PAN PICKUP TUBE	149	\$37.00
M-6622-M50RR	Oil Sump Pickup Tube	95	\$105.00
M-6622-M52RR	Oil Sump Pickup Tube	95	\$299.00
M-6642-MB	MUSTANG BOSS 302 ENGINE OIL COOLER	93	\$180.00
M-6674-302	289-302 SB OIL PAN REINFORCEMENT RAILS	133	\$89.00
M-6674-351	351W OIL PAN REINFORCEMENT RAILS	133	\$89.00
M-6675-A460	460 ENGINE SWAP OIL PAN KIT	150	\$235.00
M-6675-A50	302/5.0L ENGINE SWAP OIL PAN KIT	131	\$235.00

PART NUMBER	PART DESCRIPTION	PAGE	RETAIL PRICE
M-6675-A58	351W/5.8L ENGINE SWAP OIL KIT	131	\$175.00
M-6675-DRS302	302 DEEP REAR SUMP OIL PAN	132	\$560.00
M-6675-DRS351	351 DEEP REAR SUMP OIL PAN	132	\$555.00
M-6675-DRS460	460 DEEP REAR SUMP OIL PAN	149	\$775.00
M-6675-FT302	302 FRONT T-SUMP RACING OIL PAN	132	\$585.00
M-6675-FT351	351 FRONT T-SUMP RACING OIL PAN	132	\$599.00
M-6675-FT460	460 FRONT SUMP OIL PAN	149	\$939.00
M-6675-M50A1	2017 GEN 2 5.0L COYOTE OIL PAN KIT	93	\$85.00
M-6675-M50BR	2011-2017 5.0L COYOTE 4V TI-VCT RACE OIL PAN	95	\$1,300.00
M-6675-M52	5.2L Coyote GT350 Oil Pan and Pump Kit	95	\$625.00
M-6675-M52RR	COYOTE 5.0L/5.2L ROAD RACE OIL PAN	94	\$1,425.00
M-6701-A460	429/460 CRANKSHAFT REAR MAIN OIL SEAL	150	\$23.00
M-6701-B302	302 ONE PIECE REAR MAIN OIL SEAL	139	\$18.00
M-6701-B351	351W ONE PIECE REAR MAIN OIL SEAL	139	\$13.50
M-6710-A351	351W/5.8L ONE-PIECE RUBBER OIL PAN GASKET	141	\$32.00
M-6710-A460	429/460 ONE-PIECE RUBBER OIL PAN GASKET	150	\$45.00
M-6710-A50	289/302 ONE-PIECE RUBBER OIL PAN GASKET	141	\$24.50
M-6731-FL1A	CASE OF FORD RACING HIGH PERFORMANCE OIL FILTERS	133	\$195.00
M-6731-FL820	CASE OF FORD RACING HIGH PERFORMANCE OIL FILTERS	133	\$198.00
M-6750-C303	ENGINE OIL DIPSTICK/TUBE	133	\$33.00
M-6750-D303	C4 A.T. DIPSTICK/TUBE	171	\$33.00
M-6750-E303	C6 A.T. DIPSTICK/TUBE	171	\$33.00
M-6766-A23	2.3L MUSTANG ECOBOOST OIL-AIR SEPARATOR LH	10	\$270.00
M-6766-A23S	2.3L MUSTANG ECOBOOST OIL-AIR SEPARATOR RH	10	\$295.00
M-6766-A50	5.0L/5.2L COYOTE OIL-AIR SEPARATOR RH	9	\$207.00
M-6766-A50A	2018-2019 5.0L COYOTE OIL-AIR SEPARATOR RH	10	\$215.00
M-6766-A50S	5.2L GT350 OIL-AIR SEPARATOR LH	10	\$207.00
M-6766-A52	5.2L GT500 OIL-AIR SEPARATOR RH	10	\$489.00
M-6766-FRNVBK	BLACK BREATHER CAP W/ FORD RACING LOGO	191	\$18.00
M-6766-FRNVBL	BLUE BREATHER CAP W/ FORD RACING LOGO	191	\$16.00
M-6766-FRNVCH	CHROME BREATHER CAP W/ FORD RACING LOGO	191	\$17.00
M-6766-FRVBK	BLACK BREATHER CAP W/ FORD RACING LOGO	191	\$17.00
M-6766-FRVBL	BLUE BREATHER CAP W/ FORD RACING LOGO	191	\$17.00
M-6766-FRVCH	CHROME BREATHER CAP W/ FORD RACING LOGO	191	\$17.00
M-6766-M50A	2015-2019 MUSTANG BILLET ENGINE CAP SET W/ LASER ENGRAVED "FORD PERFORMANCE" LOGO	27	\$212.00
M-6766-M50B	2010-2014 MUSTANG 5.0 BILLET ENGINE CAP SET	52	\$212.69
M-6766-MP46A	CHROMED ALUMINUM OIL FILL CAP COVER FOR 4.6L/5.4L/6.8L	191	\$59.00
M-6775-MSVT	5.4L 4V PERFORMANCE INTERCOOLER	38	\$1,099.00
M-6868-M50	5.2L OIL SQUIRTER BLOCK OFF KIT	104	\$79.00
M-6880-A50	PUSHROD V8 90 DEGREE OIL FILTER ADAPTER	133	\$113.00
M-6880-M501	COYOTE GEN 2 OIL FILTER ADAPTER KIT	95	\$74.00
M-6881-M50	2011-2014 5.0L 4V TI-VCT OIL LINE ADAPTOR	93	\$200.00
M-6881-M50A	2015-2017 5.0L COYOTE OIL LINE ADAPTOR	95	\$240.00
M-6892-F	UNIVERSAL VALVE COVER BREATHER CAP GROMMETS	191	\$10.00
M-6949-3V	2005-2010 MUSTANG GT INTAKE SHROUD	112	\$126.00
M-6P067-M50B	5.0L COYOTE "POWERED BY FORD" BLUE COIL COVERS	102	\$99.95
M-6P067-M50BL	5.0L COYOTE "POWERED BY FORD" BLACK COIL COVERS	102	\$45.00
M-7000-A	T-5 REBUILD KIT	171	\$479.00
M-7000-M8S	MUSTANG GT350 TRANSMISSION WITH PUMP	19	\$4,450.00
M-7003-M6266	TREMEC® 6-SPEED TRANSMISSION (2.66 1ST GEAR/26 SPLINE)	169	\$3,895.00
M-7003-M6295	TREMEC® 6-SPEED TRANSMISSION (2.97 1ST GEAR/26 SPLINE)	169	\$3,895.00
M-7003-M6297	TREMEC® 6-SPEED TRANSMISSION (2.97 1ST GEAR/26 SPLINE)	170	\$3,895.00
M-7003-M6XL	TREMEC® MAGNUM XL TRANSMISSION KIT	170	\$4,495.00
M-7003-R58C	TREMEC® 5-SPEED EXTRA HD TRANSMISSION (CLOSE RATIO)	170	\$3,195.00
M-7003-R58H	TREMEC® 5-SPEED EXTRA HD TRANSMISSION (CLOSE RATIO 26 SPLINE)	171	\$3,195.00
M-7003-Z	TREMEC® UPGRADED SUPER-DUTY T-5 TRANSMISSION	172	\$2,295.00
M-7007-A	STARTER INDEX PLATE MODULAR BLOCK MANUAL TRANSMISSION	174	\$49.00
M-7007-B	STARTER INDEX PLATE SMALL BLOCK MANUAL TRANSMISSION	174	\$69.00
M-7050-A	T-5 BEARING RETAINER (FITS 1983-1993 V8 APPLICATIONS)	172	\$75.00
M-7050-B	T-5 BEARING RETAINER (FITS 1994-1995 V8 APPLICATIONS)	172	\$75.00

PART NUMBER	PART DESCRIPTION	PAGE	RETAIL PRICE
M-7210-FRS	2016-2018 FOCUS RS SHORT THROW SHIFTER	59	\$500.00
M-7210-FS	2012-2014 FOCUS 5-SPEED SHORT THROW SHIFTER	59	\$210.00
M-7210-FST	2013-2018 FOCUS ST SHORT THROW SHIFTER	59	\$473.00
M-7210-M	1979-2004 MUSTANG HURST® T-5/T-45 SHIFTER	172	\$325.00
M-7210-M8A	2015-2019 MUSTANG GT350 SHIFTER KIT - WITHOUT KNOB	16	\$367.00
M-7210-M8C	2015-2019 MUSTANG SHORT THROW SHIFTER KIT	16	\$349.00
M-7210-MA	2015-2019 MUSTANG SHIFTER KIT - WITHOUT KNOB	16	\$260.00
M-7210-MGT	2005-2009 MUSTANG GT SHORT THROW SHIFTER	172	\$315.00
M-7210-MGTB	2011-2014 MUSTANG V6/GT 6 SPEED SHIFTER	172	\$539.00
M-7213-F15CF	2016-2019 F-SERIES CARBON FIBER SHIFT KNOB	69	\$249.00
M-7213-FSTCF	FOCUS ST SHIFT KNOB - CARBON FIBER, BLACK, 6 SPEED	59	\$89.00
M-7213-M8	FORD RACING SHIFT KNOB 6-SPEED	17	\$88.00
M-7213-M8A	FORD PERFORMANCE SHIFT KNOB 6-SPEED	17	\$83.00
M-7213-M8B	MUSTANG BULLITT™ WHITE SHIFT KNOB	17	\$130.50
M-7213-M8SB	FORD PERFORMANCE GT350 SHIFT KNOB 6-SPEED - BLACK	17	\$80.00
M-7213-M8SR	FORD PERFORMANCE GT350 SHIFT KNOB 6-SPEED - RED	17	\$79.00
M-7213-M8SW	FORD PERFORMANCE GT350 SHIFT KNOB 6-SPEED - WHITE	17	\$80.00
M-7213-MCF	2015-2019 MUSTANG CARBON FIBER SHIFT KNOB	17	\$89.00
M-7512-A	2005-2014 MUSTANG HIGH PERFORMANCE CLUTCH FLUID LINE UPGRADE	177	\$359.00
M-7512-B	2015-2019 MUSTANG HIGH PERFORMANCE CLUTCH FLUID LINE UPGRADE	17	\$369.00
M-7515-A	1996-2004 MUSTANG CLUTCH RELEASE LEVER	177	\$85.00
M-7548-A	1979-2004 MUSTANG V8 HD THROWOUT BEARING	176	\$69.95
M-7550-X302	CLUTCH DISC	176	\$159.00
M-7553-A302	1979-1993 V8 MUSTANG CLUTCH LINKAGE UPGRADE KIT	177	\$64.00
M-7553-B302	1982-1995 V8 MUSTANG ADJUSTABLE CLUTCH LINKAGE KIT	177	\$119.00
M-7553-C302	1982-1995 V8 MUSTANG ADJUSTABLE CLUTCH SERVICE CABLE	177	\$60.00
M-7553-D302	1996-2004 V8 MUSTANG ADJUSTABLE CLUTCH LINKAGE KIT	177	\$118.00
M-7553-E302	1996-2004 V8 MUSTANG ADJUSTABLE CLUTCH CABLE	177	\$59.00
M-7554-A	1979-2004 V6 AND V8 MUSTANG TOPSIDE CLUTCH ADJUSTER	177	\$79.00
M-7560-A302N	CLUTCH KIT	176	\$325.00
M-7560-T46	CLUTCH KIT	176	\$590.00
M-7583-A	1982-2004 V8 MUSTANG DOUBLE-HOOK CLUTCH QUADRANT	177	\$59.00
M-7600-A	ROLLER PILOT BEARING FOR 289 / 302 / 351C AND 351W	176	\$14.95
M-7600-B	ROLLER PILOT BEARING 4.6L/5.4L AND 5.0L 4V TIVCT MODULAR ENGINES	176	\$14.95
M-7600-C	ROLLER PILOT BEARING - HIGH LOAD - 4.6L/5.4L/5.0L4	176	\$29.00
M-7771-A	MODULAR BELLHOUSING INSTALLATION KIT	173	\$49.00
M-7843-V8	CHROME V8 BADGE	193	\$14.25
M-8005-M8	2015-2019 MUSTANG GT 5.0L PERFORMANCE GT350 RADIATOR	10	\$620.00
M-8005-MBR	2011-2014 MUSTANG GT BOSS 302 RADIATOR	38	\$785.00
M-8005-MGT	2005-2014 MUSTANG GT ALUMINUM RADIATOR	38	\$772.00
M-8080-A	2005-2010 MUSTANG GT DE-GAS BOTTLE	39	\$201.00
M-8100-A	RADIATOR CAP WITH FORD RACING LOGO	39	\$13.75
M-8200-MBR	2012 MUSTANG BOSS 302S FRONT GRILLE	51	\$382.00
M-8200-MBRA	MODIFIED 2013 BOSS 302S GRILLE	51	\$403.00
M-8291-FP	2015-2017 MUSTANG FORD PERFORMANCE RADIATOR COVER	10	\$105.00
M-8501-460BP	460 BIG BLOCK WATER PUMP BACKING PLATE	150	\$32.25
M-8501-E351S	302-351W STREET ROD SHORT V-BELT WATER PUMP	142	\$185.00
M-8501-F351	302/351W MAXIMUM FLOW ALUMINUM WATER PUMP	143	\$236.00
M-8501-FR9	FR9 WATER PUMP ASSEMBLY	153	\$900.00
M-8501-M50	2011-2018 5.0L/5.2L COYOTE 4-BOLT WATER PUMP	104	\$99.00
M-8501-M50CJ16	ELECTRIC WATER PUMP KIT FOR COYOTE 5.0L	103	\$399.00
M-8501-M52A	5.2L "GEN 2" WATER PUMP KIT	104	\$210.00
M-8501-M58	HIGH PERFORMANCE INTERCOOLER PUMP KIT-COBRA JET - GT500	103	\$325.00
M-8501-MSVT	MUSTANG SHELBY GT500 INTERCOOLER PUMP	103	\$199.00
M-8509-CM	1965-1969 MUSTANG BILLET SINGLE GROOVE PULLEY SET	143	\$270.00
M-8509-DM	1970-1978 MUSTANG BILLET SINGLE GROOVE PULLEY SET	143	\$209.00

PART NUMBER	PART DESCRIPTION	PAGE	RETAIL PRICE
M-8509-EM	1970-1978 MUSTANG BILLET DUAL GROOVE PULLEY SET	143	\$270.00
M-8510-A351	302/351W CRANKSHAFT PULLEY SPACER - 0.350"	131	\$42.00
M-8510-B351	302/351W CRANKSHAFT PULLEY SPACER - 0.950"	131	\$42.00
M-8510-C351	302/351W CRANKSHAFT PULLEY SPACER - 0.875"	131	\$42.00
M-8510-D351	302/351W CRANKSHAFT PULLEY SPACER - 0.909"	131	\$42.00
M-8511-A351	1985-1993 MUSTANG 351W ENGINE SWAP ACCESSORY DRIVE KITS	144	\$79.00
M-8511-A50	1985-1993 MUSTANG A/C ELIMINATOR KIT	144	\$99.00
M-8511-B351	1985-1993 MUSTANG 351W ENGINE SWAP ACCESSORY DRIVE KITS	144	\$120.00
M-8511-M50BR	BOSS 302R 5.0L POWER STEERING PUMP BRACKET	104	\$294.00
M-8592-M90	90 DEGREE THERMOSTAT HOUSING	143	\$79.00
M-8600-M50AC	5.0L COYOTE AIR CONDITIONING KIT	104	\$999.00
M-8600-M50ALTA	HIGH OUTPUT ALTERNATOR KIT COYOTE 5.0L	103	\$470.00
M-8600-M50BALT	MUSTANG BOSS 302 ALTERNATOR KIT	103	\$330.00
M-8604-A50	1979-1993 MUSTANG OFF-ROAD IDLER BRACKET	143	\$102.00
M-8C368-FR9	FR9 WATER OUTLET MANIFOLD	153	\$664.95
M-8C607-MSVT	2005-2014 MUSTANG PERFORMANCE COOLING FAN	104	\$335.00
M-9000-PMCA3	GEN 3 5.0L COYOTE POWER MODULE WITH 10-SPEED AUTOMATIC TRANSMISSION	79	\$17,900.00
M-9000-PMCM3	GEN 3 5.0L COYOTE POWER MODULE WITH 6 SPEED MANUAL TRANSMISSION	79	\$17,900.00
M-9066-M8RHD	2015-2017 MUSTANG GT RIGHT HAND DRIVE SUPERCHARGER CLOSE OUT PANEL KIT	8	\$139.99
M-9275-BFSE	FORD RACING COMPETITION GAUGES - Fuel Pressure	187	\$140.00
M-9278-BFSE	FORD RACING COMPETITION GAUGES - Oil Pressure	187	\$346.01
M-9407-GT05	2005-2009 MUSTANG GT DUAL FUEL PUMP KIT	165	\$869.00
M-9424-463V	4.6L 3V PERFORMANCE INTAKE MANIFOLD	110	\$775.00
M-9424-C460	460/460 FORD PERFORMANCE SINGLE PLANE INTAKE MANIFOLD	148	\$735.00
M-9424-D302	289/302 SINGLE PLANE "VICTOR JR." INTAKE MANIFOLD	141	\$330.00
M-9424-E554	FR9 NASCAR INTAKE MANIFOLD FUEL INJECTED	153	\$600.00
M-9424-E651	FR9 NASCAR INTAKE MANIFOLD NATIONWIDE AND TRUCK SERIES	153	\$625.00
M-9424-F302	289/302 DUAL PLANE INTAKE MANIFOLD	142	\$235.00
M-9424-M50BR	BOSS 302 INTAKE MANIFOLD	100	\$839.00
M-9424-M50CJA	FORD PERFORMANCE COBRA JET 5.0L INTAKE MANIFOLD	100	\$1,310.00
M-9424-M52	GT350 5.2L COYOTE INTAKE MANIFOLD	100	\$1,495.00
M-9424-P46	4.6L PERFORMANCE IMPROVEMENT (PI) INTAKE MANIFOLD	110	\$354.00
M-9430-SR50A	2011-2019 5.0L COYOTE STREET ROD CAST IRON EXHAUST MANIFOLDS	79	\$249.00
M-9432-A50	"STAGE 8" LOCKING HEADER BOLT SYSTEM - 3/8"-16 x 0.75"	42	\$73.00
M-9432-A51	"STAGE 8" LOCKING HEADER BOLT SYSTEM - 3/8"-16 x 1.0"	42	\$80.00
M-9438-35T	F-150 3.5L ECOBOOST TURBOCHARGER UPGRADE KIT	65	\$2,650.00
M-9438-35TA	2013-2016 F-150 3.5L TWIN TURBO UPGRADE KIT	65	\$2,895.00
M-9439-A50	302/351W INTAKE MANIFOLD GASKET	141	\$67.00
M-9439-G50	GRAPHITE INTAKE GASKET FOR STD PORT 302/351W	141	\$13.50
M-9439-ZP	PORTED Z CYLINDER HEAD INTAKE MANIFOLD GASKET	141	\$44.00
M-9444-M50B	BOSS 302 INTAKE MANIFOLD INSTALL KIT	101	\$240.00
M-9448-A462	EXHAUST MANIFOLD GASKETS	110	\$37.00
M-9448-A463V	REPLACEMENT 3V HEADER GASKETS	110	\$37.00
M-9448-A464	EXHAUST MANIFOLD GASKETS	110	\$27.00
M-9448-B302	EXHAUST MANIFOLD GASKETS	141	\$11.95
M-9452-M8	2015-2017 MUSTANG GT PERFORMANCE INTAKE AND CALIBRATION POWER PACK 3	8	\$2,860.00
M-9474-M50	5.0L 4V COYOTE 90MM THROTTLE BODY INTAKE SPACER	165	\$68.00
M-9474-M5087	87MM THROTTLE BODY ADAPTER	165	\$110.00
M-9474-M50B	BOSS 302 90MM THROTTLE BODY INTAKE SPACER	164	\$68.00
M-9486-A50	EFI UPPER-TO-LOWER INTAKE MANIFOLD GASKET	142	\$30.00
M-9486-A51	EFI HEAT SPACER 5" STOCK 5.0L INTAKE	142	\$79.00
M-9486-A52	EFI HEAT SPACER 5" COBRA INTAKE	142	\$88.95
M-9486-A53	EFI HEAT SPACER 1.00" COBRA INTAKE	142	\$99.00
M-9546-67	6.7L DIESEL INJECTOR NOZZLE AND PUMP KIT	65	\$3,250.00
M-9593-G302	FORD PERFORMANCE 47 LB/HR FUEL INJECTOR SET	166	\$369.00
M-9593-LU24A	FORD PERFORMANCE 24 LB/HR FUEL INJECTOR SET	166	\$339.00
M-9593-LU47	FORD PERFORMANCE 47 LB/HR FUEL INJECTOR SET	166	\$457.00
M-9593-LU60	60 LB/HR FUEL INJECTOR SET	166	\$579.00
M-9593-LU80	80 LB/HR FUEL INJECTOR SET	166	\$579.00
M-9593-M39	FORD PERFORMANCE 39 LB/HR FUEL INJECTOR SET	166	\$489.00
M-9593-MU52	52 LB/HR FUEL INJECTOR SET	166	\$415.00

PART NUMBER	PART DESCRIPTION	PAGE	RETAIL PRICE
M-9600-C302	OVAL AIR CLEANER ASSEMBLY (COBRA LOGO)	191	\$119.00
M-9600-CJ	COBRA JET 123 MM BILLET MAF HOUSING	165	\$550.00
M-9600-K302	OVAL AIR CLEANER ASSEMBLY (MUSTANG LOGO)	191	\$127.00
M-9600-SCJ	SUPER COBRA JET 140MM MAF TUNER KIT	165	\$669.00
M-9600-SCJ16	2016 MUSTANG COBRA JET AIR INLET	9	\$329.00
M-9601-B	2005-2009 MUSTANG GT/V6 COLD AIR KIT DISPOSABLE HIGH-FLOW AIR FILTER REPLACEMENT	37	\$33.95
M-9601-C	AIR FILTER ELEMENT	37	\$89.00
M-9601-D	2007-2009 MUSTANG SVT COLD AIR AND SUPERCHARGER UPGRADE KIT REPLACEMENT AIR FILTER	37	\$77.00
M-9601-G	2015-2019 MUSTANG SHELBY GT350 AIR FILTER	11	\$103.00
M-9601-M	2015-2019 MUSTANG GT, I4 AND V6 HIGH-FLOW K&N / FORD PERFORMANCE AIR FILTER	11	\$79.00
M-9601-MGT	2010-2014 MUSTANG GT & 2011-2014 V6 HIGH-FLOW K&N / FORD PERFORMANCE AIR FILTER	37	\$74.00
M-9602-M	FORD PERFORMANCE MUSTANG MAGNARIDE® HANDLING PACK	24	\$969.00
M-9603A-FSTA	2013-2018 FOCUS ST CALIBRATION, SPARK PLUGS AND COLD AIR INTAKE	57	\$873.00
M-9603-FST	2013-2018 FOCUS ST COLD AIR INTAKE KIT	57	\$253.00
M-9603-FSTA	2013-2018 FOCUS ST PERFORMANCE RS COLD AIR INTAKE BOX	58	\$173.01
M-9603-M23	2015-2017 MUSTANG 2.3L COLD AIR INTAKE (NO CAL)	9	\$419.00
M-9603-M4	2015-2017 MUSTANG 2.3L ECOBOOST PERFORMANCE CALIBRATION KIT	9	\$867.00
M-9603-M40	2005-2009 MUSTANG V6 4.0L COLD AIR TUNER KIT (CALIBRATION REQUIRED)	36	\$279.00
M-9603-M4C	2018-2019 MUSTANG ECOBOOST PERFORMANCE CALIBRATION	9	\$635.00
M-9603-M50	2015-2017 MUSTANG 5.0L COLD AIR INTAKE AND THROTTLE BODY (NO CAL)	9	\$549.00
M-9603-M50CJ	5.0L COBRA JET COLD AIR KIT	36	\$475.00
M-9603-M8	2015-2017 MUSTANG GT PERFORMANCE CALIBRATION POWER PACK 1	8	\$720.00
M-9603-M8A	2015-2017 MUSTANG GT COLD AIR INTAKE AND CALIBRATION POWER PACK 2	8	\$1,025.00
M-9603-MBTKA	2012-2013 BOSS 302 MUSTANG TRACKEY	39	\$689.00
M-9603-MGTB	2011-2014 MUSTANG GT FORD PERFORMANCE CALIBRATION WITH HIGH FLOW K&N AIR FILTER	36	\$489.00
M-9603-V605	2005-2009 MUSTANG V6 COLD AIR KIT WITH PERFORMANCE CALIBRATION	37	\$650.00
M-9608-M50SC	2018-2019 MUSTANG SUPERCHARGER COIL COVERS	27	\$310.00
M-9680-BOSS	BOSS INTAKE MANIFOLD/COYOTE ENGINE DRESS UP KIT	102	\$149.00
M-9680-M50	2011-2014 5.0L COYOTE "GEN 1" ENGINE COVER KIT	102	\$185.00
M-9680-M50A	2015-2017 MUSTANG GT COYOTE ENGINE COVER KIT	102	\$185.00
M-9680-M50B	2018 MUSTANG GT COYOTE ENGINE COVER KIT	27	\$189.00
M-9680-M50BA	2018 COYOTE ENGINE DRESS UP KIT	27	\$139.00
M-9926-3V	2005-2010 MUSTANG GT BILLET THROTTLE BODY	164	\$815.00
M-9926-CJ65	2007-2014 SHELBY GT500 DUAL 65 MM THROTTLE BODY	164	\$775.00
M-9926-M2370	2.3L ECOBOOST 70MM BILLET THROTTLE BODY	163	\$695.00
M-9926-M5090	2011-2014 MUSTANG 5.0L 90 MM THROTTLE BODY	164	\$770.00
M-9926-M50B	87MM MUSTANG BULLIT™ THROTTLE BODY	163	\$250.00
M-9926-M52	2015-2017 MUSTANG GT350 THROTTLE BODY 87MM	163	\$249.00
M-9926-MGT	2005-2010 MUSTANG GT THROTTLE BODY	164	\$295.00
M-9926-MSVT	2007-2014 MUSTANG SHELBY GT500 THROTTLE BODY	164	\$235.00
M-9926-SCJM	SUPER COBRA JET MECHANICAL THROTTLE BODY	165	\$795.00
M-BI0677-AA	2005-2016 4X4 SUPER DUTY FRT AXLE KNUCKLE SEAL SHIELD	184	\$68.25
M-FR1-FSTA	2013-2018 Focus ST FRI POWER UPGRADE PACK	57	\$2,107.00
M-FR1-MGTB	2011-2014 MUSTANG GT POWER UPGRADE PACKAGE	35	\$995.00
M-FR3A-M8A	2015-2019 MUSTANG TRACK HANDLING PACK	22	\$1,573.00
M-FR3A-MAA	2015-2019 MUSTANG STREET HANDLING PACK	22	\$1,353.00
M-FR3A-MGTA	2005-2014 MUSTANG GT COUPE ASSEMBLED HANDLING PACK	42	\$1,895.00
M-FR3A-MGTAA	2005-2014 MUSTANG GT COUPE ASSEMBLED HANDLING PACK ADJUSTABLE	42	\$2,350.00
M-FR3A-MSVTA	2007-2014 MUSTANG GT500 COUPE ASSEMBLED HANDLING PACK	43	\$2,200.00
M-FR3-FA	2011-2018 FIESTA HANDLING PACK	61	\$299.95
M-FR3-FASTENA	2015-2019 MUSTANG HANDLING PACK FASTENER KIT	22	\$167.00
M-FR3-FASTENERS	2005-2014 MUSTANG HANDLING PACK FASTENER KIT	43	\$95.00
M-FR3-MSVTA	2007-2014 MUSTANG SVT COUPE HANDLING PACK	43	\$2,165.00
M-TRV-FPRS	2016-2018 FOCUS RS PERFORMANCE TURBO RECIRCULATION VALVE	58	\$159.00
M-TURBO-67	2015-2016 6.7L DIESEL TURBO KIT	65	\$3,040.00



**FORD PERFORMANCE
PARTS**



EXPERT ANSWERS

Need help? We have the answers and information needed to get your Ford Performance components and systems installed and running.

TECHLINE

800.FORD788 (800.367.3788)

313.621.0771 (INTERNATIONAL)

8:30 AM TO 5:00 PM EST MONDAY - FRIDAY

performanceparts.ford.com/contact-us/

DIGITAL RESOURCES

INSTRUCTIONS

performanceparts.ford.com/instruction-sheets

ENGINE & INSTALLMENTS TIPS

performanceparts.ford.com/engine-building-tips



FORD PERFORMANCE
PARTS



GEAR UP, RANGER!

New Parts & Accessories for Ford's Newest Truck

